



Mobile Elevating Work Platform  
Operator Certification  
Alberta OH&S Compliant



© Saga Universal Training Corp 2019

# Mobile Elevating Work Platform Operator Certification Alberta OH&S Compliant

**First Edition**

**December 3, 2019**

No part of this manual may be reproduced in any form or by any means, for any purpose without the express written permission of Saga Universal Training Corporation.

Saga Universal Training Corp. is dedicated to reducing deaths caused by illness and injury. The goal of this program is to ensure operators have the basic knowledge and skills required for the safe operation of their equipment and its attachments. However, due to the different types of Mobile Elevating Work Platforms, certain statements in this program may not apply.

Job and/or familiarization of operators for particular machines or specialized equipment used in specific workplace environments are in addition to this training. It is expected that an employer will take the fundamentals of this training and apply them to their specific machine and workplace.

Readers should not assume that reviewing this manual alone constitutes complete Mobile Elevating Work Platform operator training.

For further information contact:

***Saga Universal Training Corporation***

***E: mail – [info@sagatraining.ca](mailto:info@sagatraining.ca)***

***Web Page – [www.sagatraining.ca](http://www.sagatraining.ca)***

Saga Universal Training Corp. wishes to acknowledge the efforts of all the people who contributed to the writing, editing, and layout of this manual. It is our hope that this manual and the resulting training program will aid in the reduction of preventable injuries and property damage with the necessary knowledge, skills and confidence to operate Mobile Elevating Work Platforms safely.



## Table of Contents

DISCLAIMER .....	7
INTRODUCTION.....	8
RECOMMENDED PRE-REQUISITES: .....	8
CERTIFICATION: .....	8
COURSE GOALS:.....	9
EXPOSURE TO HARM .....	9
CHAPTER 1 OVERSIGHT:.....	14
LEGISLATION.....	16
ALBERTA, OCCUPATIONAL HEALTH AND SAFETY ACT, .....	17
ALBERTA, OCCUPATIONAL HEALTH AND SAFETY REGULATIONS .....	17
ALBERTA, OCCUPATIONAL HEALTH AND SAFETY CODE .....	17
STANDARDS.....	18
DUE DILIGENCE .....	19
BEST PRACTICES .....	20
REQUIREMENT TO COMPLY .....	21
CHAPTER 2: ENSURING A SAFE WORKSITE .....	24
EMPLOYER RESPONSIBILITIES .....	25
EMPLOYEE RESPONSIBILITIES .....	25
KEY ELEMENTS OF A HEALTH AND SAFETY PROGRAM FOR MEWP OPERATORS .....	25
TRAINING AND INFORMATION .....	26
OPERATORS BASIC SAFETY PRACTICES.....	26
EMERGENCY ACTIONS .....	27
JOB PLANNING .....	28
OPERATOR’S MANUAL .....	29
HAZARD ASSESSMENT.....	31
FACILITY DESIGN & WORKPLACE REQUIREMENTS.....	33
SAFE WORK ZONE .....	34

CHAPTER 3: INSPECTIONS AND MAINTENANCE .....	37
MEWP INSPECTION .....	38
CHECKLISTS .....	39
KEY ELEMENTS OF AN INSPECTION CHECKLIST: .....	39
CHECK LIST EXAMPLE .....	39
INSPECTION DEFICIENCIES .....	44
LOCK-OUT / TAG-OUT PROCEDURES .....	44
HOUSEKEEPING .....	46
MAINTENANCE .....	47
MODIFICATIONS .....	47
CHAPTER 4: SAFE OPERATION OF MEWP .....	49
OHS CODE PART 19 – POWERED MOBILE EQUIPMENT .....	50
GENERAL OPERATION .....	50
MACHINE SPECIFIC SAFE OPERATION .....	50
BASIC SAFETY RULES.....	50
FALL PROTECTION.....	52
BASIC OPERATING PROCEDURES .....	54
GENERIC HAND SIGNALS .....	56
ESSENTIAL QUALITIES OF AN EQUIPMENT OPERATOR.....	58
RULES FOR EQUIPMENT OPERATORS.....	59
SPECIAL HAZARDS: .....	60
HYDRAULIC OIL INJECTION INJURY.....	61
TRANSPORTING THE EQUIPMENT SAFELY.....	66
OPERATOR SAFETY.....	68

CHAPTER 5: BASIC OPERATION OF MOBILE ELEVATING WORK PLATFORMS ...	70
CSA CLASSIFICATIONS OF MOBILE ELEVATING WORK PLATFORMS .....	71
BASKET/PLATFORM .....	76
DRIVE .....	77
TIRES AND TRACKS .....	77
STEERING AND TURNING DYNAMICS .....	80
PIVOT POINTS.....	81
STRIKE POINTS .....	81
STABILITY .....	84
STABILITY SHAPES .....	85
CENTER OF GRAVITY OF MACHINE.....	96
FACTORS AFFECTING STABILITY .....	103
ENVELOPE MANAGEMENT SYSTEMS (EMS) .....	105
CENTRIFUGAL FORCE .....	106
CENTRIPETAL FORCE .....	106
WIND .....	107
MOBILE ELEVATING WORK PLATFORMS ON INCLINES .....	107
SIDE SLOPES.....	110
MOBILE ELEVATING WORK PLATFORMS ON SIDE SLOPES.....	111
CAPACITY RESTRICTIONS .....	113

## **DISCLAIMER**

The information contained in this manual is intended to supplement the specific information that is contained in the Mobile Elevating Work Platform (MEWP) manufacturers' operating manual(s).

It is expected that an employer will take the fundamentals of this training and apply them to their specific machine and workplace.

Job and/or familiarization of operators for particular machines or specialized equipment used in specific workplace environments are in addition to this training.

Although every effort is made to ensure the accuracy, currency and completeness of the information, Saga does not guarantee, warrant, represent or undertake that the information provided is correct, accurate or current. Saga is not liable for any loss, claim, or demand arising directly or indirectly from any use or reliance upon the information.

## INTRODUCTION

This course follows the guidelines and standards referenced in the Alberta Occupational Health and Safety Code Part 23 Section 347 and pays particular attention to the principles established by the Canadian Standards Association (CAN3- B354.4 & B354.2), American National Standards Institute (ANSI A92.5-2006 & A92.6-1999), Occupational Safety and Health Administration (CFR1926.453) and recommendations by the Canadian Centre for Occupational Health and Safety (CCOHS).

- The course provides the minimum requirements for the training of operators for Mobile Elevating Work Platforms (MEWPs).
- Due to the different design of equipment classified as Mobile Elevating Work Platforms, certain statements in this program may not apply.
- The course is intended to supplement a company's larger Health & Safety Management System.

Recommended pre-requisites:

- Fall restraint systems training.
- Risk hazard assessment training.
- Basic use of fire extinguisher training.
- Awareness of company specific safety policies, procedures and emergency response plans.
- Familiarity with operator manual for specific elevating work platform to be used on the job.

Certification:

- At the end of each chapter there will be a multiple choice, open-book exam of which, at least 80% correct must be achieved.
- Certificates of training issued by Saga Universal Training Corp. must be recognized by the employer and are valid for 3 years from the date of completion.



### Course Goals:

- The student should understand the relationship between Legislation, Regulations, Standards, Due Diligence, and Best Practices.
- The student will understand the roles and responsibilities of employers and employees and workplace programs as they relate to the operation of MEWP.
- The student will understand the importance of MEWP inspections and how to conduct the inspections safely.
- The student will be familiar with the requirements for the safe operation of MEWP's.
- The student will be familiar with different types of MEWP's, their basic structural components, basic function, potential hazards while operating MEWP and how to control those hazards.

### Exposure to Harm

- Of the millions of workers in Alberta, one worker is exposed to a harm causing injury or illness on average, every 3 minutes.
- Most are new workers within their first year of work.
- Of all the workers in Alberta who have been exposed to harm causing injury or illness, one worker will die from that exposure on average, every second day.
- Most will succumb later in life due to an exposure that occurred earlier in their life.

## Incidents according to Equipment

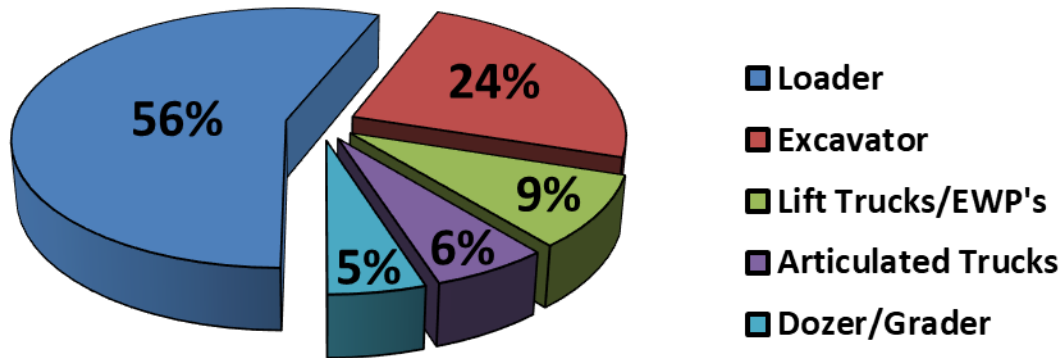

- Of all the workers dying from a workplace exposure, the majority were workers attempting to rescue others.
- Many of them did not have the proper training, equipment, or support to perform the rescue, but felt a moral obligation.
- If a worker is not trained to perform rescue, the worker should be trained not to attempt.
- Operating powered mobile equipment can be one of the most dangerous jobs a worker can have.

## Incidents according to Activity

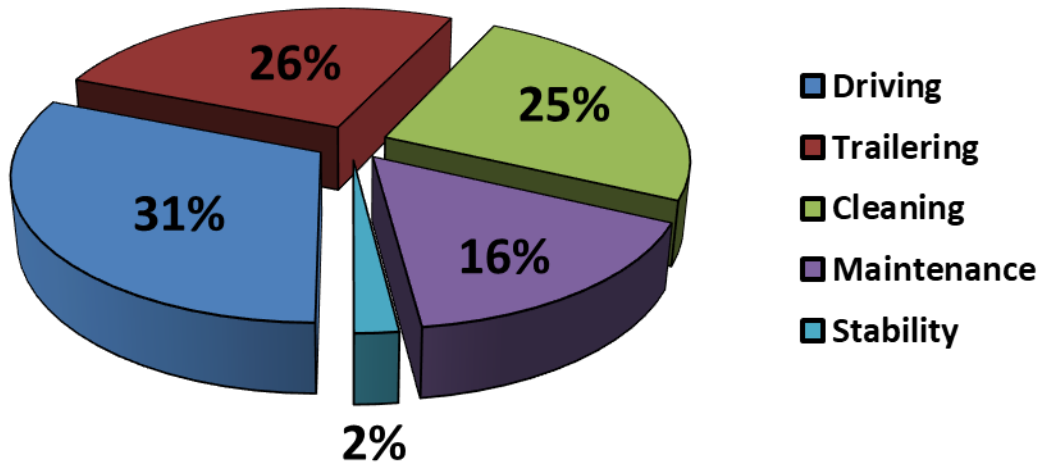

Univ.-Prof. Dr.-Inghabil. H. Tudeshki  
• DiplIng. M. Könnecke

## Recent Fatalities

In 2005/06 falls from height accounted for 46 fatal accidents at work and around 3350 major injuries. They remain the single largest cause of workplace deaths and one of the main causes of major injury.

## UK HSE 2005

Every year, many workers are injured by vehicles and mobile equipment while working in the same area at the same time.

Around 400 workers are killed on the job each year when they are struck by vehicles or mobile equipment. These workers leave behind countless family members. The tragedy here is that these deaths can be prevented. Workers have been killed when struck by vehicles whose drivers did not see them. In many of these cases, the workers killed were standing, walking, or working around vehicles that were backing up.

*-New York FACE Program New York State Department of Health*

Fatal incidents occurred as a result of:

- MEWP collapsing.
- MEWP overturning.
- People being thrown from the carrier.
- The carrier being trapped against fixed structures (the carrier is commonly referred to as the basket or cage).

Primary causes identified:

- Equipment failure.
- Ground conditions.
- Outriggers (not used or faulty).
- Trapping against fixed structure.
- MEWP being struck by vehicle.
- Load/unload of MEWP under power.

Approximately 250 WCB claims per year (BC OH&S) involving MEWP.

After reviewing and analyzing elevated, mobile elevating work platform incidents in construction during the mid '90s, the OSHA Standards Committee deemed it important to include scissor lifts and aerial lifts in the latest (1998) revision of the construction scaffold standard (1926.450). Their investigations revealed that many of contributing unsafe acts and conditions that led up to these particular construction fatalities (1993-1999) were identical in many respects to those of supported scaffold accidents.

The 10 major hazardous activities in elevating work platforms included:

- Operating on an uneven surface.
- Encountering holes, debris and drop-offs while operating with equipment elevated.
- Climbing above or leaning over the 42-inch minimum top rail.
- Overloading and collapsing the boom (i.e. using a man lift as a material crane).
- Making contact with electrical conductors with an un-insulated portion of the lift.
- Neglecting to deploy outriggers or brace sufficiently against tip-over.
- Making body contact with electrical conductors or entering the induction field.
- Operating the lift in inclement weather or low visibility conditions.
- Inexperienced or untrained operators.
- Unobserved, uncorrected mechanical or structural defects in equipment.

While some fatality victims were struck by objects, such as booms and platforms, a smaller percentage was crushed between either the carriage or the platform and some fixed structure.

Falls from the elevated platform seemed to be caused primarily by a worker's unsafe acts, such as leaving gate chains unattached, propping the gate open, or climbing up on or leaning over the guardrail system.

Some even fell from step and extension ladders that were set up inside the platform.

## **CHAPTER 1 OVERSIGHT:**

There are many layers of oversight of safety requirements in the workplace that are often in a hierarchical form of priority. For example, federal laws and regulations normally supersede provincial authority, but in some instances the federal government has given authority to the provinces.

### **Goal:**

The student will have an awareness of the various legislation, regulations, and standards that pertain to Mobile Elevating Work Platforms.

### **Objective:**

1. The student should understand the relationship between Legislation, Regulations, Standards, Due Diligence, and Best Practices.



## Legislation

### Criminal Code of Canada Section 217.1

- One of the farthest-reaching mechanisms of oversight regarding health and safety is Section 217.1 of the Criminal Code of Canada, it is where “due diligence” is defined in law:

“Everyone who undertakes, or has the authority, to direct how another person does work or performs a task is under a legal duty to take reasonable steps to prevent bodily harm to that person, or any other person, arising from that work or task.”

### Canada Labour Code Part II

- In Canada OH&S is a provincial jurisdiction and every province has its own OH&S legislation, code, and regulations.
- However, some industries are federally regulated, which can bring OH&S for those industries under the Canadian Labor Code and under federal jurisdiction.
- Federal health and safety legislation are found in Part II of the Canada Labour Code and Regulations.
- The Canada Labour Code applies to employees of the Federal Government, the Post Office, airports, banks, canals, highway transport, pipelines, radio and television broadcasting, railways, shipping services, and many more.
- All Provinces and Territories must meet the minimum requirements of the Canada Labour Code and Regulations in their own legislation and are certainly encouraged to exceed them.
- Approximately 90% of the Canadian workforce falls under the OH&S legislation of the province or territory in which they work.



## Provincial Legislation and Regulations

The Alberta, Occupational Health and Safety Act, Regulations and Code applies to every occupation, employment and business.

Except for:

- family operated farming and ranching operations, and
- work in, to or around a private dwelling or its' connected land.

Alberta, Occupational Health and Safety Act,

Follow the link below and familiarize yourself with:

- Part 1 Obligations of Worksite parties; Sections 3 thru 13.
- Part 2 Availability of Information; Section 14.
- Part 4 Dangerous Work and Discriminatory Action; Sections 31 thru 36.

[https://www.qp.alberta.ca/1266.cfm?page=O02P2.cfm&leg\\_type=Acts&isbncln=9780779826728](https://www.qp.alberta.ca/1266.cfm?page=O02P2.cfm&leg_type=Acts&isbncln=9780779826728)

Alberta, Occupational Health and Safety Regulations

Follow the link below and familiarize yourself with:

- Part 1 General; Sections 7, and 12 thru 15.

[http://www.qp.alberta.ca/1266.cfm?page=2003\\_062.cfm&leg\\_type=Regs&isbncln=9780779776221&display=html](http://www.qp.alberta.ca/1266.cfm?page=2003_062.cfm&leg_type=Regs&isbncln=9780779776221&display=html)

Alberta, Occupational Health and Safety Code

Follow the link below and familiarize yourself with

- Part 2 Hazard Assessment.
- Part 3 Specifications and Certifications.
- Part 7 Emergency Preparedness and Response.
- Part 9 Fall Protection; Section 156 (1- 4)
- Part 17 Overhead Powerlines.
- Part 18 Personal Protective Equipment.
- Part 23; Section 346 Elevating Platforms and Aerial Devices
- Part 28 Working Alone.

Part 19 – Powered \mobile Equipment

Part 19 has 34 Sections and each section can have as many as 6 sub-sections, and will be reviewed later in the course

## Regulations

- Workplaces must meet the minimum requirements of OH&S Regulations but are also encouraged to exceed them.
- Whether the workplace simply meets or chooses to exceed the minimum of the Provincial regulations, the employer should document their regulations into the company's safe work policies and procedures manual.

## Standards

- OH&S regulations often refer to standards where the regulation will require the worker to follow a specific standard or use equipment that has met the requirements of a specific standard.
- The standards organizations are not the government so they cannot implement regulations.

However, the standards organizations are made up of experts in various disciplines. The standards organizations most frequently referenced in OH&S regulations are:

- CSA Group, formerly the Canadian Standards *Association* (CSA) (CAN/CSA)
- American National Standards Institute (ANSI)

### Others Include:

- American Society of Safety Engineers (ASSE),
- European Committee for Standardization (CEN), or in French: (Comité Européen de Normalisation) Conformité Européenne (CE),
- National Fire Protection Association (NFPA),
- Underwriters Laboratories (UL),
- Underwriters Laboratories of Canada (ULC),
- Safety Equipment Institute (SEI).

For compliance purposes, any equipment required to meet specific standards must bear the mark or label of a nationally accredited testing organization such as CSA or ANSI, as evidence that the equipment has been approved to the requirements of the Standard.



Use caution when purchasing equipment required to meet the various standards. Manufacturers must meet stringent criteria to have their equipment tested to these standards. There have been cases of fraud where equipment has not been tested to the standards criteria and counterfeit marks are placed on the equipment. It is always best to purchase equipment from reputable and authorized dealers.

### The Bottom Line

When a regulation requires certain standards to be followed, they must be followed just as if they were written verbatim in the regulation.

## Due Diligence

- Applied to occupational health and safety, due diligence means that employers shall take all reasonable precautions, under the particular circumstances, to prevent injuries or accidents in the workplace.

Note: The wording is very similar in the Criminal Code of Canada Section 217.1.

## Best Practices

- A best practice is a method or technique that has been generally accepted as superior to any alternatives because it produces results that are superior to those achieved by other means, or because it has become a standard way of doing things.
- Best practices are used to maintain quality as an alternative to mandatory legislated standards and can be based on self-assessment or benchmarking.
- A procedure that has been shown by research and experience to produce optimal results and that is established or proposed as a standard suitable for widespread adoption.
- There are some standards that are not required to be followed by any regulations, but individuals and groups follow them because they produce results.

## Best Practice vs. Due Diligence

- If due diligence in health and safety means to take all reasonable precautions, and best practices are used to maintain quality as an alternative to mandatory legislated standards; then wouldn't following best practices be considered an example of due diligence?
- A standard not required through a regulation but has been generally accepted as superior could be considered a best practice and therefore should be followed to meet due diligence.

Note: Can you think of an example of best practices and due diligence being followed at your worksite?

## Reasonably Practicable

- In OHS the term "reasonably practicable" is frequently used.
- Reasonably practicable is a recognized term that is assessed using the reasonable person test.
- That is, what would a dozen of your peers consider reasonable in similar circumstances.
- Your peers would likely review what you did and compare it to what they do in their own operations.
- Some might do more, others less.

## Requirement to Comply

Notwithstanding the requirement for competency (training and experience), appropriate equipment, and the right to refuse unsafe work:

- If legislation, regulations, or an adopted code imposes a duty on an employer, the employer must ensure that duty is met in accordance with the legislation, regulations, or the adopted code.
- If legislation, regulations, or an adopted code imposes a duty on a worker, the worker must perform that duty, and the employer must ensure the worker performs that duty in accordance with the legislation, regulations, or the adopted code.

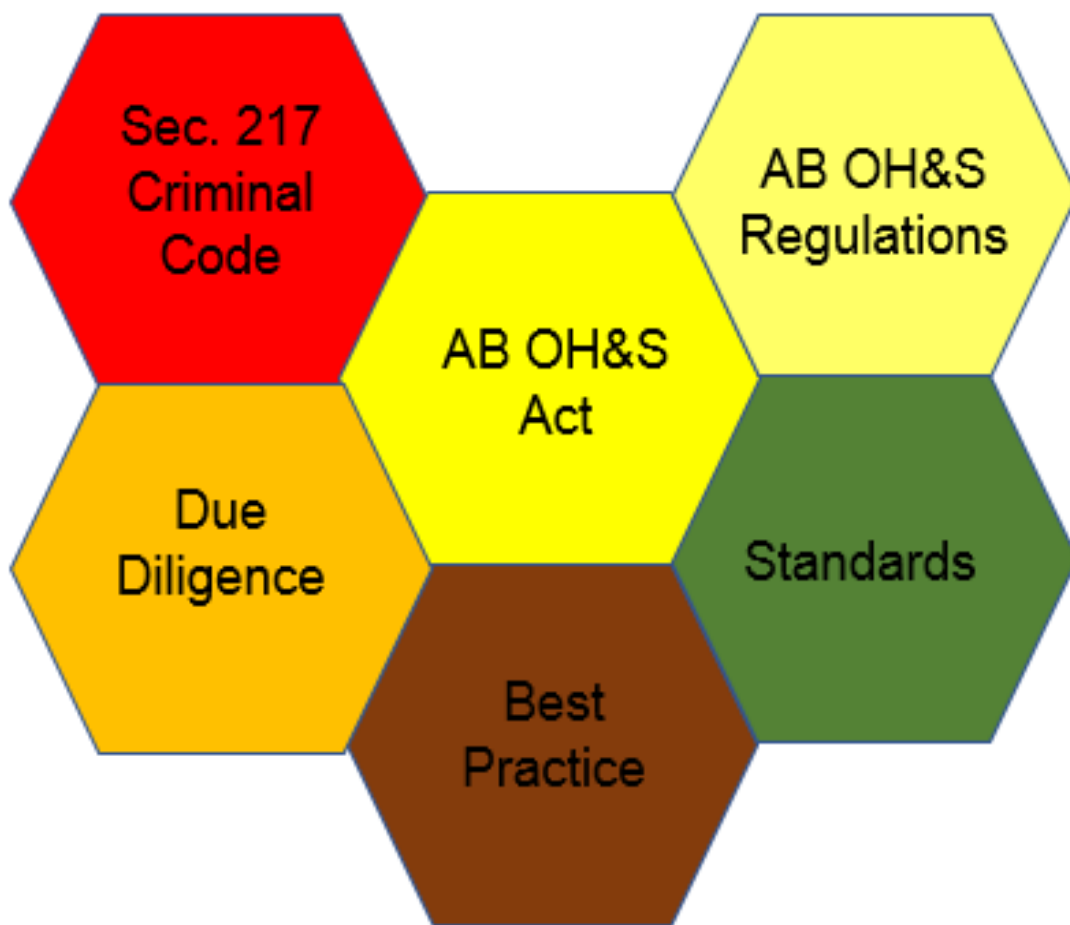

### The Bottom Line

Employers and workers must ensure they understand under which authority they are working and be familiar with the legislation, regulations and standards they must follow.

## Chapter 1 Summary:

What was covered in Chapter 1?

- The relationship between Legislation, Regulations, Standards, Due Diligence, and Best Practices.

## **CHAPTER 2: ENSURING A SAFE WORKSITE**

### **Goal:**

The student will understand the roles and responsibilities of employers and employees and workplace programs as they relate to the operation of MEWP.

### **Objectives:**

1. The student will be aware of employers' responsibilities as they relate to the operation of MEWP.
2. The student will be aware of employees' responsibilities as they relate to the operation of MEWP.
3. The student will be aware of the key elements of a health and safety program for MEWP operators.
4. The student will be aware of requirements of an Emergency Response Plan.
5. The student will be aware of management, and supervision responsibilities as they relate to the operation of MEWP.
6. The student will understand competency requirements as they relate to the operation of MEWP.
7. The student will be aware of the elements of proper job planning and hazard assessment as they relate to the operation of MEWP.
8. Facility Design; students will be aware of workplace requirements.



## Employer Responsibilities

- The primary purpose of OH&S laws is to keep workers safe. Under OH&S laws, employers are ultimately responsible for all persons on their worksite.
- Employers must develop safety policies and procedures for its workers.

## Employee Responsibilities

- Employees must, while at work, make all reasonable efforts to ensure the safety of all persons at the worksite, including other workers, traffic and pedestrians.
- Employees have the obligation to refuse to work on a job or in any workplace, or to operate any equipment if they have reasonable grounds to believe that it would be unsafe or unhealthy to do so.

Slide 40 – Boom Lift Catapult Europe 2014 Video

## An Organized Approach

- An organized approach through a company Health and Safety Management System is necessary to ensure all roles, responsibilities, and program requirements are met or exceeded.

*The next sections of this course are based upon the key elements of a Health and Safety Management System.*

## Key Elements of a Health and Safety Program for MEWP Operators

- Training, Information and Auditing.
- Management, Supervision and Internal Responsibility.
- Job Planning and Hazard Assessments.
- Safe Operating Procedures.
- Prevention of Injuries.
- Equipment Maintenance and Modifications.
- Facility Design.
- Additional safety training may include First Aid, WHMIS, Transportation of Dangerous Goods, Spill Containment, Ground Disturbance, Fire Safety, etc.

Further requirements the employer must comply with

- Specifications and Certifications (for equipment).
- Chemical Hazards, Biological Hazards and Harmful Substances.
- General Safety Precautions i.e. securing equipment and materials.
- Lifting and Handling Loads.
- Mobile Elevating Work Platforms.
- Fork-mounted Work Platforms.

Training and Information

- Although it is the employers' responsibility for the provision of training, employees are responsible to use that knowledge and participate in any company procedures regarding the safe operation of their equipment.
- Remember, no one can make you a safe operator, that is a choice that you make every time you operate equipment.

Operators Basic Safety Practices

- Always use the operator restraint system.
- Operate the equipment from the operator's compartment only.
- Use the equipment for its intended purposes only.
- Obey safe operating policies.
- Maintain a clear path of travel.
- Travel in reverse if forward vision is blocked or use spotters if they are available.
- Notify your supervisor immediately if you are involved in an incident which results in personal injury or damage to the equipment.

## Emergency Actions

- An employer must establish an emergency plan for responding to emergencies at the workplace.
- The plan should be known and understood by all employees and trained so that they can react appropriately to the incident.

The Emergency Response Plan (ERP) should include:

- The identification of potential emergencies.
- Procedures for dealing with identified emergencies.
- The identification, location, and use of emergency equipment.
- The emergency response training requirements.
- The location and use of emergency facilities.
- The fire protection requirements.
- The alarm and emergency communication requirements.
- The first aid services required.
- Procedures for rescue and evacuation.
- The designated rescue and evacuation workers.

Training should also include understanding the procedures to follow in the event of an incident involving dangerous goods or controlled products.

The plan should also include the call-out details for the service engineer or other person who is competent.

- The emergency and rescue plan should identify trained, site-based personnel who would be available to lower the work platform using the control panel or emergency descent system situated at ground level.
- These people should be included in the familiarization training for the specific machines being used on site.

## Job Planning

- Every worker should attend daily crew meetings (i.e. tail-gate, toolbox) at the beginning of their shift.
- The purpose of the tail-gate meeting is to discuss and plan the work assignments for the day, and complete necessary documentation.
- It also allows workers an opportunity to ask questions regarding their assigned tasks.
- It is critical that all affected workers participate and contribute to the discussions at these planning sessions.

Taking the time to plan the job will save time and money, “Failing to plan is planning to fail”.

It is the worker’s responsibility to ensure that they have a clear understanding of assigned tasks including any hazards associated with the task.

Look at the ‘Big Picture’, discuss the over-all project and your role within it.

Note power lines, temporary roads, traffic patterns, pedestrian paths, material storage, equipment lay-down areas, and where other equipment is working.

Consider how your task may affect others, if others could be impacted by your assigned task discuss the issues with them and/or their foreman/supervisor.

What other vehicles, mobile plant or work equipment could be close by?

Look at where the other trades will be working later that day, week or month.

Decide where you will work, where you will pile, load and place materials.

Walk the jobsite; look for outbuildings, racks, and other obstructions that could interfere with your ability to operate safely.

Ensure that Alberta First Call has been notified and have marked underground services prior to disturbing the ground.

It is important to note that Alberta First Call doesn’t locate any private services that might have been installed by the property owner or the municipality, water shutoffs and such might need be located by a private utility locater service.

Determine what equipment, tools and materials your task will require, and select proper equipment, material and tools.

Ensure there are no conflicts with others’ tasks; if there are, alert your supervisor/foreman, so alternate arrangements can be made.

If transporting the equipment, determine whether a pilot vehicle(s) will be required and, if so, arrange for such.

## Operator's Manual

- MEWP operators must be familiar with the operator's manual for the specific equipment they operate.
- The information is vital for safe operation of the MEWP and outlines the equipment's safety concerns, safe operation and the equipment's maintenance requirements.
- Each piece of equipment must have an operator's manual available for it, if it doesn't then report this to your supervisor and order a new one.
- Read and follow the operators' manual.
- Observe all warning plates and decals on the equipment and in the operators' manual.
- The operator's manuals will explain any potential safety hazards whenever necessary in special messages that are identified with the word **DANGER**, **WARNING**, or **CAUTION**, and the safety alert symbol.

Memorize the meaning of the following boldface terms appearing in warnings in both the equipment manuals and on the equipment itself.



**Danger!** Indicates a high probability of death or serious injury and/or serious equipment damage if the hazard is not avoided.



**Warning!** Indicates a potentially dangerous situation that could cause injury or death and/or serious equipment damage if the hazard is not avoided.



**Caution!** Indicates hazards that could result in minor or moderate injury or damage to the equipment.

Refer to the operator's manual for the following information:

- Main components of MEWP.
- Basic specifications.
- Safety and security.
- Operator's cab.
- Operating the machine.
- Maintenance.

Genie Scissor Lift

<http://manuals.gogenielift.com/Operators/english/39527.pdf>

Genie Boom Lift

<http://manuals.gogenielift.com/Operators/english/32221.pdf>

Know your MEWP

- Read and understand the Operator's Manual before using the equipment; if the manual is not on the machine – get one!
- Read, understand and follow the Danger, Warning, Caution and other safety signs on your equipment.
- Know the rated capacity, speed range, braking and steering characteristics, turning radius, and operating clearances.
- Know the purpose of all the controls, gauges, and dials.
- Know where fire extinguishers, first-aid, and emergency equipment are kept and where to get help if needed.
- Know the weight of your loads and do not, at any time, exceed the rated capacity of the machine.
- Make sure your equipment is ready for the job it must do; ensure equipment has been examined, inspected, maintained and daily checks completed.

## Hazard Assessment

- OH&S Code Part 2 requires hazard assessments to be conducted to identify existing or potential hazards before work begins, at regular intervals and when anything changes that could affect the safety of the worksite.
- A report must be filled out listing the results of the hazard assessment and the methods used to control or eliminate the identified hazards.
- Equipment operators and supervisors must be involved in the hazard assessment process.
- Each job site has its own unique operating hazards and site considerations.
- Every equipment operator should take the time to assess every job site every time work begins for the day, shifts to a new location, or when a new job on the same site commences.
- Once a hazard has been identified, a worker is required to follow safe work procedures to avoid causing damage or injury at the worksite.
- Participate and Contribute to Discussions:
  - Ask questions of task assignment and how your job fits in with overall job.
  - Discuss your role with supervisor/foreman and co-workers.
  - Develop a work plan that accounts for others' tasks and reduces or eliminates risks to others that could be created by your task's hazards.
  - Assess and discuss specific task and/or site hazards; introduce new information as needed.

Consider the impact of worksite hazards such as:

- Slopes and inclines
- Ground conditions
- Moisture
- Soil stability
- Debris
- Loose gravel
- Vehicle and Pedestrian Traffic
- Other people and equipment working in the area
- Other PME
- Animals
- Fog or mist near lakes and ponds

Be alert for changes that may impact your task or those of your co-workers.; if any significant changes are noted, inform your co-workers.

## Check the Work Area

- Check the ground or floor over which you will travel and work. Look for obstructions, holes, debris, obstacles, drop offs or rough spots.
- Weak spots or covers on ramps and floors.
- Oil spills, wet spots, slippery surfaces, soft soil and standing water.
- Soft, uneven surfaces or anything that might make you lose control or cause you to tip over.
- Check the clearances overhead and of doorways and canopies. Also, check clearances when transporting your equipment on a truck or trailer.
- Know exactly how much clearance you have around electric power lines. Never move equipment closer than 3 m (10ft) plus twice the line insulator length to overhead wires.

## Assess weather conditions.

- If working outdoors, a detailed weather forecast should be accessed each morning. It is critical that weather is discussed during the planning sessions.
- Be prepared to adjust tasks, people and/or equipment if weather changes. If a weather change is expected, discuss the potential impact with the crew.
- Rain, snow, ice, etc., can change the operating characteristics and capabilities of your equipment and require extra caution during operation.



## Facility Design & Workplace Requirements

- Workplaces facilities must be designed to operate equipment safely.

The equipment operator should:

- Ensure there are adequate overhead clearances.
- Ensure that alleyways, and yards have adequate spacing to permit the safe operation of the equipment while engaged in work.
- Designated walkways, barriers, warning signs and other safeguards should be utilized to prevent the occurrence of a collision between a person and equipment.
- In the absence of designated walkways, safe work procedures must be in place for pedestrians walking near operating equipment.
- Watch for ponds that have steam rising obscuring visibility in the field.
- Be aware of wet conditions that could lead to uneven and soft ground.
- Ventilation must be adequate to remove toxic gases created using internal combustion engines while indoors.
- Workplace design should identify walkways for pedestrians and workers not engaged in equipment operation.
- Floors, aisles and passageways should be kept clear of debris and other potential hazards.
- Racks and other storage units should be of adequate strength to ensure they can safely store the intended loads.

## Safe Work Zone

- The creation of safe work zones for the equipment being used is an important aspect of keeping other workers and people safe.
- The safe work zone is typically calculated at 1.5 times the over-all length of the equipment extending completely around the furthest outside edge of the equipment.

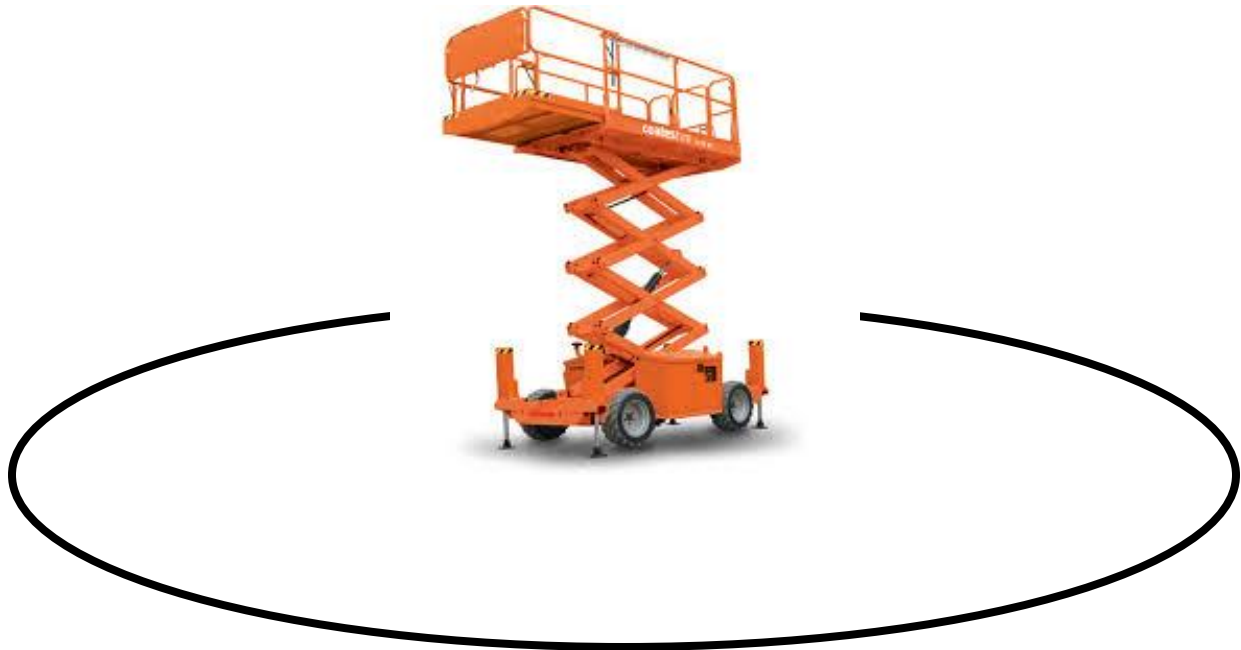

The above image represents the machines safe operating zone. This concept would be applied to any MEWP as a company policy.

## Chapter 2 Summary:

What was covered in Chapter 2?

- Employers' responsibilities as they relate to the operation of MEWP.
- Employees' responsibilities as they relate to the operation of MEWP.
- Key elements of a health and safety program for MEWP operators.
- Requirements of an Emergency Response Plan.
- Management, and supervision responsibilities as they relate to the operation of MEWP.
- Competency requirements as they relate to the operation of MEWP.
- Elements of proper job planning, and hazard assessment related to the operation of MEWP.

This Page Left Blank  
Intentionally

## **CHAPTER 3: INSPECTIONS AND MAINTENANCE**

### **Goal:**

The student will understand the importance of MEWP inspections and how to conduct the inspections safely.

### **Objectives:**

1. The student will be aware of the requirements of a visual inspection of MEWP and how to perform the inspection safely.
2. The student will be aware of the requirements of an operational inspection of MEWP and how to perform the inspection safely.
3. The student will be familiar with generic inspection checklist.
4. The student will be aware of actions to be taken when a defect on MEWP has been identified.
5. The student will be aware of the requirements in making modifications to MEWP.

## MEWP Inspection

The following are general guidelines to follow while completing an inspection.

- Inspections are usually part of a company policy; this ensures the employer that equipment is inspected on a regular basis.
- Equipment operators must ensure that their machine is in safe operating condition.
- Always follow the equipment manufacturer's inspection requirements. These inspections reveal necessary equipment repairs or replacements.
- Operators need to be able to recognize and record equipment problems and report unsafe equipment to the employer immediately.
- In addition to the equipment and attachments to be operated, inspections could also include damaged racking, dock-boards, loading ramps, straps, chains and cables and other equipment.
- The pre-operation inspection is a visual inspection performed by the operator prior to each work shift.
- The inspection is designed to discover if anything is apparently wrong with a machine before the operator performs the function tests.
- It is critical that a walk-around inspection be done to check for obvious mechanical problems, equipment clearances, closeness to other equipment or structures and other workers who may be at risk when the equipment is moved.
- If necessary, a MEWP operator may be required to perform pre, mid, and post operational inspections.
- The operator's manual outlines the frequency of inspections and maintenance for equipment.
- Be sure that the operator' safety and responsibilities manuals are complete, legible and in the storage-container located on the equipment.



**Danger!**

A worker should never operate equipment  
that is damaged and needing repair.

Inspections may include but are not limited to:

- Check the function of alarms, warning lights and other lights.
- Top up fluids, grease the machine, and keep it clean.
- Look around the machine for loose bolts, trash build up, oil or coolant leaks, and broken or worn parts.
- Inspect the condition of the attachments and the hydraulic components.
- It is not expected that the equipment operator performs mechanical duties such as changing oil, changing fan belts, or making repairs etc.

### Checklists

- Checklists must be based upon the requirements of the manufacturer; some equipment manuals include checklists that can be photocopied.

Checklists should be used by the operator to:

- Ensure that a proper inspection of their equipment is completed.
- Provide documentation that the inspection was completed as required.

### Key Elements of an Inspection Checklist:

- |                                                  |                                                             |
|--------------------------------------------------|-------------------------------------------------------------|
| • Date & time when the inspection was performed. | • Incidents that may affect the operation of the equipment. |
| • Repairs and modifications performed.           | • Number of hours operated.                                 |
| • Inspections performed.                         | • Certification records.                                    |
|                                                  | • Records the person doing the work.                        |



### **Warning!**

Do not walk underneath any suspended attachments unless they are mechanically supported and secure.

## Check List Example

On approach to the vehicle:

ITEM	DESCRIPTION	Yes	No
	Look around the equipment for obstructions, debris, other equipment and people.		
	Look for vehicle traffic and other equipment in the area.		
	Check that equipment is sitting level, on level ground.		
	Look for fluid underneath the machine and its attachments.		

At the vehicle, with the key in the “OFF” position, check for:

ITEM	DESCRIPTION	Yes	No
Exterior	Check body, safety guards for damage		
The equipment attachments and locking devices	Check condition, defective parts		
Mast or main lifting arm assembly	Check condition, defective parts		
Pins and bushings	Check condition		
Windows	Check cleanliness, wiper fluid level		
Mirrors	Check cleanliness and adjustment		
Tires	Check pressure and wear		
Wheel bolt studs	Check tightness		
Coolant	Check level		
Fuel	Check level		
Engine oil	Check level		
Air cleaner	Un-obstructed		
Seals	Leaks at oil, water and hydraulic lines		
Hydraulic cylinders, hoses and fluid	Leaks, and level		



Transmission fluid	Check level		
Battery	Check electrolyte level and terminals		
Air ventilation filter	Clean		
Fuel pre-filter	Drain water		
Air intake hoses	Check connections		
Fire Extinguisher	Present, secure, and charged		
First aid kit	Present, secure, and stocked		

With the key in the “ON” position, check for:

ITEM	DESCRIPTION	Yes	No
Instrument gauges	Functioning normally		
Operating, running, signal and emergency lights	Clean, operating and adjusted		
Warning devices and alarms	Good working order		

### Starting the Engine

Once you have performed all pre-operational procedures, you are ready to start the machine and test all functions. Before you start the engine:

- Look completely around the equipment before attempting start-up.
- Ensure all controls are in neutral.

With the machine running, check for:

ITEM	DESCRIPTION	Yes	No
Instrument Gauges	Warning alarms and lights are off		
RPM indicator and hour meter	Are working normally		
Fuel gauge	Level		
Drive forward and reverse	Working normally		
Steering	Working normally		
Service and park brake	Working normally		
Load handling devices	Working normally		
Odours, sounds, feel	Unusual or suspicious		
Safety interlock system	Working normally		
Foot pedal movement	Brake and throttle pedals are smooth		
<b>Comments</b>			
<b>Supervisor's receipt:</b>			
<b>Operator signature:</b>		<b>Date:</b>	
<b>Vehicle Identification:</b>		<b>Hour Meter:</b>	

PERIODIC MAINTENANCE SCHEDULE				
ITEM	EVERY 10 HOURS	DESCRIPTION	Yes	No
Check tire pressure and wear				
Drain water from air tank				
Inspect engine belts				
ITEM	EVERY 50 HOURS	DESCRIPTION	Yes	No
Fasten the connecting bolts on the front & rear drive shafts				
Check oil level in the brake booster pump				
Check and lubricate throttle control, parking brake and transmission control system				
Grease fan shaft, articulation points, drive shaft, and oscillating suspension				
<b>Comments</b>				
<b>Operator signature:</b>				
<b>Supervisor's receipt:</b>				

Ensure generic MEWP equipment checklists include the requirements of the equipment manufacturer.

## Inspection Deficiencies

If you find deficiencies while performing the operational inspection, determine whether the problem affects the safe operation of the equipment or not.

If the problem affects the safe operation of the equipment,

- Fit the machine with a “DO NOT OPERATE” tag. Follow company lock-out policy.
- Submit your operational inspection report to your supervisor for follow-up.

Otherwise, continue working but ensure the necessary repairs are carried out before the problem does have an effect on the safe operation of the equipment.

Many mechanical conditions or design features increase the risk for MEWP incidents, below is a list of the more common areas of concern.

- Malfunction of brakes.
- Malfunction of steering.
- Malfunction of clutch, shift linkage, or transmission.
- Emissions from equipment.
- "Blind spots" or obstructions blocking driver's view.
- Poor layout of controls and displays.

## Lock-out / Tag-out Procedures

- Lock-out / Tag-out procedures are used to ensure that any unsafe equipment is rendered inoperative until such time that it is repaired to the manufacturer's safe operation specifications.



### **Caution!**

Lock-out and tag-out unsafe equipment to prevent further use.  
Do not operate the machine until deficiencies are corrected and all systems are in good operational condition.

Lock-out of equipment may require multiple steps.



Battery Disconnect

Lock-out Master Control

Remove Key

Tag Out



## Equipment Integrity

- Operating capacities are determined by certified engineers on behalf of the equipment manufacturer.
- Due to the wear and tear that occurs to the equipment under normal operating conditions it is expected that, over time the equipment will deteriorate with use and therefore the equipment's capacity could decrease as well.
- Companies who follow the maintenance and service requirements of the equipment including Non-Destructive Testing can reasonably expect that the equipment will remain in good operating condition.
- This also gives the operator the confidence to operate the equipment to its capacity knowing that they have a reliable piece of equipment.
- It is the employer's responsibility to maintain equipment in accordance with the operator's manual.
- It is the operator's responsibility to inspect and help maintain the equipment they work with.
- If the equipment is not inspected and maintained according to the manufacturer's requirements as outlined in the operator's manual and an incident occurs, the liability may lay primarily with the employer, but also with the operator.

## Housekeeping

- Housekeeping is essential to preventing problems.
- The purpose of housekeeping is to keep the equipment clean and free of debris and loose objects that could cause problems.
- Before attempting to clean a machine, be sure to wear personal protection equipment as required, lower the platform and turn off the engine.
- Remember to blow down or wash the equipment regularly.
- It is the equipment operator's responsibility to ensure that the equipment they are operating is cleaned and ready for the next operator and/or next shift.
- Clean steps, railings, ladders, and floor.
- Remove grease or oil. Brush away dust or mud. In the winter, scrape away snow and ice.
- Replace slip-resistant tape or paint, as required.
- Keep the cab clean & free of loose objects and debris.
- Remove or put away tools, ropes, and hooks. Remember-loose items on the floor could cause an accident.
- Maintain the fire suppression system.

## Maintenance

- Regular equipment maintenance is an essential element of any safety program.
- Only routine maintenance items specified in the manufacturer's manual may be performed by the operator.
- Repairs to the equipment must be made by a qualified service technician, according to the manufacturer's specifications.
- After repairs are completed, the operator must perform a pre-operation inspection again before going on to the function tests.

## Modifications

- An employer must ensure that any modification, welding, or cutting of a rollover protective structure or a falling object protective structure is done in accordance with the manufacturer's instructions and is re-certified as restored to its original performance requirements by, the equipment manufacturer or a professional engineer.

## Chapter 3 Summary

### What was Covered in Chapter 3?

- Requirements of a visual inspection of MEWP and how to perform the inspection safely.
- Requirements of an operational inspection of MEWP and how to perform the inspection safely.
- Importance of using checklists when performing inspections.
- The actions to be taken when a defect on MEWP has been identified.
- Requirements for making modifications to MEWP.



## **CHAPTER 4: SAFE OPERATION OF MEWP**

### Goal:

The student will be familiar with the requirements for the safe operation of MEWP.

### Objectives:

1. The student will be familiar with General Operation procedures for MEWP.
2. The student will be aware of the importance of being proficient with specific safe operation procedures of the MEWP they operate.
3. The student will be aware of the importance of mounting and dismounting equipment in a safe manner and using appropriate Personal Protective Equipment (PPE).
4. The student will be aware of the importance of following proper start-up and shutdown procedures for MEWP.
5. The student will be familiar with communications procedures while operating MEWP.
6. The student will be familiar with essential qualities and rules for MEWP operators.
7. The student will be familiar with procedures for the safe movement of MEWP.
8. The student will be aware of conditions that can affect the safe operation of MEWP.
9. The student will be aware of special hazards related to MEWP.
10. The student will be aware of procedures for the safe transportation of MEWP.

## OHS Code Part 19 – Powered Mobile Equipment

This is a major component of this course. The course will touch on all sections of Part 19 relative to Mobile Elevating Work Platforms. Many of these regulations reference standards that must be met.

Follow this link and familiarize yourself with those sections of Part 19 that we have already discussed as well as Sections 264 thru 280.

<http://www.qp.alberta.ca/documents/OHS/OHSCode.pdf>

### General Operation

- Never operate equipment that is not working properly. If a malfunction occurs, shut it down.
- Never slam a control switch or lever through neutral to an opposite position.
- Always return switch to neutral and stop before moving the switch to the next function.
- Operate controls with slow and even pressure.
- Hydraulic cylinders, other than the outrigger cylinders, should never be left at end of travel (fully extended or fully retracted) before shutdown or for long periods of time.
- Always 'bump' control in opposite direction slightly when function reaches end of travel, this applies to both equipment in operation and in the stowed position.
- Never use the equipment to push or pull another vehicle except as approved by the manufacturer.

### Machine Specific Safe Operation

- The Equipment Operator's Manual contains instructions for the model of equipment that you will be operating.
- It is important that you take the time to read the manual and understand the controls and functions of the specific machine that you will be operating.
- It is the operator's responsibility to follow all the safety rules and instructions in the operator's manual.

Using the equipment for anything other than what it was intended to do is unsafe and dangerous.

**The operator's manual should always be consulted  
prior to starting the equipment.**

## Basic Safety Rules

- The only safe place to operate equipment is from the operator's station.
- Take care climbing into/onto the equipment. Squarely face the vehicle and use the three-point contact method for mounting and dismounting; two feet and a hand or two hands and one foot.
- Never use equipment controls as handholds when mounting or dismounting. Because of the play in the levers, you could lose your balance and slip or cause the equipment to move.
- Observe proper shutdown practices before dismounting.
- Never dismount from a moving machine.
- Before dismounting the equipment, make sure the nested position, the vehicle is in neutral, and the parking brake is on.
- Be sure hands and feet are free of excess debris, grease and oil.
- Use extra care when mud, snow, or moisture present slippery conditions.
- Keep steps clean and free of grease and oil.
- Use handrails, ladders or steps (as provided) when mounting the machine.
- Never step on foot controls when mounting or climbing off.
- Dismount carefully using three-point contact and face the machine.
- Check for slippery steps.
- Keep your feet and hands away from the controls.
- Never jump off the machine.

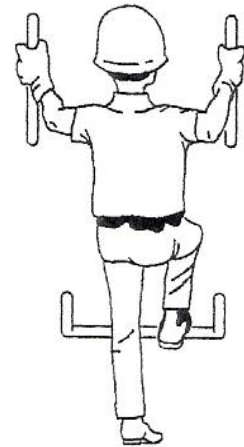

## Fall Protection

Alberta OH&S Regulation Part 9 Section 156 (1-2) requires that a travel restraint system be used on elevating work platforms in Alberta workplaces.

An employer must ensure that a worker on a boom-supported elevating work platform, boom-supported aerial device, or forklift truck work platform uses a personal fall arrest system connected to an anchor specified by the manufacturer of the work platform or aerial device.

When connected to the anchor, the lanyard, is short enough to prevent the worker from being ejected from the work platform or aerial device but is long enough to allow the worker to perform his or her work.

An employer must ensure that a worker on a scissor lift or on an elevating work platform with similar characteristics uses a travel restraint system consisting of a full body harness and lanyard connected to an anchor specified by the manufacturer of the scissor lift or elevating work platform.

When connected to the anchor, the lanyard, if reasonably practicable, is short enough to prevent the worker from falling out of the scissor lift or elevating work platform but is long enough to allow the worker to perform his or her work.



Section 156(4) also states that if a worker's movement cannot be adequately restricted in all directions by the travel restraint system, the employer must ensure that the worker uses a personal fall arrest system.

- While in a lift workers must have fall protection in place, including a full body harness, lanyard and appropriate anchor point.
- The lanyard must be short enough to prevent the worker from being ejected or from falling out of the work platform or lift.

## Fall Restraint Anchors

- All boom style machines are equipped with anchors.
- Some scissor lifts may have anchors, and some may not.
- The purpose of the anchor is for the operator to attach their fall restraint system to.
- If the operator is not attached to the anchor in a boom style machine the operator could be catapulted out of the platform and suffer severe injury.
- Anchors are not designed to have more than one person attached at a time.
- The guard rail on an elevated work platform must not be used as an anchor point.
- Never anchor to an object outside of the platform.

## Lifts without Anchor Points

- Some older scissor lifts were manufactured without anchor points. The manufacturers instructions for use must state that the scissor lift's guardrails as a means of fall protection is acceptable.
- The operator's manual must be with the scissor lift.
- The scissor lift must be operating on a firm, substantially level surface.
- Guardrails and railings are not anchor points.

## Basic Operating Procedures

- Starting - Before starting, walk completely around the equipment, make sure no one is under it, on it or close to it.
- Follow the starting procedures recommended by the manufacturer of your equipment. Check all instruments, gauges and indicator lights.
- Check for instructions in the operator's manual for cold weather starting.
- **WARNING:** Starting fluids are highly flammable.
- Ensure you can control machine functions, speed and direction before moving.
- Should something break, loosen or malfunction on your machine, stop work, shut off the engine and seek qualified assistance to correct the condition.
- Do not operate the machine until the condition has been corrected by authorized personnel.
- **WARNING:** Exhaust fumes can kill.

### Additional Information:

Let other workers and bystanders know you are starting up and don't start until everyone is clear of the machine.

Follow the manufacturer's instructions for use of starting fluids, don't carry loose cans of starting fluid in the machine.

When starting your equipment in an enclosed space, make sure there is enough ventilation.

Do not start or drive the equipment into confined areas such as refineries where flammable gases may be present.

Check with plant safety personnel before entering any questionable area.

After starting, recheck all gauges and lights.

Check the audible and/or visual alarms (if provided).

If the equipment does not respond correctly when each control is operated, do not use the machine until it is fixed.

Move slowly until you are certain everything is operating properly.

Recheck the steering, right and left.

Be certain you have full travel and automatic brake control.

Be certain you can raise and lower the platform.

Safe shutdown procedures - Correct shutdown is important to safe operation, refer to your manufacturer's manuals.

## Generic Steps:

### Park Safely

When parking or leaving the equipment for any reason,

Park your machine in a designated area or out-of-traffic and only on level ground.

Come to a full stop.

Place and lock controls in neutral.

Engage the parking brake.

Lower or secure the platform.

Idle engine for gradual cooling.

Block the wheels.

Shut off engine or electrical power.

Take necessary steps to prevent unauthorized use in accordance with the operator's manual.

## Communications

- Companies are required to have a policy regarding communication amongst workers on the job site.
- The communication system can include the use of radios, hand signals, lighting signals, audible signals, and so on.
- In some cases, companies use spotters to guide equipment operators.
- It is the operators' responsibility to ensure effective communication protocols are in place for all workers near operating equipment.
- A communication system must be developed and understood where spotters/signalers are used.
- Radio communication and hand signals must be discussed and fully understood amongst all workers that will be utilizing them.
- Always keep signal person in view

Generic Hand Signals:

## PROCEED SLOWLY

### FORWARD



Always face palms in direction of desired travel.

### BACKWARD



Then bend both arms repeatedly toward head and chest, and then extend.

## ← TURNS →



Point one arm to indicate the direction to turn.



Bend monitoring arm repeatedly toward head to indicate continued turning.

## DISTANCE TO STOPPING POINT



Face palms forward, with hands above head. Bring elbows forward and hands together.

## STOP

Cross both arms above head.





# Moving the Attachment



**Extend Boom**



**Retract Boom**



**Swing**



**D&G (Stop) Everything**



**Raise Boom**



**Lower Boom**



**Hoist**



**Lower**



**Stop**



**Move Slowly  
(eg. Hoist Slowly)**

## Essential Qualities of an Equipment Operator

### **Knowledge**

- Federal and Provincial legislation, company rules and safe operating procedures.
- Principles of operation, features, selection and limitations of the equipment.
- Workplace conditions and environment, and activities that pose a danger to worker health and safety.
- Emergency procedures.
- The equipment's specifications.
- Momentum, leverage, and stability principles, and capacity as well as the forces affecting the equipment and its stability.

### **Skills**

- Operating experience and knowledge of the equipment they operate.
- Good decision-making ability when judging operating conditions.
- The proper selection, security and integrity of various.
- Proper and safe refueling and recharging practices.

### **Good Attitude**

- A safety-first philosophy.
- No need to prove himself or to show off.
- Not being pushed beyond safe limits by production schedules or peers.
- Exercising self-control.
- Being cooperative, courteous and considerate of others.

### **Physical Qualities**

- Good reflexes and coordination.
- Good vision and depth perception.
- Good physical conditioning.
- Quick thinking.

## Rules for Equipment Operators

- Know the equipment's lifting capacities and never exceed them.
- Never allow anyone to walk or stand under an elevated platform.
- An operator must not leave the controls of the equipment unattended unless it is secured against unintentional movement.
- Operate only on solid footing with strength sufficient to support the machine, be especially alert working near embankments, excavations and on slopes.
- Never drive your equipment up to someone standing in front of a fixed object.
- Limit the height of the platform as much as possible while travelling, especially on side slopes or an unstable surface.

New employees must receive an orientation on the specific equipment at the workplace and be trained or evaluated on the specific equipment prior to operating it.

- Always operate the equipment in a safe and courteous manner with absolutely no stunt driving or horseplay.
- Ensure there are adequate clearances for the work in progress.
- Workers must operate the equipment safely, which includes watching for moving parts that may endanger a worker.
- Prepare the work site properly, avoid operating near structures or objects that could fall onto the equipment.
- Avoid working under over-hanging embankments or stockpiles that could collapse under or on the equipment.
- Make certain everyone is clear of the machine before you begin lowering a platform.
- Maintain a clear path of travel.
- Avoid sudden stops, starts, turns or changes in direction.
- Never alter, remove or substitute any item which could reduce the overall weight or base stability of your machine; such as counterweights, foam filled tires, batteries, etc. unless authorized by the manufacturer.

## Special Hazards:

- Battery Hazards

Charge batteries only in a well-ventilated area.

Refer to manufacturer's manuals for charging procedure.

Warning Lead-acid batteries produce flammable and explosive gases.

Never allow smoking, flames or sparks around batteries.

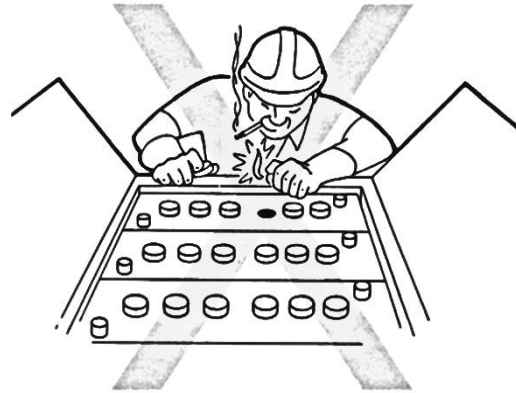

- Crossing Railway Tracks

Watch for railroad traffic anytime you are working on or near tracks.

Use regular track crossings whenever possible or risk damaging the tracks.

Ensure permission to cross tracks has been given by track operator.

Greasy or slippery tires can make travel over tracks more difficult.

Tracks may cut tires.

Never park closer than 8 feet to center of railway tracks.

- Ground Obstructions

Always watch for ground obstructions that affect vehicle stability.

## Hydraulic Oil Injection Injury

Hydraulic injection injury is the term used to describe an injury sustained by an individual following an injection of fluid, usually while operating or inspecting pressurized hydraulic equipment.

Pressurized fluid such as those found in hydraulic application can travel at the speed of a bullet and penetrate all known levels of PPE.

Skin penetration can occur at pressures as low as 100psi and from 4 inches to the source.

### Prevention

Maintain 12" distance from sources.

Use a barrier.

Ensure all hoses are protected from chafing.

Inspect components on routine basis.

Replace (never repair) worn hoses or components.

Wear all recommended PPE when working with on or around hydraulic systems or components.

### Treatment

Hydraulic oil injection injuries can be fatal, seek medical attention immediately.

- **Mud and Wet Conditions**

Wet conditions cause sideways slippage of the machine on any slope.

Consider chaining the wheels – front and back.

Feather the controls; avoid sudden starts and stops as machine will slide.

Keep wheels cleaned. Mud will build up inside wheels and then harden around valve stems causing the valve stems to break or become unseated.

Keep inside of tracks clean. Excess material will cause excess wear and tear, or possible cause a track to slip off.

- Overhead Power Lines (OHPL)

Accidental contact with live overhead power lines kills people and causes many serious injuries every year.

People are also harmed when a person or object gets too close to a line

As required by section 8 of the OHS Code, the employer is responsible for making workers aware of the hazards associated with work near energized OHPL.

Workers must follow the employer’s directions to maintain the appropriate safe clearance distance.

**Safe limit approach distances for persons and equipment**

Operating voltage between conductors of overhead power line	Safe limit of approach distance for persons and equipment
0-750 volts Insulated or polyethylene covered conductors (1)	300 millimetres
0-750 volts Bare, uninsulated	1.0 metre
Above 750 volts Insulated conductors (1) (2)	1.0 metre
750 volts-40 kilovolts	3.0 metres
69 kilovolts, 72 kilovolts	3.5 metres
138 kilovolts, 144 kilovolts	4.0 metres
230 kilovolts, 260 kilovolts	5.0 metres
500 kilovolts	7.0 metres

An employer must contact the power line operator before work is done or equipment is operated within 7.0 metres of an energized overhead power line to determine the voltage of the power line, and to establish the appropriate safe limit of approach distances.

Slide 139 – Overhead Power Line Incident Video

An employer must ensure that the safe limit of approach distance is maintained and that no work is done, and no equipment is operated at distances less than the established safe limit of approach distances.

An employer must notify the operator of an energized overhead power line before work is done or equipment is operated in the vicinity of the power line at distances less than the safe limit of approach distances and obtain the operator's assistance in protecting workers involved.

An employer must ensure that earth or other materials are not placed under or beside an overhead power line if doing so reduces the safe clearance to less than the safe limit of approach distances.

Safe limit approach distances vary from one jurisdiction to another, it is the employers' responsibility to verify the requirements of the jurisdiction within which they are operating.

Some employers exceed the required safe approach distances as an extra safety measure.

- Pedestrian Traffic

- Give pedestrians the right of way.

- Never allow pedestrians to enter the work area.

- Signal pedestrians to stop when in the middle of a job.

- Pedestrians often take short cuts and back-up alarms are sometimes ignored.

- When passing pedestrians, sound horn, establish eye contact and stay clear.

- Wave them on only when it is safe for them to pass.

- If a pedestrian does enter the immediate work area, lower your platform to the ground and stop operating.

- If the pedestrian gets too close to your machine, shut it off and remove residual energy from hydraulic system.

- Use a signal person if moving equipment in congested areas or where visibility is restricted.

- Slow down and sound horn at blind corners when working in the yard and maintenance areas.

- Check convex mirrors placed at blind corners if available.

- Follow normal traffic patterns.

- Re-Fueling Safety

OHS Code Part 19, Section 279 Refuelling

No Ignition sources within 7.5 metres

Do not overfill

Turn off all equipment before refuelling.

Lower the platform to the ground to provide an electrical ground in case of accidental sparking.

Don't refuel while another machine is starting or running in the area.

Wear PPE.

Locate firefighting equipment at the re-fueling station. Follow company emergency procedures in the event of a fire.

Review location of manual shutoff valves and switches and all emergency shutdown procedures.

Use correct type and grade of fuel.

Notify proper personnel and follow company requirements in the event of a spill.

**DO NOT SMOKE!**

- Rough Terrain

Go slow – save the machine. It will rattle the machine and break components.

Carry less material.

If possible, smooth out rough terrain in the area that you will be operating in.

- Speeding

Never speed with the machine.

High range should only be used when “roading” the vehicle.

Keep a safe distance between you and other machines.

Always keep your machine under control.

Operator control is reduced significantly at high speeds.

Hitting an object at high speed could cause loss of steering and control, and significant injury to the operator and damage to the equipment.



- Time pressures.

Both supervisors and customers will pressure the operator. You are in control, slow and steady usually wins the race.

Carry the platform “Low and Slow”. Keep the center of gravity of the equipment as low as possible.
- Understand your travel paths.

Reverse, forward, obstructions, clearances, ruts, bumps, and traffic patterns should all be given consideration.

Fill in ruts.

Pad concrete curbs and sidewalks with soil. This will save on tires and the equipment operators back.

Build ramps over finished work, temporary lines and pipes.
- Working at Night.

Walk around the machine more often.

At night, it is more difficult to see fluid leaks.

Look for loose parts, leaking components and damage.

Walk the jobsite.

The area will look different when working under artificial light.

Dust will cause more visibility issues at night under artificial light.

Look for dips, drop-offs, and marked utilities.

Clear away trash and debris pick up anything that might puncture a tire. Make sure aisles, ramps, doorways and passages are clear.

## Transporting the Equipment Safely.

- If your equipment is to be transported by trailer or towing, refer to the manufacturer's manual for the procedures to prepare or load the equipment for transport.
- Back onto trailer only after ensuring that the trailer is properly connected to tow vehicle.
- Back onto the trailer and drive forward off it.
- Cap exhaust stack.

"Trailing" must be considered a potentially very hazardous operation.

Note: The machine shipping weight that is listed is the weight of the most common configuration of the machine. If attachments have been installed on your machine, the weight of your machine and the center of gravity of your machine may vary.

Reference: Refer to Operation and Maintenance Manual, "Specifications" for the dimensions and weight of the machine.

When transporting the equipment on a truck or a trailer, the prudent operator must know the overall height of transport vehicle with the equipment on board to avoid contacting overhead obstructions such as bridges, underpasses, electrical power lines and such.

The operator of a truck & trailer combination has care and control of 2 vehicles, the tow vehicle and the trailer.

The trailer presents a far greater potential hazard than the tow vehicle for 2 reasons:

The trailer can present a very large mass to the world by its cargo capacity.

The trailer is un-powered; it is controlled through the movement of the tow vehicle.

The connection between tow vehicle and trailer and, therefore, the control of the trailer by the operator, is completely dependent upon the hitch mechanisms.

Failure of this connection presents enormous potential risk of injury or damage to the public, the environment, and of course, the tow vehicle driver.

Slide 142 – Trailing Incident Video

#### Considerations for trailering equipment:

Ensure truck and trailer is registered for the combined weight and can haul the equipment.

Place trailer on firm flat surface.

Block the tires on both the truck and trailer.

Ensure that the trailer is blocked underneath to prevent it from lifting at the front when the machine is driven onto it.

Check truck and ramp capacities and grade of any expected inclines.

Use spotter.

Position machine so that the weight is slightly ahead of and over top of axles.

Properly nest and secure the boom and platform.

Set park brake.

Shut off machine.

#### After it has cooled down:

Use proper tie down procedures.

Securely chain all four corners.

Tie down as per the manufacturer's instructions.

Use only inspected chain and angle it slightly away from machine.

Tie boomer handles down.

Know overall height, weight and width.

## Lifting and Tie Down Points for the equipment

Improper lifting or tie-downs can allow the load to shift and cause injury or damage. Install the steering frame lock link before lifting.



Lifting Point - To lift the machine, attach the lifting devices to the lifting points.



Tie Down Point - To tie down the machine, attach the tie-downs to the tie down points.

Use properly rated cables and properly rated slings to lift the machine.



## Operator Safety

- People have been injured while operating their equipment with body parts outside the basket.
- Keep all loose clothing and machine parts away from pinch points.
- Keep extremities inside the protective screens.
- Never reach outside of the basket.
- Never operate basket controls from outside the basket.

## Chapter 4 Summary:

### What was Covered in Chapter 4?

- General Operation procedures for MEWP.
- Importance of being proficient with specific safe operation procedures of the MEWP they operate.
- Mounting and dismounting equipment in a safe manner and using appropriate Personal Protective Equipment (PPE).
- Importance of following proper start-up and shutdown procedures for MEWP.
- Essential qualities and rules for MEWP operators.
- Communications procedures while operating MEWP.
- Procedures for the safe movement and re-fueling of MEWP.
- Special hazards and conditions that can affect the safe operation of MEWP.
- Procedures for the safe transportation of MEWP.

## **CHAPTER 5: BASIC OPERATION OF MOBILE ELEVATING WORK PLATFORMS**

- The purpose of this section is to introduce some of the more common types of Mobile Elevating Work Platforms and have the operator understand the basics of the equipment including the equipment's drive, steering modes and turning dynamics, its strike points, its stability shape and centres of gravity.

### Goal:

The student will be familiar with different types of MEWP, their basic structural components, basic function, potential hazards while operating MEWP and how to control those hazards.

### Objectives:

1. The student will be aware of common types of MEWP.
2. The student will be familiar with the basic structural components of MEWP and how they function.
3. The student will be aware of potential hazards while operating MEWP and how to control those hazards.
4. The student will have basic knowledge of operating MEWP.

- Under Alberta’s Occupational Health and Safety Code “Powered Mobile Equipment” means “a self-propelled machine or combination of machines including a prime mover or a motor vehicle, designed to manipulate or move material or to provide a powered aerial device for workers”.
- Some Mobile Elevating Work Platforms are “Powered Mobile Equipment”.
- Manufacturers design the equipment to withstand the forces involved with having to perform their duty.
- The MEWP operator needs to understand the limitations for which the machine will operate under.
- They are designed for an intended purpose and have associated hazards.

There are many manufacturers of equipment with many styles and shapes.

It is most important for equipment operators to understand the terrain and the operating conditions for which their machine is intended to operate under.

Due to the nature of work being performed using the equipment, associated hazards to the operator as well as those workers working in proximity to the machine exist.

Operators must understand the responsibility they have while operating equipment.

The weight combined with the lack of training that so many operators have, contribute to become one of the most dangerous operations found in workplaces today.

### CSA Classifications of Mobile Elevating Work Platforms

The Standards organizations (CSA, ANSI and others) have categorized Elevating Work Platforms into two groups and three types.

#### MEWP Groups:

Group A – the MEWP moves vertically but within the tipping lines

(i.e. Scissor Lifts).

Group B – the MEWP can move beyond the tipping lines (outriggers or wheels)

(i.e. boom lift).

#### MEWP Types:

Type 1 – the MEWP can only be driven with the platform in the stowed position

Type 2 – the MEWP can be driven elevated but is controlled from the chassis

Type 3 – the equipment can be driven elevated, controlled from the work platform.

## CSA Classifications of Mobile Elevating Work Platforms

### Mobile Elevating Work Platforms Group A (must be within tipping lines)



Type 1  
(must be stowed to move)



Type 2  
(controlled from chassis)



Type 3  
(controlled from platform)

### Mobile Elevating Work Platforms Group B (can move beyond tipping lines)



Type 1  
(must be stowed to move)



Type 2  
(controlled from chassis)



Type 3  
(controlled from platform)



## Boom Scissor Components

- Boom and scissor components are the mechanical devices that are attached between the platform and the chassis or turntable that lifts and lowers the platform.
- Straight stick booms components consist of the main boom with up to three additional booms that telescope and retract within each other.
- Articulating booms can have two booms which consist of the main boom and a secondary/riser boom that can telescope or retract.
- Scissor lift components are linked together; the lift height will determine the amount of links.

Each unit will have their own range of motion that the operator must be aware of.

Riser booms have a specific sequence of operation and if not operating properly this may make the unit unstable. Refer to the operator's manual for proper operation.

## Jib Boom

- The Jib Boom gives the operator a greater range of motion for easier access to their work location.
- The hazards with a jib boom are due to the manoeuvrability of the jib; the operator can become entangled in tight spaces very easily.
- Always look in the direction that you are moving the platform and watch for any crushing hazards.

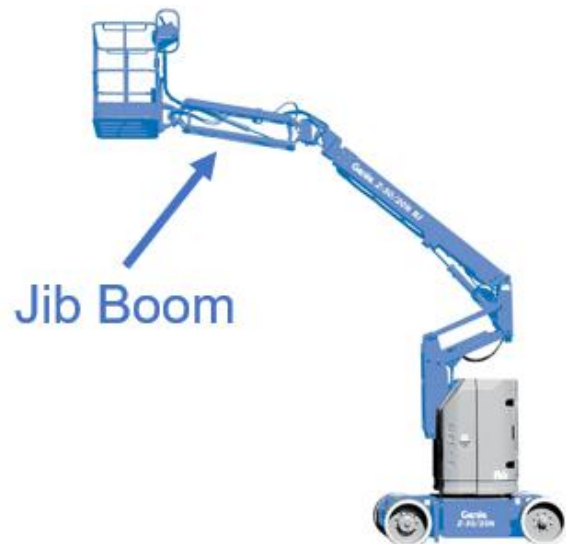

The jib is an extension from the primary/main boom that can be adjusted hydraulically.

The purpose of the jib boom is to help the worker manoeuvre into position easier.

This system has up 144 degrees of motion horizontally and some may have 180 degrees of side to side motion.

The jib boom is approximately 6 feet or 2 meters in length.

## Extendable Axles

- Extending the axle increases the stability area for elevated work platforms.
- The axle must be extended outward to the fully extended position before the safety interlocks will allow the boom to be raised or extended.
- If the axles are not extended and the machine allows the boom to elevate or extend then the unit must be removed from service and repaired; a limit switch may be damaged.



The ability to position the boom at an elevated height without the axles extended could cause the unit to overturn resulting in serious injury or fatality.

Extendable axles are a box in a box design that can be stretched to-full width using a hydraulic system.

The axle will extend outwards by use of hydraulics to the determined width.

Older models can be extended while using a jacking system, but all the new machines are drive and set.

Jacking systems are a device for lifting the wheels off the ground so that the axles can be extended.

They are used on the larger units and are hydraulically activated.

During the pre-use/pre-operational inspection look for any hydraulic leaks and confirm proper operation.

Remember, if the extendable axles are set out, they can stay set for the entire project.

The main hazard to be aware of with the jacking system is that the surface that you are working on can take the weight you are lifting.

Ensure all wear pads are in place and in working condition.

This system will be found on all of the larger units that can extend beyond 80 feet (24.38 meters).

## Emergency Controls

- If the primary system fails, the emergency controls are designed to lower the platform to the stowed position.
- If the emergency controls are not functioning properly then the system may not work properly when needed.
- Always have ground personnel nearby that are trained on the emergency controls.

## Tilt Alarms

- Tilt alarm systems are mandatory on all MEWP's and have a predetermined setting from the factory.
- The tilt alarm warns the worker that the unit is on a severe slope, DO NOT elevate until repositioned to a level surface.
- Test the tilt alarm during the pre-use/pre-operation inspection. Refer to the operator's manual for the specific unit to be operated.
- Some units have interlocks that stop the unit from lifting when the tilt alarm sounds.

## Limit Switches

A limit switch is a device for breaking connection in the electrical circuit so that the machine will not work past safe limits of operation, they are installed to limit boom position, elevated drive speed, axle position or steering position and work to keep the unit operating within each component's safe parameter.

- Always confirm limit switches are operating properly during the pre-use inspection.
- Most limit switches are inaccessible so always consult the operator's manual for proper testing procedures.
- If a limit switch is not functioning properly the MEWP could operate out of sequence, this is extremely dangerous.

## Basket/Platform

- Operation of the controls must be performed while the operator is within the confines of the basket.
- Because crushing injuries is the most common hazard while operating an MEWP many platforms have pinch protection to protect the operator.
- The railings also act to protect the operator from injury during operation.

The platform has a top rail, mid rail, and toe kick enclosure designed to keep the operator on the platform while protecting workers below from having tools and equipment dropped onto them.

- Do not overload the machine.
- Use travel restraint and connect to approved anchor points.
- Ensure the gate closes and latches.
- Do not operate if any safety interlock device malfunctions.



## Drive

- MEWP is driven through an engine or motor and transmission.
- Four-wheel or all-wheel drive is used for working in rough terrain at lower speed.
- Two-wheel (front) drive is used at higher speeds when traveling on public roads.
- Some equipment uses low and high range.
- If the equipment is of the wheeled type intended for rough terrain, it will usually operate in a low range gear with low speed using four, or all-wheel drive.

Some are hydrostatically driven.

If ever the equipment needs to travel some distance between one work location and another, many machines can shift into a higher range gear for higher speeds that involves 2-wheel drive operating at higher speed.

When equipment is traveling in 2-wheel drive, typically the front wheels provide the drive as the rear axle is disengaged while in 2-wheel drive.

Wheels, other than drive wheels, would include load bearing wheels; including “tag axle” wheels, castor wheels, steering wheels, or a combination of drive and steer wheels.

## Tires and Tracks

- If the equipment is designed to operate in rough terrain, it will usually have tires or tracks appropriate for the terrain.
- Just because a tire has good tread does not necessarily mean the machine was intended to be operated in rough terrain; it could simply mean it was intended to operate outdoors.
- The tires and tracks used on MEWP are an indicator of where it is intended to operate.

## Tires

- Tires used in rough terrain will have an aggressive tread.
- Tires intended for smooth terrain will have light tread or smooth “slicks” tires.
- Tires could be filled with air or nitrogen, filled with foam or liquid ballast, or completely solid.

Rough terrain tires are the standard tires used on equipment intended to operate in rough terrain.

These tires have an aggressive tread intended to help climb and descend slopes; however, they are not as aggressive a tread used for side slope.

MEWP driven on tires in rough terrain tend to concentrate the weight of the vehicle over smaller areas and therefore provide the risk of sinking or bogging down in soft terrain.

Solid tires are known as cushion tires even though they feel very rough because they are solid; however, while under load cushion tires become quite soft.



These “slicks” provide for a smoother, quieter ride with less vibration placed upon the machine and operator than those with tread, especially when used indoors.

## Tracks

- Tracks are especially useful in rough terrain where slopes and inclines are present.
- Tracks are also useful in soft terrain; they spread the weight of the machine out over a much larger surface area providing the benefit of “floating”.
- Steel tracks are used exclusively for rough terrain.
- Rubber tracks can be used in rough terrain as well as on concrete, asphalt or other similar surface without the risk of tearing up those surfaces like a steel track would.
- Equipment driven on tracks could be of either steel or steel with rubber pads.

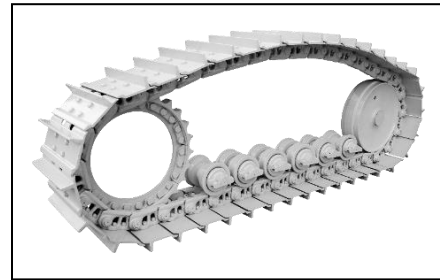

- Tracks are very aggressive while ascending and descending inclines but are significantly less aggressive on side slopes.

## Steering and Turning Dynamics

- All MEWP have a means of steering and turning side to side using pivot points on which they turn.
- Operators must understand the pivot points of the equipment they're operating because the vehicles pivot points are what the operator should use to judge where and when to turn the vehicle to avoid hitting obstructions and clearing the corner they're turning.
- Equipment driven on wheels may have front wheel steer, rear wheel steer, all wheel steer, crab-style steer, skid style steering and articulating steering.

Equipment that has either all wheel steer or articulating steering uses a much smaller turning radius that allows the operator to turn within tighter corners and is often used on uneven ground where traction is limited.

Some machines can turn in a zero-radius circle.

Crab steering is used to turn all wheels in the same direction, which allows for lateral movement with no change to the longitudinal alignment of the boom.

Front wheel steer typically has the largest turning radius of all the steering types.



## Pivot Points

- Equipment using the front wheels to steer, use the rear wheel as pivot points; and for equipment that using the rear wheels to steer, use the front wheels as the pivot.
- Remember, because the pivot point is not the steering point; use the steering wheels to direct the pivot wheels.
- The pivot point is reversed when the vehicle is reversed.
- If the equipment has multiple axles, the centre of the axles acts as the pivot point.
- For VRLT's that uses crab-style steering, it's the centre at the front and rear of the vehicle that acts as the pivot points.

If we look at an overhead view of several pieces of equipment, we can see the location of the pivot points the equipment uses to turn a corner with.

The operator needs to understand the equipment's turning dynamics and pivot points and be constantly aware of these things to avoid striking something.

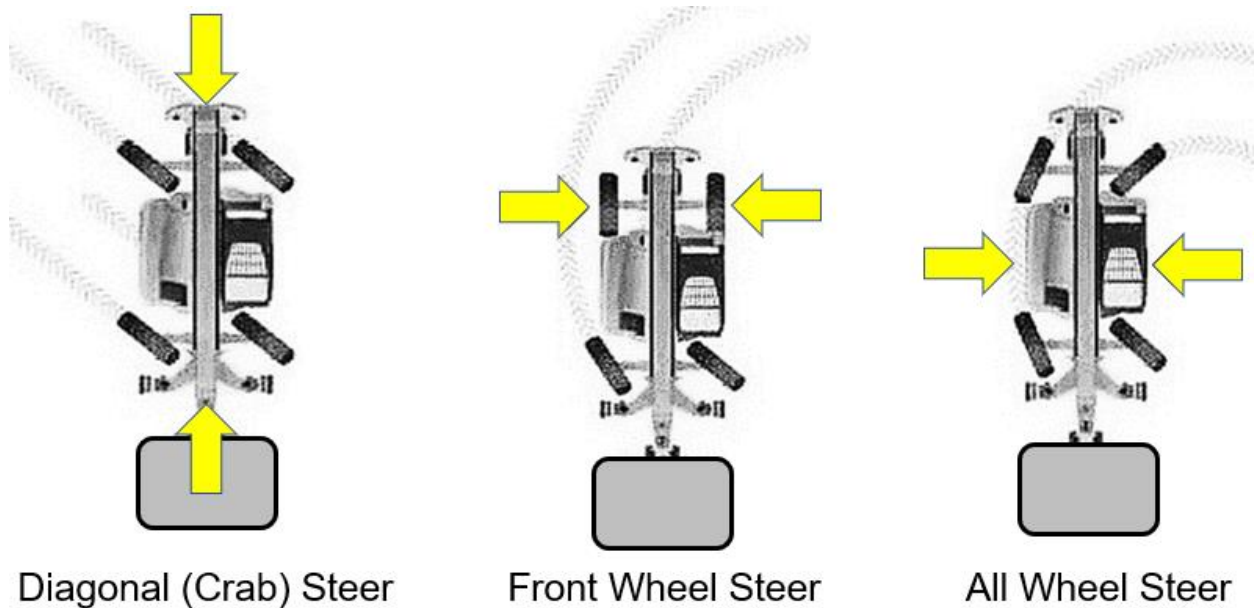

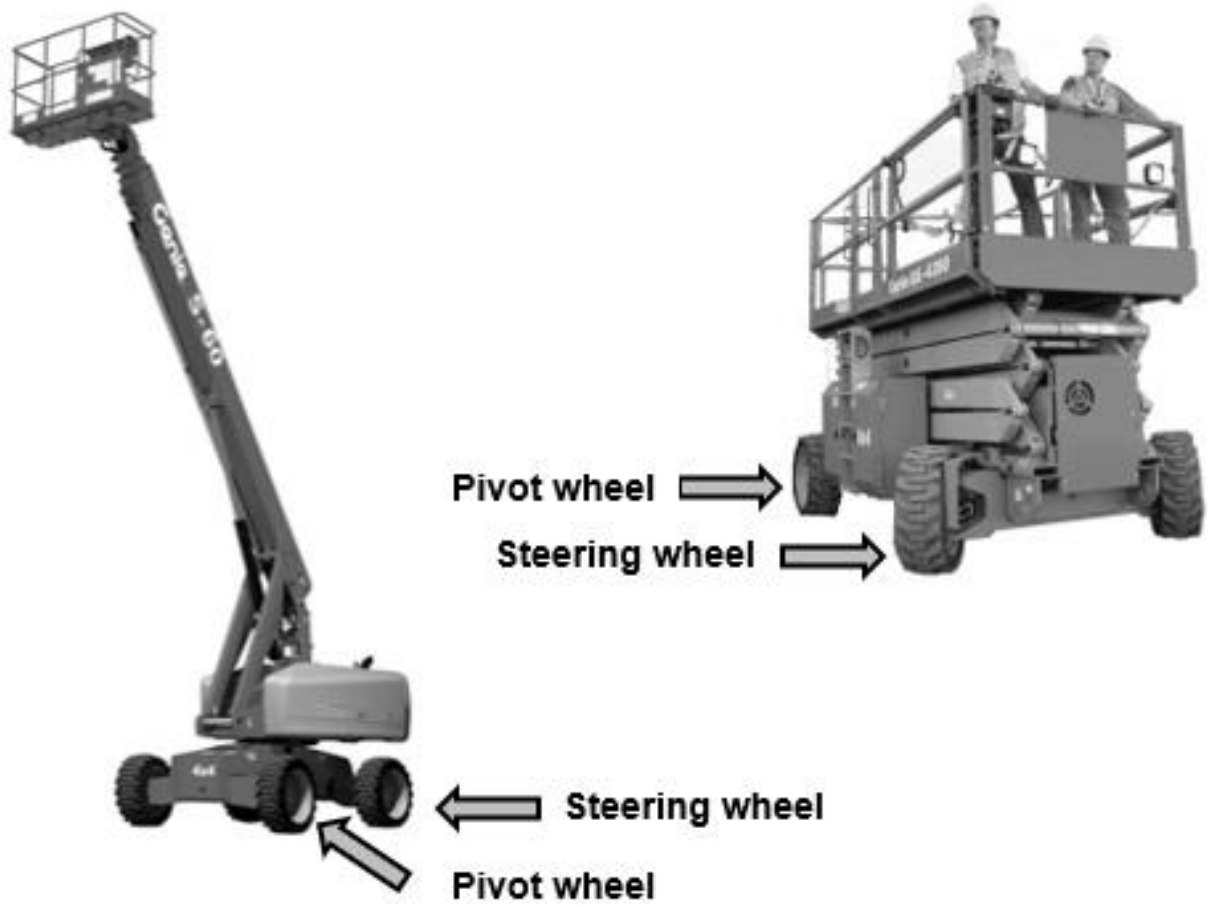

## Strike Points

Whether the equipment is of the smallest size, or the largest size, they are all capable of causing damage to property or injury and even death to workers, if not operated safely.

One of the primary issues an operator should keep in mind to avoid causing damage or injury is to know where the equipment is most likely to strike something.

Incidents usually involve the machine driving forward or backwards and striking something it shouldn't.

Due to the various steering modes of MEWP, the most likely area the equipment will strike an object or person is in the forward most right and left corners of the equipment.

## Primary Strike Points



Slide 167, 168 – WorksafeBC Video

## Stability

- Mobile Elevating Work Platforms (MEWP's) are designed to be stable while performing the duties the MEWP was intended to perform, if the MEWP is operated within the range and scope intended by the manufacturer.
- Even though so much equipment is designed to lift and carry loads under various conditions, the equipment is most stable while it is stopped, sitting level in a neutral position, with its platform placed low to the ground close to the machine.
- Therefore, the stability of the machine will be affected by the forces placed upon the machine while it's performing its duties.

Every operator needs to understand the principles of force, the types of forces, and the affects these forces have upon the stability of the machine they're operating; otherwise, the effects could be quite hazardous to the machine and its operator.

To do this, the operator needs to know the safe operating parameters in which the MEWP can operate.

As discussed earlier, the operator is typically stationed to operate their equipment near the middle of the machine and as a result, would sit centralized within the stability shape of their equipment.

The operator needs to determine what type of stability shape the machine operates under and where the centre of gravity lies within that shape.

To do this, we first need to identify the points of contact the machine has with the ground.

### Points of Contact with the Ground

- MEWP makes contact the ground with at least 3 points, most have 4, some have as many as 6 points that contact the ground.
- Where there are double load bearing wheels, or tandem or triaxles, the centre between the axles or centre between the load wheels is where the true point of contact is concentrated, this is also the pivot point on combination axles.

These points of contact with the ground could be through the machine's wheels, outriggers, skids, tracks, or other similar means.

The bottom dead-centre of the wheels is where we determine the actual contact to be made.

These points outline what we use to determine the centre of the machine, for which the centre of gravity needs to remain within or risk roll-over.

## Stability Shapes

- If the machine has three points of contact with the ground plus a point located near the top of the load at maximum height, we're looking at the shape of a tetrahedron.
- If the machine has four points of contact with the ground plus a point located near the top of the load at maximum height, we're essentially looking at the shape of a pyramid.

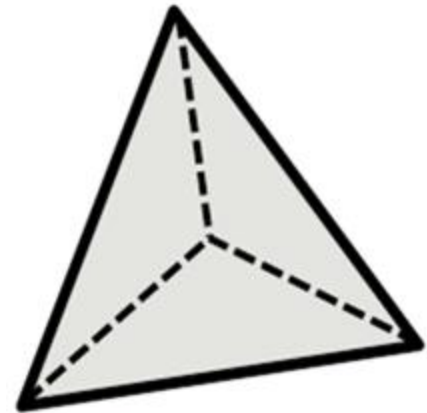

**Tetrahedron**

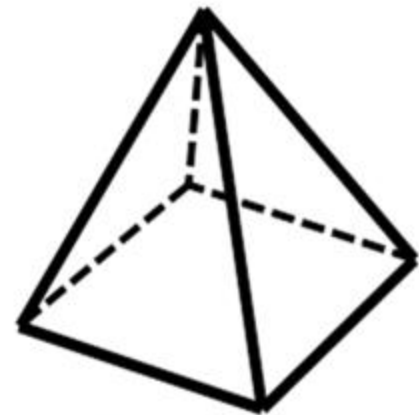

**Pyramid**

Where the equipment is equipped with an oscillating axle, the oscillating point is the point at which all the weight is concentrated; therefore, when we determine how many “true” points are made with the ground, we calculate 3 points rather than 4.



- Because the rear axle oscillates, it is less stable than the front axle.

To determine whether the MEWP is truly under the stability shape of a tetrahedron or a pyramid, one will need to determine whether one of the axles oscillates or not.

## Stability Triangle

- The triangle is measured from the centre of the ground contact.
- These three points of contact connect to create the shape of a triangle.
- The points that connect the front wheels are much broader than the single narrow point on the rear axle of the machine.



- Combining the strength and breadth of the front axle makes the machine more stable in the front than the rear.
- The front axle will pivot on a fulcrum forward and back much easier than it will side to side.
- Because the rear axle oscillates on a single large pin, the rear axle is less stable than the front axle.

## Stability Tetrahedron

- MEWP are intended to lift their load, so we need to consider the lifting height of the equipment and how height influences the stability of the equipment.
- First, determine the maximum height the centre of gravity of the load may elevate to, and then intersect that height with the centre of the equipment thus determining the top-centre point of the equipment.
- Then connect the point at top centre of the machine with the points that outline the stability triangle.





## Stability Rectangle

- Unlike other MEWP that has an axle with a centre pin, there are many styles of equipment that do not have oscillating axles.
- The bottom centre of the four wheels is where we determine true contact to be made with the ground. These four points of contact connect to create the shape of a rectangle.



The Stability Pyramid is created when there are 4 points of ground contact

- Determine the maximum height the centre of gravity of the platform may elevate to.
- Intersect that height with the centre of the machine determining the top-centre point of the machine.
- Connect the point at top centre of the platform with the points that outline the stability rectangle.



## Fulcrum

- Lifting loads with equipment utilizes the theory of balancing a weight over a fulcrum.
- The forward fulcrum on equipment with load runs through the centre of the front plane of the machine's stability shape.

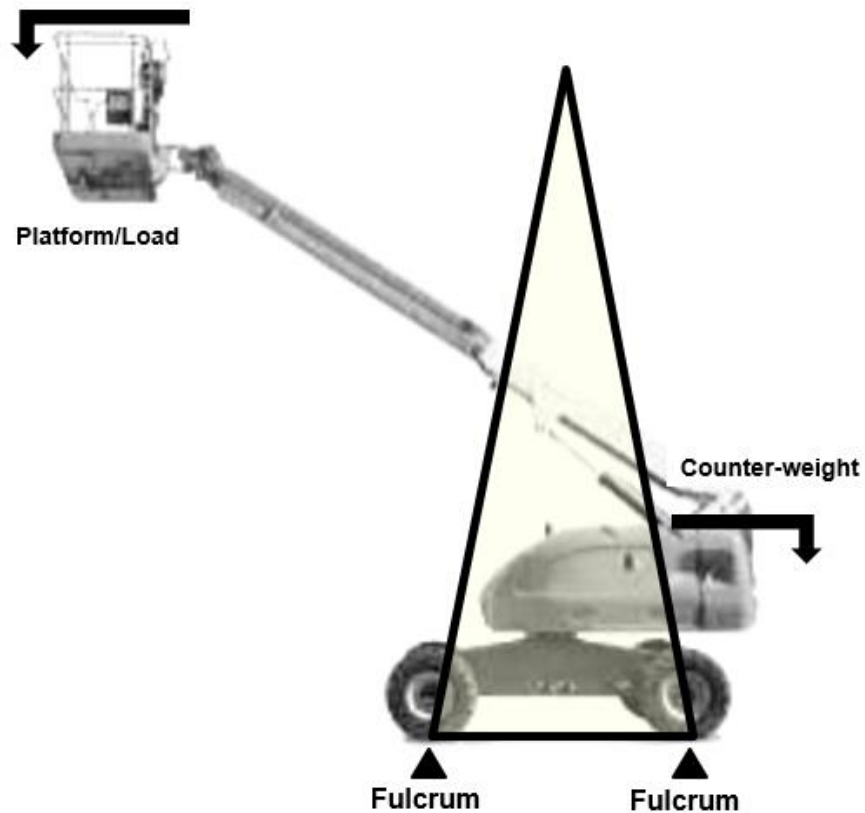

An example of the fulcrum is a “see-saw” or the “teeter-totter” effect

If too much weight is on the front of the equipment', it may tip forward.

- Or, if the machine approaches an incline with the center of gravity facing downslope, the machine may tip forward.

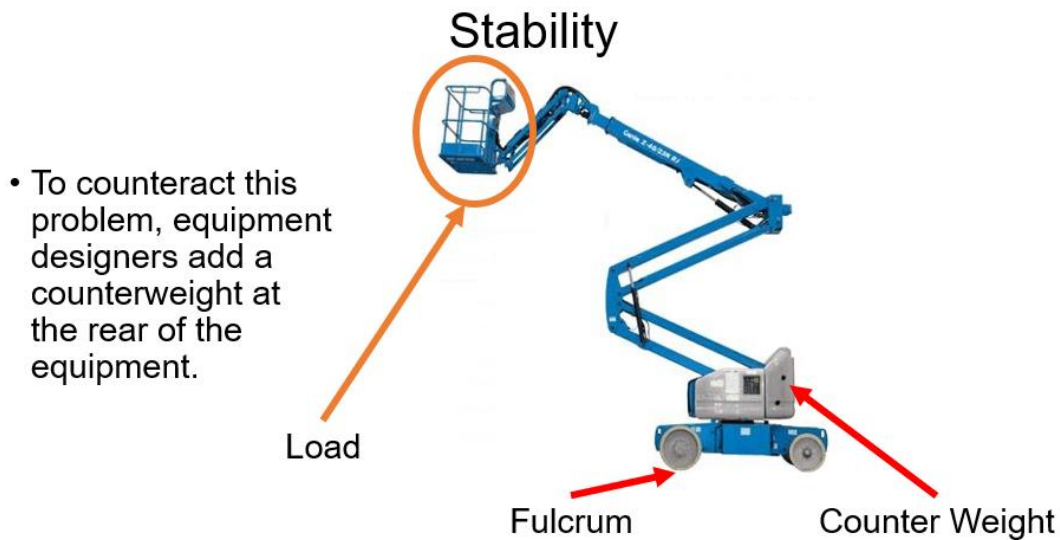

- To counteract this problem, equipment designers add a counterweight at the rear of the equipment.

The other fulcrums are represented on the other planes of the stability shapes.

For machines intended to lift and carry, the purpose of a counterweight is to offset the potential load to be carried.

The counterweight is designed to offset the maximum capacity of the machine lifting the load.

The operator needs to keep in mind that the counterweight is always with the equipment.

As such, the centre of gravity will change as the machine's load varies.

On level ground, 70% of the machines centre of gravity sits over the rear fulcrum due to the counterweight.

At its maximum capacity, 70% of the weight ends up over the forward fulcrum of the equipment.

If the equipment were to ever become loaded beyond capacity, the likelihood of the equipment tipping increases.

## Increased Stability Using Outriggers (Stabilizers)

Although we talk about the support each independent axle provides to the machine, we need to look at the equipment as a complete unit on a solid supporting frame.

Some MEWP's often use stabilizers, otherwise known as outriggers.

When raising the platform, it is always best that you use your stabilizers to increase the stability of your machine.

- Outriggers play an important function to keep your equipment stable.
- Outriggers are always required when the load chart says to and will keep the machine more stable especially on uneven or soft terrain.
- When outriggers are used, the fulcrum shifts from the wheels to the centre of the outriggers.





Note the outrigger pads being used on this MEWP  
Always a good idea...  
A must if ground stability is unknown.

This Page Left Blank  
Intentionally

## Center of Gravity of Machine

- Operators need to pay special attention to the center of gravity on their MEWP because it can shift outside the stability shape causing instability and possible roll-over.
- All MEWP have a Centre of Gravity located somewhere within the equipment's stability shape.
- Consider these "balance points" or "fulcrums" to be the outside of the equipment's stability shape".
- Equipment is stable, if operated as intended by the manufacturer.
- Equipment is most stable while stopped, level, with platform low to the ground and close to the equipment, it is under these conditions that maximum capacity can be attained.
- Once the centre of the machine is located, we need determine where the equipment's centre of gravity lays within its stability shape.
- Remember, the closer the centre of gravity lies to the centre of the equipment, the more the equipment becomes stable.
- Conversely, the further the centre of gravity gets away from centre of equipment, the less stable it becomes.
- As a platform is lifted, the center of gravity moves up along the pyramid/tetrahedron where the top becomes narrower.
- It can be clearly seen that the higher the platform is lifted the less room you have within the stability shape.
- If the center of gravity falls outside the stability shape the equipment will become unstable and risk tipping over.



The images below illustrate how the centre of gravity shifts towards the front fulcrum and counterweight until the platform is lifted.

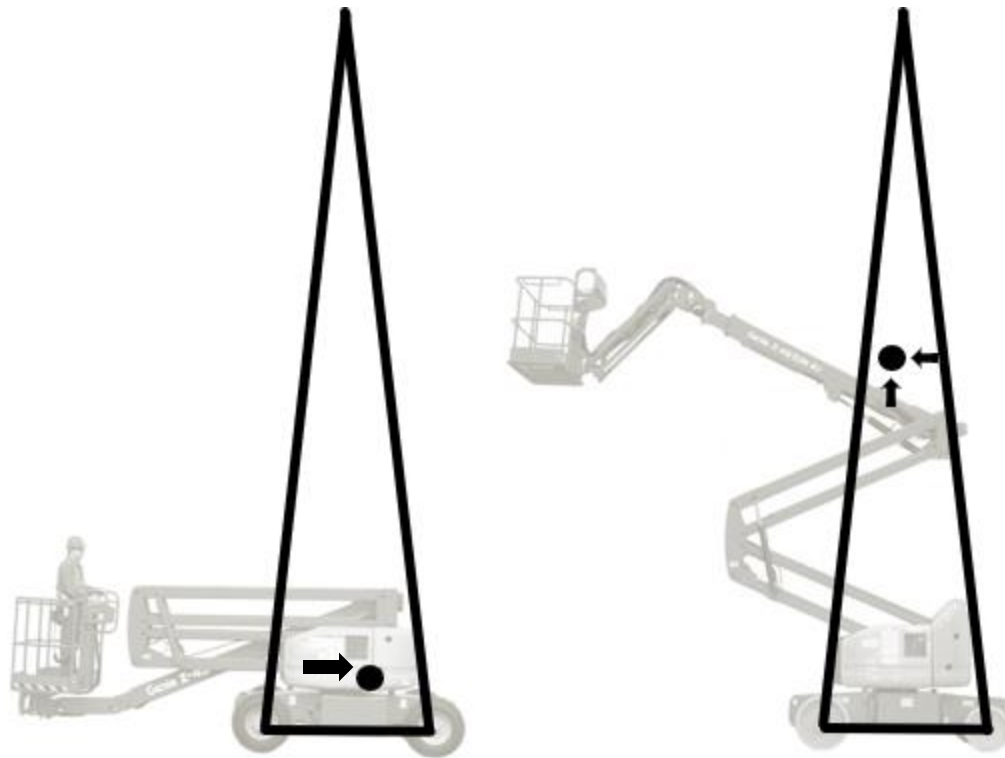

Because the center of gravity (depicted by the solid circle) lies within the stability tetrahedron, the machine remains within its range of stability.

Operators need to pay special attention to the center of gravity on their MEWP because it can shift outside the stability shape causing instability and possible roll-over.

The counterweight is designed to offset the maximum capacity of the machine lifting the platform.

Looking at the stability tetrahedron, we can see that the centre of gravity falls well inside of it.

The heavier the load carried, or the further the load extends, the more the centre of gravity will shift toward the fulcrum.

If the load exceeds the capacity of the equipment, the center of gravity will shift beyond the fulcrum and tip it forward.

Because the center of gravity (depicted by the solid circle) lies within the stability tetrahedron, the machine remains within its range of stability.

The image illustrates what happens when the center of gravity falls outside of the stability tetrahedron.



## Static vs. Dynamic Stability

Now that we understand the principles of stability, we need to consider the effect of motion on the equipment's stability.

When an object is stationary (not moving), it is said to be in the state of static equilibrium.

When an object is in motion it is said to be dynamic, or constantly changing its stability.

It is important to understand the difference between the two because it greatly influences the stability of the equipment while in use.

Operators should know how the center of gravity of the MEWP with and without maximum load, as well as an incline or slope of the surface influence the machine they're operating.

The easiest way to look at these forces is to consider the pendulum effect of objects in motion.

Consider a pendulum hanging inside the stability shape, if we were to accelerate the equipment (in a forward direction) what do you think would happen to the center of gravity?

Initially the pendulum ball would stay static relative to the ground, however, as the equipment moves forward, which in turn (relative to the equipment) would move the pendulum ball towards the rear point of equipment's stability shape.

Theoretically it is possible to move the pendulum ball past this point resulting in equipment tip-over.

Fortunately, equipment design restricts this from happening.

For example, if we looked at a motorcycle the same theory would apply.

If a motorcycle accelerates too fast, it would flip backwards injuring the operator.

The opposite effect happens when you stop or slow down too quickly, the pendulum swings forward towards the forward fulcrum.

If the equipment was to stop too fast while loaded, the pendulum could swing beyond the fulcrum and cause the equipment to tip forward most likely injuring the operator.

## Lateral and Longitudinal Stability



- Operators should remember, if the machines lateral plane is shorter than its longitudinal plane, it will be less stable side to side.
- The same is true if your equipment has a shorter longitudinal plane; it will be less stable end-to-end.

- Longitudinal Stability: Stability of the equipment from front to back.
- Lateral Stability: Stability of the equipment from side to side.



Maximum stability is achieved if the machine is level.

If stabilizers are available, use them to keep the MEWP level.

You should never drive with a platform raised across a slope or grade; there is a high chance that the equipment could lose lateral stability.

If stabilizers are not available, consider repositioning your machine to more level ground.

It is important to check tire pressures to avoid upsetting the lateral stability of the machine.

Remember it is easier to become laterally unstable because of the narrower points of contact with the ground.

It is always best to keep the machine perpendicular to a building to keep it longitudinally stable.

For MEWP with the stability shape of a tetrahedron the operator should realize that lateral stability decreases with lighter load, especially at height due to the narrow points at the rear of the tetrahedron.

MEWP with the stability shape of a pyramid is more stable at the rear than the rear of MEWP using the tetrahedron.

The following illustrate both the lateral and longitudinal axis from the top and side view of the machine's stability shape.

**Top view**

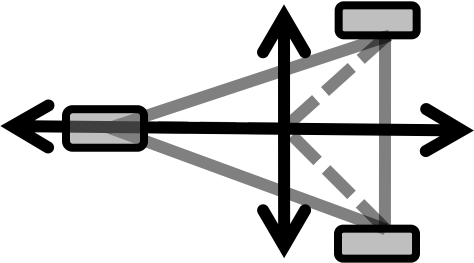

**3 dimensional views**

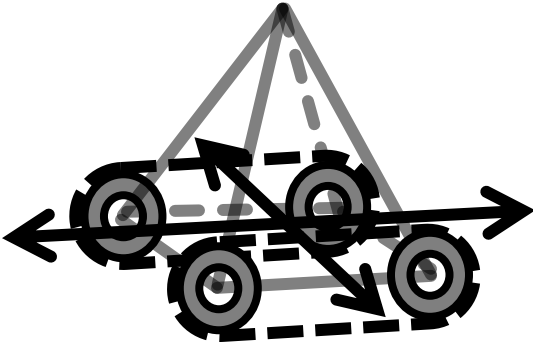
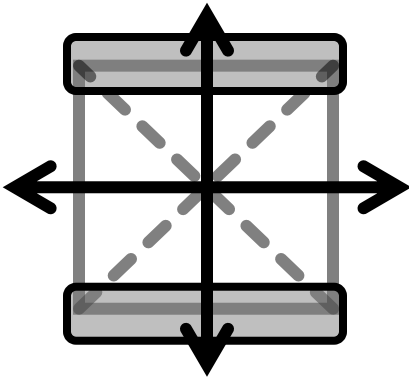
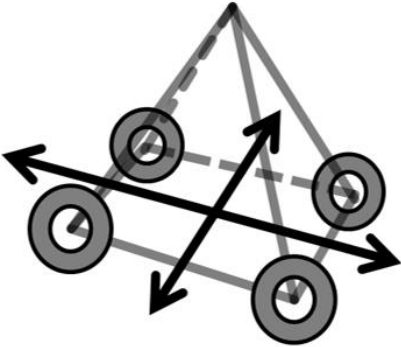
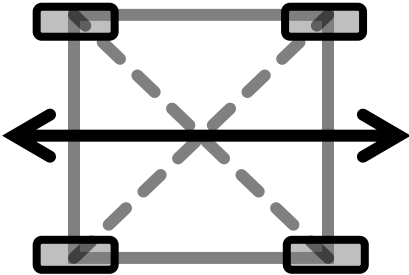
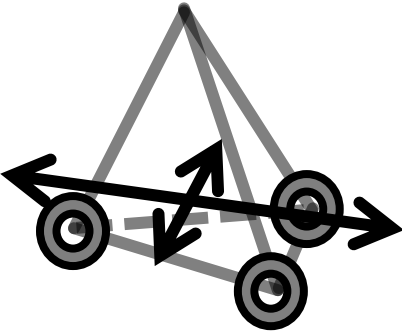

## Factors Affecting Stability

- Understanding the principles of stability allow operators to understand the factors that can influence the MEWP's stability.
- No matter where the MEWP is operating, there will always be a variety of forces acting against the stability of it.
- Consider the effect of leverage, centrifugal and centripetal force, wind and the terrain.
- The equipment has been designed to work in a variety of conditions including rough, uneven and sloping terrain which will subject the equipment to forces affecting both the longitudinal and lateral stability of the machine.
- Understanding longitudinal and lateral stabilities of your MEWP is especially important when operating on slopes and inclines.

## Leverage

- MEWP with a lighter load will have its centre of gravity located towards the back of the equipment, or rear fulcrum.
- Once the boom has been extended the force of leverage will drive the centre of gravity from the rear fulcrum of the equipment towards the front fulcrum.
- This is further compounded when the platform is elevated.

Operators need to consider the effect of leverage upon their equipment.

Operators need to remain aware of the leverage effect while operating; the consequences of a roll-over could be disastrous.

As the centre of gravity shifts forward past the fulcrum, the equipment will tip over frontwards.

To prevent this from happening, equipment manufacturers restrict the equipment's operating capacity to be less than the machine's tipping capacity.

If the machine were to ever become loaded beyond capacity, the likelihood of the machine tipping forward increases.

Operators should always travel with the platform as close to the machine and as close to the ground as possible while still being able to clear any ground obstructions.

## Maximum Reach

- When the platform is raised to a position level with the horizon and extended to its maximum distance from the machine, the platform will be at its furthest point away from the nearest fulcrum, or balance point; this point is known as the maximum reach.

It only makes sense that this will be the most dangerous place to hold a platform.





## Envelope Management Systems (EMS)

- Lifts that elevate higher than 85 feet / 27 meters will have an EMS.
- Due to the extreme heights that these machines can reach the EMS must be tested for proper functionality prior to operation, if the EMS is not working properly, and the unit extends beyond its range of motion, a catastrophic incident could happen.
- Every unit has their own specific test so consult the operator's manual and ensure you have been trained on each new machine prior to operation.
- This complex system monitors boom height, length and angle to keep the operator within a safe Range of Motion.

Typical Range of Motion Chart

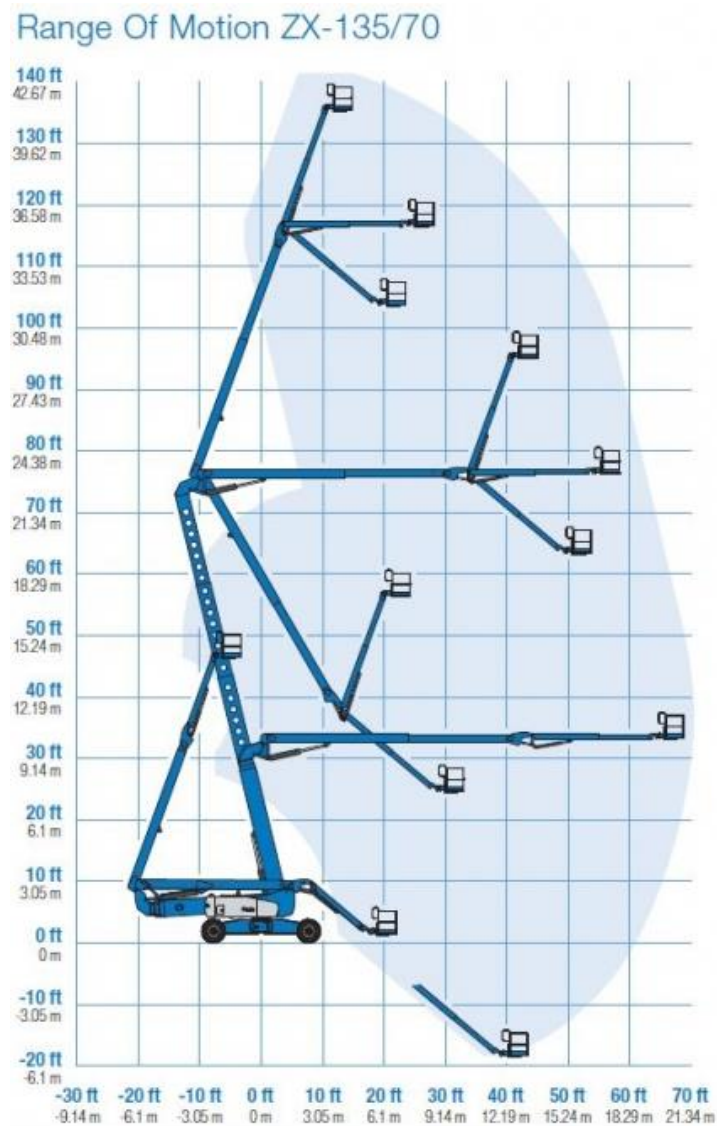

## Centrifugal Force

- The effects of speed, acceleration, sharp cornering, height, grade or ramps and load all combine to affect the lateral stability of the equipment.
- Centrifugal force occurs when mass is fleeing from the inside towards the outside. It is caused by inertia.
- Centrifugal force is applied to the mass sitting above the equipment's centre gravity.
- Centrifugal force occurs when equipment in motion turns a corner.
- Due to the principle of centrifugal force the pendulum would swing to the outside and could possibly tip the equipment on its side.
- Circular motion cannot occur without a force pulling toward the centre, that is centripetal force.

## Centripetal Force

- Centripetal force is the equal and opposite of centrifugal force.
- This is a force that moves towards the centre.
- Centripetal force is applied to the mass sitting below the equipment's centre of gravity.
- Like centrifugal force, centripetal force occurs when equipment is turning a corner.
- Deceleration contributes to the effect of centripetal force.

Slide 204 – Fire Truck Roll Over Video

## Wind

- It is important to take wind load into account when performing your hazard assessment.
- Always refer to the operator's manual to determine safe operating conditions due to wind load.
- Tarping in a platform will increase the effect of wind and may not be allowed by the manufacturer.

Sudden wind gusts applied against the machine and can be enough to cause tip-over.

The effect of wind is compounded by having the platform at height giving it the effect of a wind sail.

It can be especially disastrous if workers are elevated in a work platform.

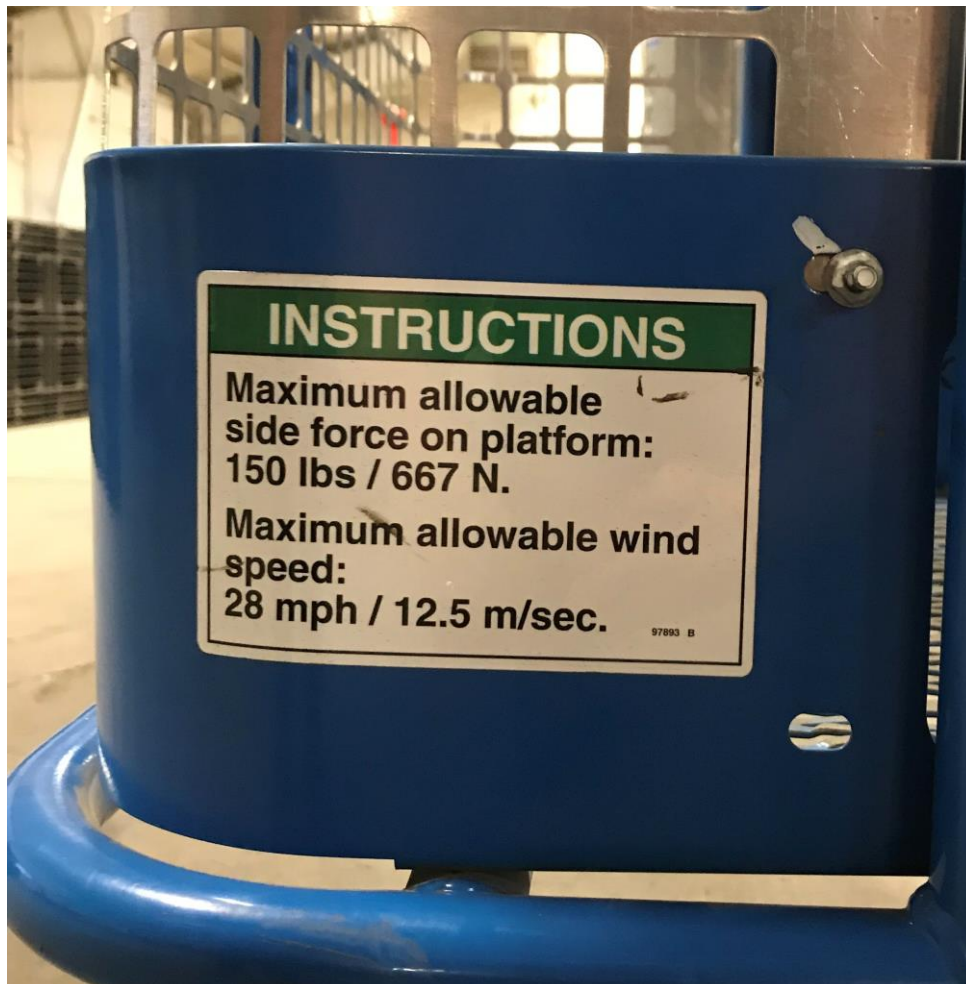

Slide 206 – Miller Park Wind Incident

## Mobile Elevating Work Platforms on Inclines

If the ground conditions and traction are suitable, the scissor lift can travel on an incline either forward or backwards. However, if traction is suspect, the scissor lift operator should always keep the drive wheels pointing down the incline while travelling up and down. This allows for the weight of the machine to shift over the drive wheels for maximum traction.

### Correct Way to Travel Uphill with Scissor Lift

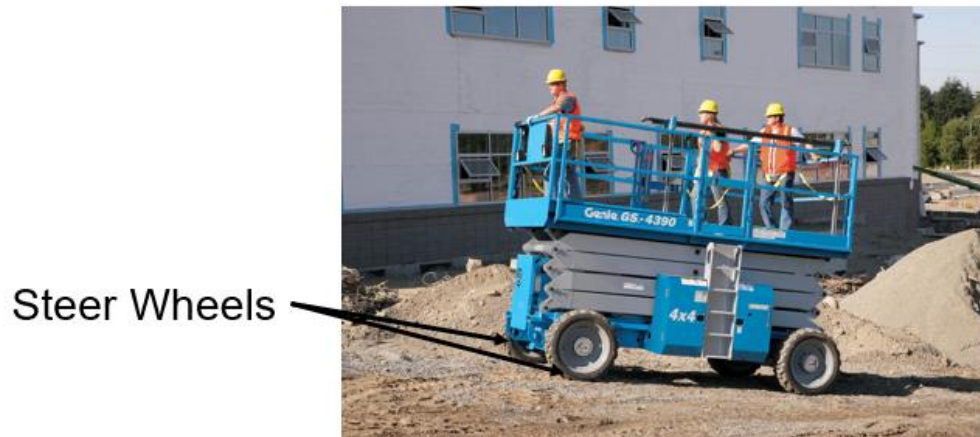

If you are moving a Scissor Lift up or down a hill, always travel with the steer wheels pointing up the hill.

A boom lift operator faced with travelling up or down an incline should know that based on the principles of the stability shape, the force of leverage caused by the counterweight will drive the centre of gravity towards the rear fulcrum.

With this in mind, boom lifts should travel up and down an incline with the counterweight facing uphill. This shift in the centre of gravity will allow the machine to become more stable than the opposite.

Because the boom acts as a cantilever and transfers the weight of the boom to the counterweight so a boom lift will often have the boom and basket behind as it is moved up an incline.

### Correct Way to Travel Uphill with Boom Lift

Weight is also transferred from the boom to the rear boom connecting pins.

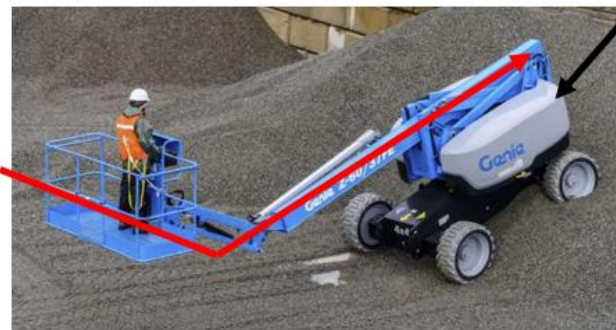

Counterweight

If you are moving a Boom Lift up or down a hill, always travel with the counterweight uphill.

This would explain why you see boom lifts loaded on trailers like this – with the basket and boom at the rear of the trailer.



## Side Slopes

- Side Slopes have a serious effect on the lateral stability of the equipment.
- Due to the relatively narrow shape of the stability tetrahedron, degree of slope and height of the platform combined will cause the equipment to become unstable quickly.
- Try to avoid operating on side slopes.

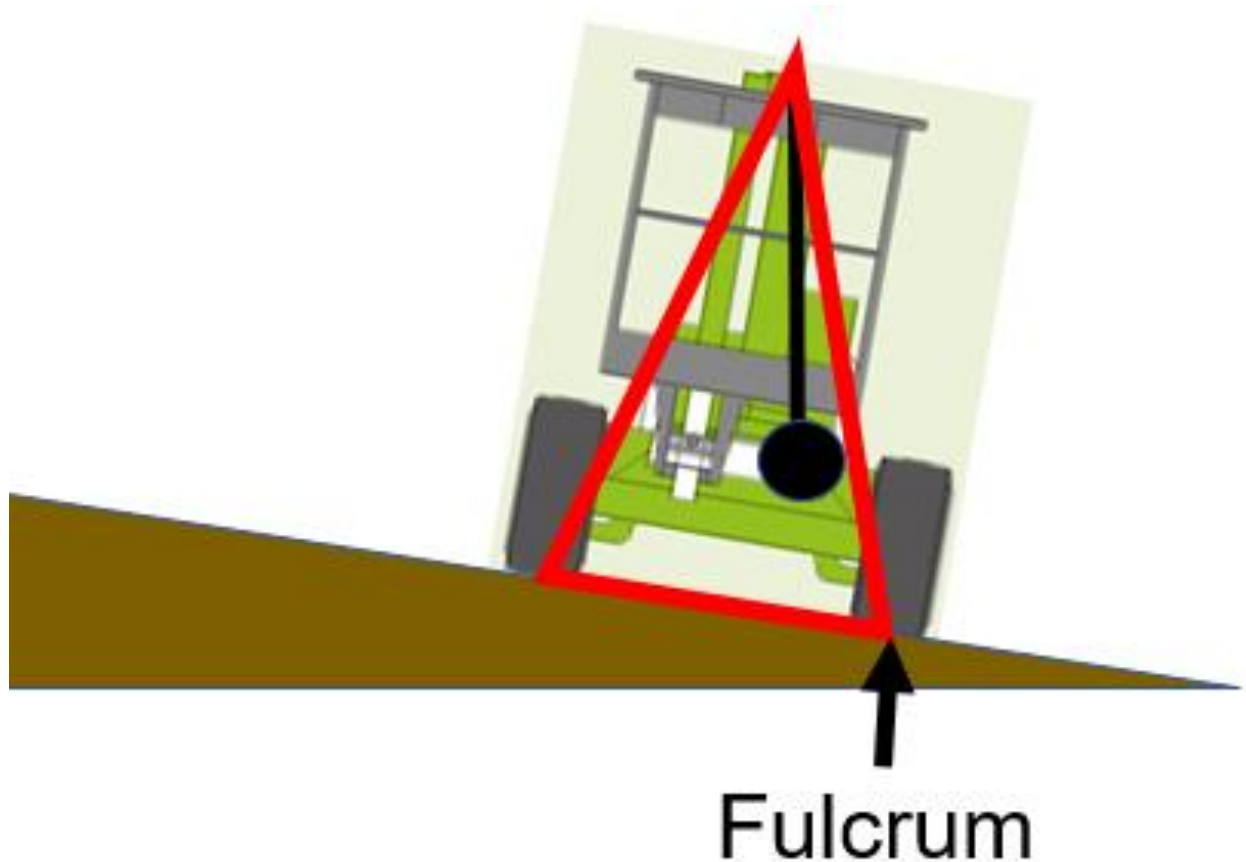

Slide 220 – 60 ft. Boom Lift on Side Slope Video

- If you must travel on a side slope, it is very important to keep the platform as close to the ground as possible.
- Due to the cross angle of the slope, the treads on the equipment tires and tracks may not provide as much traction as expected.

## Mobile Elevating Work Platforms on Side Slopes

When the boom or scissor attachment is raised it loses stability. Do not raise the platform unless the machine is on a firm, level surface. Don't depend on the tilt alarm as a level indicator. The tilt alarm sounds on the chassis only when the machine is on slope.



If the tilt alarm sounds;

Move the machine to a firm, level surface.

If the tilt alarm sounds when the platform is raised, use extreme caution to lower the platform.

Do not drive over 0.8 km/h with the platform raised.

Use extreme care and slow speeds while driving the machine in a stowed position across uneven terrain, debris, unstable or slippery surfaces and near holes and drop-offs. Do not drive the machine on or near uneven terrain, unstable surfaces or other hazardous conditions with the platform raised.



Always refer to the machine specific operator's manual for incline and side slope ratings.

## Tips for Operating on Inclines and Slopes

Always refer to the operator's manual for maximum slide slope operation.

Eliminate the hazard when ever possible, try to avoid working on inclines and side slopes.

Check out all slopes and inclines before beginning travel.

Take measures to reduce the risk of losing control or rolling over, for example:

Attempt to build a flat pad to work from when conditions permit.

Pile material on the uphill side of the slope.

Look for water, ice, snow, or other debris that makes travel hazardous.

Always travel in the center portion of the slope or incline.

Always keep the platform low and level when traveling on any type of slope.

Travel straight up or down and incline. Avoid crossing a slope.

Never turn or raise the platform on an incline.

When the platform is raised, less movement will be necessary to turn the equipment on its side.

Never attempt to turn or travel with the platform at height.

Never raise a platform if the equipment is facing downhill; this will cause the back of the equipment to leave the ground easier and less weight is needed to create an out-of-balance condition.

Avoid sudden or jerky moves when the platform is raised on a slope or incline.



## Capacity Restrictions

- Do not overload the basket.

Example of a Capacity Label

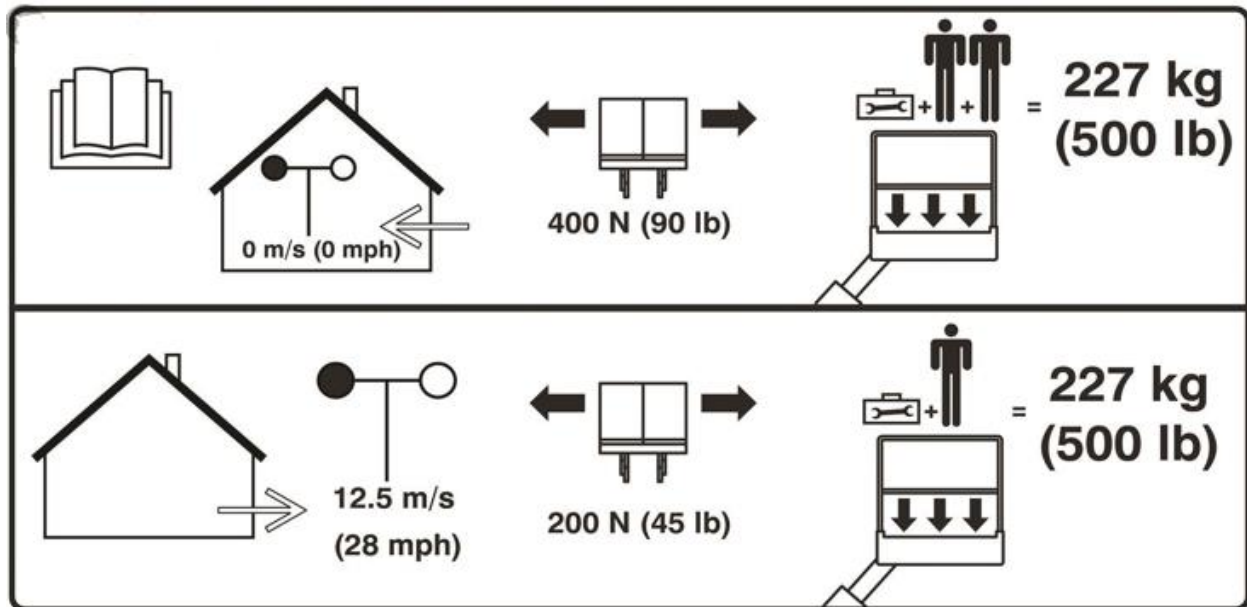

- If the machine is used beyond the manufacturer's rated capacity, the manufacturer may void any warranty leaving the operator and employer liable for anything that goes wrong while using the machine beyond the machines scope.

To achieve maximum capacity on equipment the:

- Vehicle must be stopped.
- Vehicle and basket must be level.
- Basket must be retracted and lowered.
- Terrain must be flat and solid



## Caution

If your machine feels unstable when the boom is raised and extended, always retract the boom before lowering it.

## Chapter 5 Summary:

### What was Covered in Chapter 5?

- The student will be aware of common types of MEWP.
- The student will be familiar with the basic structural components of MEWP and how they function.
- The student will be aware of potential hazards while operating MEWP and how to control those hazards.
- The student will have basic knowledge of operating MEWP.

### What's New?

Be prepared for new CSA (B354) and ANSI (A92) Standards for MEWP expected to be released March, 2020.

### Highlights:

- Equipment Terminology
- Equipment Design Standards
- Safe Use and Planning
- Risk Assessment Planning
- Training (Operators, Supervisors, & Occupants).
- Maintenance and Repair Personnel Training

The End.