



Lift Truck Operator Certification Manitoba OH&S Compliant



Lift Truck Operator Certification

Manitoba OH&S Compliant

First Edition

May, 2021

No part of this manual may be reproduced in any form or by any means, for any purpose without the express written permission of Saga Universal Training Corporation

Saga Universal Training Corp. is dedicated to reducing deaths caused by illness and injury. The goal of this program is to ensure operators have the **basic knowledge and skills** required for the safe operation of their equipment and its attachments. However, due to the different types of Mobile Equipment, certain statements in this program may not apply.

Job and/or familiarization of operators for particular machines or specialized equipment used in specific workplace environments are in addition to this training. It is expected that an employer will take the fundamentals of this training and apply them to their specific machine and workplace.

Readers should not assume that reviewing this manual alone constitutes complete equipment operator training.

For further information contact:

Saga Universal Training Corporation

E: mail – info@sagatraining.ca

Web Page – www.sagatraining.ca

Saga Universal Training Corp. wishes to acknowledge the efforts of all the people who contributed to the writing, editing, and layout of this manual. It is our hope that this manual and the resulting training program will aid in the reduction of preventable injuries and property damage with the necessary knowledge, skills and confidence to operate Mobile Equipment safely.

Table of Contents

DISCLAIMER	7
COURSE DESCRIPTION	8
PROGRAM OVERVIEW	8
CERTIFICATION:	8
MANITOBA CERTIFICATION REQUIREMENTS	8
COURSE GOALS:.....	9
CHAPTER 1 OVERSIGHT:	11
LEGISLATION.....	13
STANDARDS.....	14
DUE DILIGENCE	16
BEST PRACTICES	16
REQUIREMENT TO COMPLY	17
CHAPTER 2: ENSURING A SAFE WORKSITE	20
MANITOBA LEGISLATION AND REGULATIONS	21
EMPLOYER RESPONSIBILITIES	21
EMPLOYEE RESPONSIBILITIES	23
ELEMENTS OF A HEALTH AND SAFETY PROGRAM FOR EQUIPMENT OPERATORS:	24
<i>Familiarization Training</i>	24
OPERATOR'S MANUAL	27
HAZARD ASSESSMENT	29
FACILITY DESIGN & WORKPLACE REQUIREMENTS.....	31
CHAPTER 3: INSPECTIONS AND MAINTENANCE	34
CHAPTER 3: INSPECTIONS AND MAINTENANCE	34
INSPECTION DEFICIENCIES	41
LOCK-OUT / TAG-OUT PROCEDURES	42
MODIFICATIONS	44

CHAPTER 4: SAFE OPERATION OF LIFT TRUCKS.....	46
GENERAL OPERATION	47
BASIC SAFETY RULES.....	48
BASIC OPERATING PROCEDURES	49
ESSENTIAL QUALITIES OF AN EQUIPMENT OPERATOR.....	53
SPECIAL HAZARDS:	56
HYDRAULIC OIL INJECTION INJURY.....	57
TRANSPORTING THE EQUIPMENT SAFELY.....	62
CHAPTER 5: LIFT TRUCKS	66
FUNCTIONAL ASPECTS OF MOBILE EQUIPMENT.....	72
STEERING AND TURNING DYNAMICS	76
STABILITY	79
SLOPES AND INCLINES	100
INCLINES	101
CHAPTER 6: ATTACHMENTS AND HANDLING MATERIAL	107
ATTACHMENTS	108
CONNECTING HYDRAULIC LINES:	109
CAPACITY RESTRICTIONS	110
LOAD CENTRE AND LOAD CENTRE OF GRAVITY	114
LOAD CHARTS	115
CHAPTER 7: BASIC OPERATION OF MOBILE EQUIPMENT.....	118
USING FORKS	119

DISCLAIMER

The information contained in this manual is intended to supplement the specific information that is contained in the Mobile Equipment manufacturers' operating manual(s).

It is expected that an employer will take the fundamentals of this training and apply them to their specific machine and workplace.

Job and/or familiarization of operators for particular machines or specialized equipment used in specific workplace environments are in addition to this training.

Although every effort is made to ensure the accuracy, currency and completeness of the information, Saga does not guarantee, warrant, represent or undertake that the information provided is correct, accurate or current. Saga is not liable for any loss, claim, or demand arising directly or indirectly from any use or reliance upon the information.

In this course the participant is responsible for researching and determining the specific legislation and regulations that apply to them.

COURSE DESCRIPTION

Program Overview

- The course takes into consideration the guidelines and principals of the Canadian Centre for Occupational Health and Safety (CCOHS).
- The course provides the minimum requirements for the training of operators for lift trucks and is intended to supplement a company's larger Health & Safety Management System.
- In this course the participant is responsible for researching and determining the specific legislation and regulations that apply to them.

Certification:

- At the end of each chapter there will be a multiple choice, open-book exam of which, at least 80% correct must be achieved.
- Certificates of training issued by Saga Universal Training Corp. must be recognized by the employer and are valid for 3 years from the date of completion.

Manitoba Certification Requirements

- Employer to Ensure Competency of Powered Lift Truck Operators
- Even though training can be acquired from outside agencies, employers must ensure employees are competent in their work environment with the equipment they must use and issue a certificate indicating this. Once certificates are issued, the employer must develop an evaluation system to ensure ongoing competency of operators.
- This shall include, but not be limited to:
 - testing on operation of the powered lift truck.
 - knowledge and skill level regarding the lift truck
 - company policy and procedure relating to its operation.

This evaluation will assess the need for further training, updates or refresher courses. This training shall be documented and be made available to a safety and health officer of the Workplace Safety and Health Division whenever requested.

All operator training and evaluation shall be conducted by persons who have the knowledge, training and experience to train powered industrial truck operators and evaluate their competence.

Information to be included on the certificate: 1) company name (and name of training agency, if applicable) 2) employee name 3) date of issue 4) type of equipment certified to use 5) signature of employer and instructor

Course Goals:

- The student should have an awareness of the various legislation, regulations, and standards that pertain to lift trucks.
- The student should understand the roles and responsibilities of employers and employees as they relate to the operation of lift trucks.
- The student should understand the importance of lift truck inspections and how to conduct the inspections safely.
- The student should be familiar with safe operating procedures for lift trucks.
- The student should be familiar with different types of lift trucks, their basic structural components, basic function, potential hazards while operating lift trucks and how to control those hazards.
- The student should have a basic understanding of the proper use of lift truck attachments and potential hazards associated with Mobile Equipment attachments.
- The student should have a basic understanding of the operation of the most common lift trucks.

Exposure to Harm

- Of all the workers who have been exposed to harm causing injury or illness, one worker will die from that exposure on average, every second day.
- Most will succumb later in life due to an exposure that occurred earlier in their life.
- Operating lift trucks can be one of the most dangerous jobs a worker can have.

Incidents according to Equipment

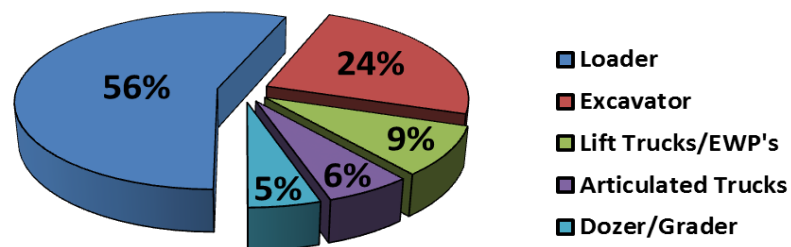

Incidents according to Activity

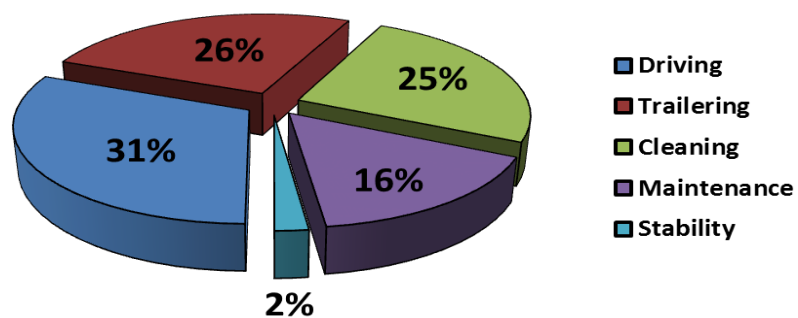

Univ.-Prof. Dr.-Inghabil. H. Tudeshki

- DiplIng. M. Könnecke
- Of all the workers dying from a workplace exposure, the majority were workers attempting to rescue others.
- Many of them did not have the proper training, equipment, or support to perform the rescue, but felt a moral obligation.
- If a worker is not trained to perform rescue, the worker should be trained not to attempt.

CHAPTER 1 OVERSIGHT:

There are many layers of oversight of safety requirements in the workplace that are often in a hierarchical form of priority. For example, federal laws and regulations normally supersede provincial authority, but in some instances the federal government has given authority to the provinces.

Goal:

The student should have an awareness of the various legislation, regulations, and standards that pertain to Mobile Equipment.

Objective:

1. The student should understand the relationship between Legislation, Regulations, Standards, Due Diligence, and Best Practices.

Legislation

Criminal Code of Canada Section 217.1

- One of the farthest-reaching mechanisms of oversight regarding health and safety is Section 217.1 of the Criminal Code of Canada, it is where “due diligence” is defined in law:

“Everyone who undertakes, or has the authority, to direct how another person does work or performs a task is under a legal duty to take reasonable steps to prevent bodily harm to that person, or any other person, arising from that work or task.”

Canada Labour Code Part II

- In Canada OH&S is a provincial jurisdiction and every province has its own OH&S legislation, code, and regulations.
- However, some industries are federally regulated, which can bring OH&S for those industries under the Canadian Labor Code and under federal jurisdiction.
- Federal health and safety legislation are found in Part II of the Canada Labour Code and Regulations.
- The Canada Labour Code applies to employees of the Federal Government, the Post Office, airports, banks, canals, highway transport, pipelines, radio and television broadcasting, railways, shipping services, and many more.
- All Provinces and Territories must meet the minimum requirements of the Canada Labour Code and Regulations in their own legislation and are certainly encouraged to exceed them.
- Approximately 90% of the Canadian workforce falls under the OH&S legislation of the province or territory in which they work.

Provincial Legislation and Regulations

Occupational Health and Safety legislation, regulations and codes apply to every occupation, employment and business with few, if any, exceptions.

Regulations

- Workplaces must meet the minimum requirements of OH&S Regulations but are also encouraged to exceed them.
- Whether the workplace simply meets or chooses to exceed the minimum of the Provincial regulations, the employer should document their regulations into the company's safe work policies and procedures manual.

Standards

- OH&S regulations often refer to standards where the regulation will require the worker to follow a specific standard or use equipment that has met the requirements of a specific standard.
- The standards organizations are not the government so they cannot implement regulations.

However, the standards organizations are made up of experts in various disciplines. The standards organizations most frequently referenced in OH&S regulations are:

- CSA Group, formerly the *Canadian Standards Association* (CSA) (CAN/CSA)
- American National Standards Institute (ANSI)

Others Include:

- American Society of Safety Engineers (ASSE),
- European Committee for Standardization (CEN), or in French: (Comité Européen de Normalisation) Conformité Européenne (CE),
- National Fire Protection Association (NFPA),
- Underwriters Laboratories (UL),
- Underwriters Laboratories of Canada (ULC),
- Safety Equipment Institute (SEI).

For compliance purposes, any equipment required to meet specific standards must bear the mark or label of a nationally accredited testing organization such as CSA or ANSI, as evidence that the equipment has been approved to the requirements of the Standard.



Use caution when purchasing equipment required to meet the various standards. Manufacturers must meet stringent criteria to have their equipment tested to these standards. There have been cases of fraud where equipment has not been tested to the standards criteria and counterfeit marks are placed on the equipment. It is always best to purchase equipment from reputable and authorized dealers.

The Bottom Line

When a regulation requires certain standards to be followed, they must be followed just as if they were written verbatim in the regulation.

Due Diligence

- Applied to occupational health and safety, due diligence means that employers shall take all reasonable precautions, under the particular circumstances, to prevent injuries or accidents in the workplace.

Note: The wording is very similar in the Criminal Code of Canada Section 217.1.

Best Practices

- A best practice is a method or technique that has been generally accepted as superior to any alternatives because it produces results that are superior to those achieved by other means, or because it has become a standard way of doing things.
- Best practices are used to maintain quality as an alternative to mandatory legislated standards and can be based on self-assessment or benchmarking.
- A procedure that has been shown by research and experience to produce optimal results and that is established or proposed as a standard suitable for widespread adoption.
- There are some standards that are not required to be followed by any regulations, but individuals and groups follow them because they produce results.

Best Practice vs. Due Diligence

- If due diligence in health and safety means to take all reasonable precautions, and best practices are used to maintain quality as an alternative to mandatory legislated standards; then wouldn't following best practices be considered an example of due diligence?
- A standard not required through a regulation but has been generally accepted as superior could be considered a best practice and therefore should be followed to meet due diligence.

Note: Can you think of an example of best practices and due diligence being followed at your worksite?

Reasonably Practicable

- In OHS the term "reasonably practicable" is frequently used.
- Reasonably practicable is a recognized term that is assessed using the reasonable person test.
- That is, what would a dozen of your peers consider reasonable in similar circumstances.
- Your peers would likely review what you did and compare it to what they do in their own operations.
- Some might do more, others less.

Requirement to Comply

Notwithstanding the requirement for competency (training and experience), appropriate equipment, and the right to refuse unsafe work:

- If legislation, regulations, or an adopted code imposes a duty on an employer, the employer must ensure that duty is met in accordance with the legislation, regulations, or the adopted code.
- If legislation, regulations, or an adopted code imposes a duty on a worker, the worker must perform that duty, and the employer must ensure the worker performs that duty in accordance with the legislation, regulations, or the adopted code.

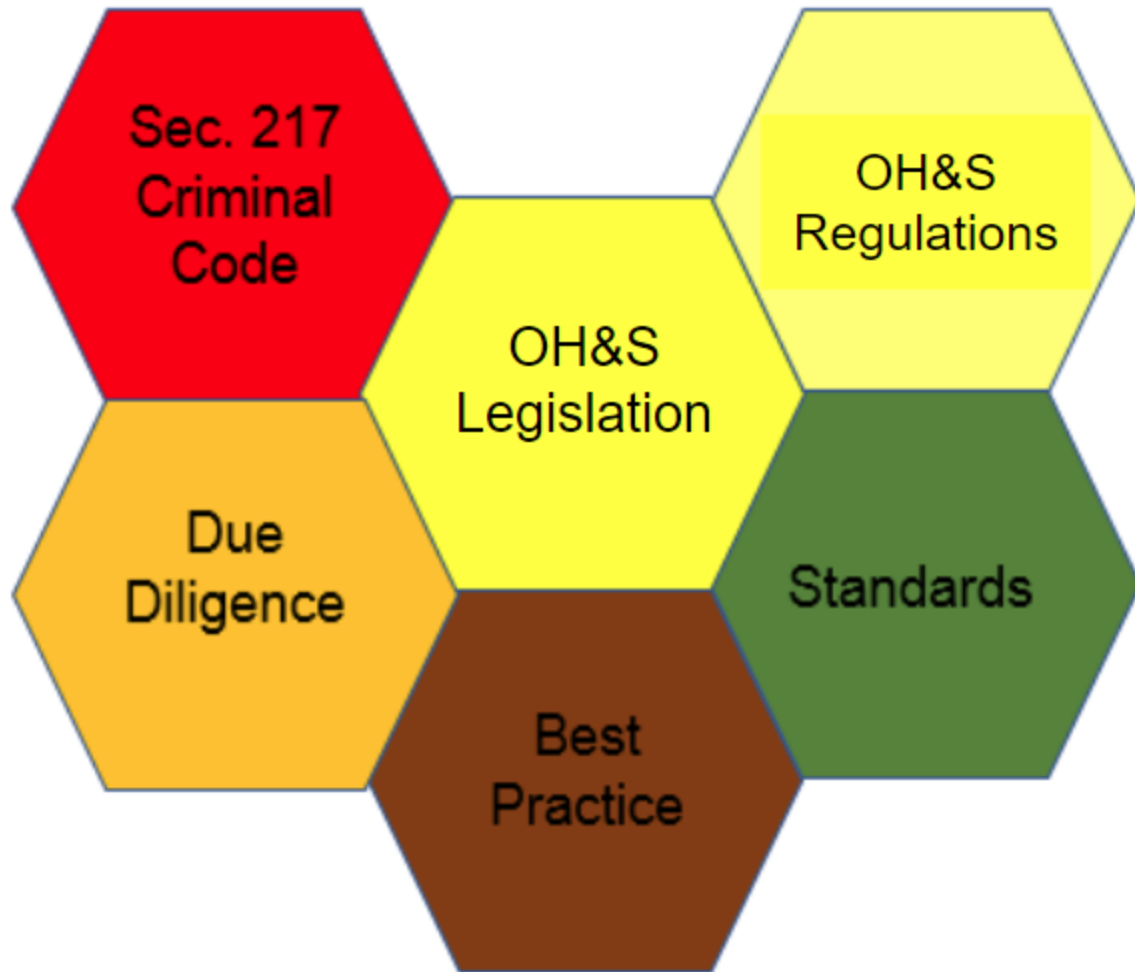

The Bottom Line

Employers and workers must ensure they understand under which authority they are working and be familiar with the legislation, regulations and standards they must follow.

Chapter 1 Summary:

What was covered in Chapter 1?

- The relationship between Legislation, Regulations, Standards, Due Diligence, and Best Practices.

CHAPTER 2: ENSURING A SAFE WORKSITE

Goal:

The student should understand the roles and responsibilities of employers and employees and workplace programs as they relate to the operation of lift trucks.

Objectives:

1. The student should be aware of employers' responsibilities as they relate to the operation of lift trucks.
2. The student should be aware of employees' responsibilities as they relate to the operation of lift trucks.
3. The student should be aware of the key elements of a health and safety program for lift truck operators.
4. The student should be aware of requirements of an Emergency Response Plan.
5. The student should be aware of management, and supervision responsibilities as they relate to the operation of lift trucks.
6. The student should understand competency requirements as they relate to the operation of lift trucks.
7. The student should be aware of the elements of proper job planning and hazard assessment as they relate to the operation of lift trucks.
8. Facility Design; students should be aware of workplace requirements.

Manitoba Legislation and Regulations

Click on this link, [Manitoba Safety and Health Act and Regulation](#), and thoroughly review the following sections of the Act:

- Duties of employers.
- Duties of Supervisors
- Duties of Workers
- Any other section that may apply to you at your work site.

Click on this link, [Manitoba Safety and Health Act and Regulation](#), and thoroughly review the following sections of the regulations:

- Part 16 MACHINES, TOOLS AND ROBOTS
- Part 22 POWERED MOBILE EQUIPMENT
- Any other section that may apply to you at your work site.

Manitoba Lift Truck Certification Requirements

- Employer to Ensure Competency of Powered Lift Truck Operators
- Even though training can be acquired from outside agencies, employers must ensure employees are competent in their work environment with the equipment they must use and issue a certificate indicating this. Once certificates are issued, the employer must develop an evaluation system to ensure ongoing competency of operators.
- This shall include, but not be limited to:
 - testing on operation of the powered lift truck.
 - knowledge and skill level regarding the lift truck
 - company policy and procedure relating to its operation.

This evaluation will assess the need for further training, updates or refresher courses. This training shall be documented and be made available to a safety and health officer of the Workplace Safety and Health Division whenever requested.

All operator training and evaluation shall be conducted by persons who have the knowledge, training and experience to train powered industrial truck operators and evaluate their competence.

Information to be included on the certificate:

- company name (and name of training agency, if applicable)
- employee name
- date of issue
- type of equipment certified to use
- signature of employer and instructor

Lift truck operators must follow this code of practice:

Click on this link, [Manitoba Code of Practice: For the Safe Operation of Powered Lift Trucks](#), and thoroughly review this code of practice

Employer Responsibilities

- The primary purpose of OH&S laws is to keep workers safe. Under OH&S laws, employers are ultimately responsible for all persons on their worksite.
- Employers must develop safety policies and procedures for its workers.
- Employers must follow all requirements of the authorities having jurisdiction..

Employee Responsibilities

- Employees must, while at work, make all reasonable efforts to ensure the safety of all persons at the worksite, including other workers, traffic and pedestrians.
- Employees must follow all requirements of the authorities having jurisdiction.

Chapter 2, Slide 14 – Lift truck incident video.

An Organized Approach:

- An organized approach through a company Health and Safety Management System is necessary to ensure all roles, responsibilities, and program requirements are met or exceeded.

The next sections of this course are based upon the key elements of a Health and Safety Management System.

Elements of a Health and Safety Program for equipment operators:

- Training, Information and Auditing.
- Management, Supervision and Internal Responsibility.
- Job Planning and Hazard Assessments.
- Safe Operating Procedures.
- Prevention of Injuries.
- Equipment Maintenance and Modifications.
- Facility Design.
- Additional safety training may include First Aid, WHMIS, Transportation of Dangerous Goods, Spill Containment, Ground Disturbance, Fire Safety, etc.

Further requirements the employer must comply with:

- Specifications and Certifications (for equipment).
- Chemical Hazards, Biological Hazards and Harmful Substances.
- General Safety Precautions i.e. securing equipment and materials.
- Lifting and Handling Loads.
- Mobile Equipment.
- Fork-mounted work platforms.
- All applicable codes of practice.

Training and Information

- Although it is the employers' responsibility for the provision of training, employees are responsible to use that knowledge and participate in any company procedures regarding the safe operation of their equipment.
- Remember, no one can make you a safe operator. That is a choice that you make every time you operate equipment.

Familiarization Training

- Before being authorized to operate a particular lift truck make or model, the operator should receive familiarization by a qualified person in:
 - The location of the manufacturer's manuals on the lift truck.
 - The manufacturer's specific warnings and instructions.
 - The control functions specific to the particular lift truck.
 - The function of each safety feature specific to the particular lift truck.
 - The operating characteristics specific to the particular lift truck.

Operators Basic Safety Practices:

- Always use the operator restraint system.
- Operate the equipment from the operator's compartment only.
- Use the equipment for its intended purposes only.
- Obey safe operating policies.
- Maintain a clear path of travel.
- Travel in reverse if forward vision is blocked or use spotters if they are available.
- Notify your supervisor immediately if you are involved in an incident which results in personal injury or damage to the equipment.

Emergency Actions

- An employer must establish an emergency plan for responding to emergencies at the workplace.
- The plan should be known and understood by all employees and trained so that they can react appropriately to the incident.

The Emergency Response Plan (ERP) should include:

- The identification of potential emergencies;
- Procedures for dealing with identified emergencies;
- The identification, location, and use of emergency equipment;
- The emergency response training requirements;
- The location and use of emergency facilities;
- The fire protection requirements;
- The alarm and emergency communication requirements;
- The first aid services required;
- Procedures for rescue and evacuation;
- The designated rescue and evacuation workers;
- Training should also include understanding the procedures to follow in the event of an incident involving dangerous goods or controlled products.

Job Planning

- Every worker should attend daily crew meetings (i.e. tail-gate, toolbox) at the beginning of their shift.
- The purpose of the tail-gate meeting is to discuss and plan the work assignments for the day, and complete necessary documentation.
- It also allows workers an opportunity to ask questions regarding their assigned tasks.
- It is critical that all affected workers participate and contribute to the discussions at these planning sessions.
- Taking the time to plan the job will save time and money, “Failing to plan is planning to fail”.
- It is the worker’s responsibility to ensure that they have a clear understanding of assigned tasks including any hazards associated with the task.
- Look at the ‘Big Picture’, discuss the over-all project and your role within it.
- Note power lines, temporary roads, traffic patterns, pedestrian paths, material storage, equipment lay-down areas, and where other equipment is working.
- Consider how your task may affect others, if others could be impacted by your assigned task discuss the issues with them and/or their foreman/supervisor.
- What other vehicles, mobile plant or work equipment could be close by?
- Look at where the other trades will be working later that day, week or month.
- Decide where you will work, where you will pile, load and place materials.
- Walk the jobsite; look for outbuildings, racks, and other obstructions that could interfere with your ability to operate safely.
- Before you dig have marked underground services prior to disturbing the ground.
- Determine what equipment, tools and materials your task will require, and select proper equipment, material and tools.
- Ensure there are no conflicts with others’ tasks; if there are, alert your supervisor/foreman, so alternate arrangements can be made.
- If transporting the equipment, determine whether a pilot vehicle(s) will be required and, if so, arrange for such.

Operator's Manual

- Mobile Equipment operators must be familiar with the operator's manual for the specific equipment they operate.
- The information is vital for safe operation of the Mobile Equipment and outlines the equipment's safety concerns, safe operation and the equipment's maintenance requirements.
- Each piece of equipment must have a manual available for it, if it doesn't then report this to your supervisor and order a new one.
- Read and follow the operators' manual.
- Observe all warning plates and decals on the equipment and in the operators' manual.
- The operator's manuals will explain any potential safety hazards whenever necessary in special messages that are identified with the word **DANGER**, **WARNING**, or **CAUTION**, and the safety alert symbol.
- Memorize the meaning of the following boldface terms appearing in warnings in both the equipment manuals and on the equipment itself.



Danger! Indicates a high probability of death or serious injury and/or serious equipment damage if the hazard is not avoided.



Warning! Indicates a potentially dangerous situation that could cause injury or death and/or serious equipment damage if the hazard is not avoided.



Caution! Indicates hazards that could result in minor or moderate injury or damage to the equipment.

Refer to the operator's manual for the following information:

- Main components of Mobile Equipment.
- Basic specifications.
- Safety and security.
- Operator's cab.
- Operating the machine.
- Maintenance.

See if you can find the above information in this on-line manual:

FC Lift Truck

<https://www.crown.com/content/dam/crown/pdfs/en-us/operator-manuals/counterbalance-trucks/counterbalance-fc5200-opman-en-us.pdf>

Know your lift truck

- Read and understand the Operator's Manual before using the equipment; if the manual is not on the machine – get one!
- Read, understand and follow the Danger, Warning, Caution and other safety signs on your equipment.
- Know the rated capacity, speed range, braking and steering characteristics, turning radius, and operating clearances.
- Know the purpose of all the controls, gauges, and dials.
- Know where fire extinguishers, first-aid, and emergency equipment are kept and where to get help if needed.
- Know the weight of your loads and do not, at any time, exceed the rated capacity of the machine.
- Make sure your equipment is ready for the job it must do; ensure equipment has been examined, inspected, maintained and daily checks completed.

Hazard Assessment

- Hazard assessments need to be conducted as required by the authorities having jurisdiction.
- To identify existing or potential hazards before work begins, at regular intervals and when anything changes that could affect the safety of the worksite.
- Equipment operators and supervisors should be involved in the hazard assessment process.
- Each job site has its own unique operating hazards and site considerations.
- Every equipment operator should take the time to assess every job site every time work begins for the day, shifts to a new location, or when a new job on the same site commences.
- Once a hazard has been identified, a worker is required to follow safe work procedures to avoid causing damage or injury at the worksite.

Participate and Contribute to Discussions:

- Ask questions of task assignment and how your job fits in with overall job.
- Discuss your role with supervisor/foreman and co-workers.
- Develop a work plan that accounts for others' tasks and reduces or eliminates risks to others that could be created by your task's hazards.
- Assess and discuss specific task and/or site hazards; introduce new information as needed.

Consider the impact of worksite hazards such as:

- Slopes and inclines
- Ground conditions
- Moisture
- Soil stability
- Debris
- Loose gravel
- Vehicle and Pedestrian Traffic
- Other people and equipment working in the area
- Other Mobile Equipment
- Animals
- Fog or mist near lakes and ponds

Be alert for changes that may impact your task or those of your co-workers.; if any significant changes are noted, inform your co-workers.

Check the Work Area

- Check the ground or floor over which you will travel and work. Look for obstructions, holes, debris, obstacles, drop offs or rough spots.
- Weak spots or covers on ramps and floors.
- Oil spills, wet spots, slippery surfaces, soft soil and standing water.
- Soft, uneven surfaces or anything that might make you lose control or cause you to tip over.
- Assess weather conditions.
- If working outdoors, a detailed weather forecast should be accessed each morning. It is critical that weather is discussed during the planning sessions.
- Be prepared to adjust tasks, people and/or equipment if weather changes. If a weather change is expected, discuss the potential impact with the crew.
- Rain, snow, ice, etc., can change the operating characteristics and capabilities of your equipment and require extra caution during operation.

Facility Design & Workplace Requirements

- Workplaces facilities must be designed to operate equipment safely.

The equipment operator should:

- Ensure there are adequate overhead clearances.
- Ensure that alleyways, and yards have adequate spacing to permit the safe operation of the equipment while engaged in work.
- Designated walkways, barriers, warning signs and other safeguards should be utilized to prevent the occurrence of a collision between a person and equipment.
- In the absence of designated walkways, safe work procedures must be in place for pedestrians walking near operating equipment.
- Watch for ponds that have steam rising obscuring visibility in the field.
- Be aware of wet conditions that could lead to uneven and soft ground.
- Ventilation must be adequate to remove toxic gases created using internal combustion engines while indoors.
- Workplace design should identify walkways for pedestrians and workers not engaged in equipment operation.
- Floors, aisles and passageways should be kept clear of debris and other potential hazards.
- Racks and other storage units should be of adequate strength to ensure they can safely store the intended loads.

Safe Work Zone

- The creation of safe work zones for the equipment being used is an important aspect of keeping other workers and people safe.
- The safe work zone is typically calculated at 1.5 times the over-all length of the equipment extending completely around the furthest outside edge of the equipment.



The above image represents the machines safe operating zone. This concept would be applied to any Mobile Equipment as a company policy.

Chapter 2 Summary:

What was covered in Chapter 2?

- Employers' responsibilities as they relate to the operation of lift trucks.
- Employees' responsibilities as they relate to the operation of lift trucks.
- Key elements of a health and safety program for lift truck operators.
- Requirements of an Emergency Response Plan.
- Management, and supervision responsibilities as they relate to the operation of lift trucks.
- Competency requirements as they relate to the operation of lift trucks.
- Elements of proper job planning, and hazard assessment related to the operation of lift trucks.



CHAPTER 3: INSPECTIONS AND MAINTENANCE

Goal:

The student should understand the importance of Mobile Equipment inspections and how to conduct the inspections safely.

Objectives:

1. The student should be aware of the requirements of a visual inspection of lift trucks and how to perform the inspection safely.
2. The student should be aware of the requirements of an operational inspection of lift trucks and how to perform the inspection safely.
3. The student should be familiar with generic inspection checklist.
4. The student should be aware of actions to be taken when a defect on a lift truck has been identified.
5. The student should be aware of the requirements in making modifications to lift trucks.

Lift Truck Inspection

The following are general guidelines to follow while completing an inspection.

- Inspections are usually part of a company policy; this ensures the employer that equipment is inspected on a regular basis.
- Equipment operators must ensure that their machine is in safe operating condition.
- Always follow the equipment manufacturer's inspection requirements. These inspections reveal necessary equipment repairs or replacements.
- Operators need to be able to recognize and record equipment problems and report unsafe equipment to the employer immediately.
- In addition to the equipment and attachments to be operated, inspections could also include damaged racking, dock-boards, loading ramps, straps, chains and cables and other equipment.
- The pre-operation inspection is a visual inspection performed by the operator prior to each work shift.
- The inspection is designed to discover if anything is apparently wrong with a machine before the operator performs the function tests.
- It is critical that a walk-around inspection be done to check for obvious mechanical problems, equipment clearances, closeness to other equipment or structures and other workers who may be at risk when the equipment is moved.
- If necessary, a lift truck operator may be required to perform pre, mid, and post operational inspections.
- The operator's manual outlines the frequency of inspections and maintenance for equipment.
- Be sure that the operator' safety and responsibilities manuals are complete, legible and in the storage-container located on the equipment.



Danger!

A worker should never operate equipment or an attachment that is damaged and needing repair.

Inspections may include but are not limited to:

- Check the function of alarms, warning lights and other lights.
- Top up fluids, grease the machine, and keep it clean.
- Look around the machine for loose bolts, trash build up, oil or coolant leaks, and broken or worn parts.
- Inspect the condition of the attachments and the hydraulic components.
- It is not expected that the equipment operator performs mechanical duties such as changing oil, changing fan belts, or making repairs etc.

Checklists

- Checklists must be based upon the requirements of the manufacturer; some equipment manuals include checklists that can be photocopied.

Checklists should be used by the operator to:

- Ensure that a proper inspection of their equipment is completed.
- Provide documentation that the inspection was completed as required.

Key Elements of an Inspection Checklist:

- | | |
|--|---|
| • Date & time when the inspection was performed. | • Incidents that may affect the operation of the equipment. |
| • Repairs and modifications performed. | • Number of hours operated. |
| • Inspections performed. | • Certification records. |
| | • Records the person doing the work. |



Warning!

Do not walk underneath any suspended attachments unless they are mechanically supported and secure.

Check List Example

On approach to the vehicle:

ITEM	DESCRIPTION	Yes	No
	Look around the equipment for obstructions, debris, other equipment and people.		
	Look for vehicle traffic and other equipment in the area.		
	Check that equipment is sitting level, on level ground.		
	Look for fluid underneath the machine and its attachments.		

At the vehicle, with the key in the "OFF" position, check for:

ITEM	DESCRIPTION	Yes	No
Exterior	Check body, safety guards for damage		
The equipment attachments and locking devices	Check condition, defective parts		
Mast or main lifting arm assembly	Check condition, defective parts		
Pins and bushings	Check condition		
Windows	Check cleanliness, wiper fluid level		
Mirrors	Check cleanliness and adjustment		
Tires	Check pressure and wear		
Wheel bolt studs	Check tightness		
Coolant	Check level		
Fuel	Check level		
Engine oil	Check level		
Air cleaner	Un-obstructed		
Seals	Leaks at oil, water and hydraulic lines		
Hydraulic cylinders, hoses and fluid	Leaks, and level		

Transmission fluid	Check level		
Battery	Check electrolyte level and terminals		
Air ventilation filter	Clean		
Fuel pre-filter	Drain water		
Air intake hoses	Check connections		
Fire Extinguisher	Present, secure, and charged		
First aid kit	Present, secure, and stocked		

With the key in the “ON” position, check for:

ITEM	DESCRIPTION	Yes	No
Instrument gauges	Functioning normally		
Operating, running, signal and emergency lights	Clean, operating and adjusted		
Warning devices and alarms	Good working order		

Starting the Engine

Once you have performed all pre-operational procedures, you are ready to start the machine and test all functions. Before you start the engine:

- Look completely around the equipment before attempting start-up.
- Adjust the operator seat and secure seat belt.
- Ensure all controls are in neutral.

With the engine running, check for:

ITEM	DESCRIPTION	Yes	No
Instrument Gauges	Warning alarms and lights are off		
RPM indicator and hour meter	Are working normally		
Fuel gauge	Level		
Drive forward and reverse	Working normally		
Steering	Working normally		
Service and park brake	Working normally		
Load handling devices	Working normally		
Odours, sounds, feel	Unusual or suspicious		
Safety interlock system	Working normally		
Foot pedal movement	Brake and throttle pedals are smooth		
Comments			
Supervisor's receipt:			
Operator signature:		Date:	
Vehicle Identification:		Hour Meter:	

PERIODIC MAINTENANCE SCHEDULE				
ITEM	EVERY 10 HOURS	DESCRIPTION	Yes	No
Check tire pressure and wear				
Drain water from air tank				
Inspect engine belts				
ITEM	EVERY 50 HOURS	DESCRIPTION	Yes	No
Fasten the connecting bolts on the front & rear drive shafts				
Check oil level in the brake booster pump				
Check and lubricate throttle control, parking brake and transmission control system				
Grease fan shaft, articulation points, drive shaft, and oscillating suspension				
Comments				
Operator signature:				
Supervisor's receipt:				

Ensure generic Mobile Equipment checklists include the requirements of the equipment manufacturer

Inspection Deficiencies

If you find deficiencies while performing the operational inspection, determine whether the problem affects the safe operation of the equipment or not.

If the problem affects the safe operation of the equipment,

- Fit the machine with a “DO NOT OPERATE” tag. Follow company lock-out policy.
- Submit your operational inspection report to your supervisor for follow-up.

Otherwise, continue working but ensure the necessary repairs are carried out before the problem does have an effect on the safe operation of the equipment.

Many mechanical conditions or design features increase the risk for Mobile Equipment incidents, below is a list of the more common areas of concern.

- Malfunction of brakes.
- Malfunction of steering.
- Malfunction of clutch, shift linkage, or transmission.
- Malfunction of attachment assembly.
- Emissions from equipment.
- "Blind spots" or obstructions blocking driver's view.
- Poor layout of controls and displays.



Caution!

Lock-out and tag-out unsafe equipment to prevent further use.
Do not operate the machine until deficiencies are corrected and all systems are in good operational condition.

Lock-out / Tag-out Procedures

Lock-out / Tag-out procedures are used to ensure that any unsafe equipment is rendered inoperative until such time that it is repaired to the manufacturer's safe operation specifications.



Caution!

Lock-out of equipment may require multiple steps.

Equipment Integrity

- Operating capacities are determined by certified engineers on behalf of the equipment manufacturer.
- Due to the wear and tear that occurs to the equipment under normal operating conditions it is expected that, over time the equipment will deteriorate with use and therefore the equipment's capacity could decrease as well.
- Companies who follow the maintenance and service requirements of the equipment including Non-Destructive Testing can reasonably expect that the equipment will remain in good operating condition.
- This also gives the operator the confidence to operate the equipment to its capacity knowing that they have a reliable piece of equipment.
- It is the employer's responsibility to maintain equipment in accordance with the operator's manual.
- It is the operator's responsibility to inspect and help maintain the equipment they work with.
- If the equipment is not inspected and maintained according to the manufacturer's requirements as outlined in the operator's manual and an incident occurs, the liability may lay primarily with the employer, but also with the operator.

Housekeeping

- Housekeeping is essential to preventing problems.
- The purpose of housekeeping is to keep the equipment clean and free of debris and loose objects that could cause problems.
- Before attempting to clean a machine, be sure to wear personal protection equipment as required, lower attachments and turn off the engine.
- Remember to blow down or wash the equipment regularly.
- It is the equipment operator's responsibility to ensure that the equipment they are operating is cleaned and ready for the next operator and/or next shift.
- Clean steps, railings, ladders, and floor.
- Remove grease or oil. Brush away dust or mud. In the winter, scrape away snow and ice.
- Replace slip-resistant tape or paint, as required.
- Keep the cab clean & free of loose objects and debris.
- Remove or put away tools, ropes, and hooks. Remember-loose items on the floor could cause an accident.
- Maintain the fire suppression system.

Maintenance

- Regular equipment maintenance is an essential element of any safety program.
- Only routine maintenance items specified in the manufacturer's manual may be performed by the operator.
- Repairs to the equipment must be made by a qualified service technician, according to the manufacturer's specifications.
- After repairs are completed, the operator must perform a pre-operation inspection again before going on to the function tests.

Modifications

- An employer must ensure that any modification, welding, or cutting of a rollover protective structure or a falling object protective structure is done in accordance with the manufacturer's instructions and is re-certified as restored to its original performance requirements by, the equipment manufacturer or a professional engineer.

Chapter 3 Summary

What was Covered in Chapter 3?

- Requirements of a visual inspection of lift trucks and how to perform the inspection safely.
- Requirements of an operational inspection of lift trucks and how to perform the inspection safely.
- Importance of using checklists when performing inspections.
- The actions to be taken when a defect on lift trucks has been identified.
- Requirements for making modifications to lift trucks.

CHAPTER 4: SAFE OPERATION OF LIFT TRUCKS

Goal:

The student should be familiar with the requirements for the safe operation of lift trucks

Objectives:

1. The student should be familiar with General Operation procedures for lift trucks.
2. The student should be aware of the importance of being proficient with specific safe operation procedures of the Mobile Equipment they operate.
3. The student should be aware of the importance of mounting and dismounting equipment in a safe manner and using seat belts and wearing appropriate Personal Protective Equipment (PPE).
4. The student should be aware of the importance of following proper start-up and shutdown procedures for lift trucks.
5. The student should be familiar with communications procedures while operating lift trucks.
6. The student should be familiar with essential qualities and rules for lift truck operators.
7. The student should be familiar with procedures for the safe movement, load handling and re-fuelling of lift trucks.
8. The student should be aware of conditions that can affect the safe operation of lift trucks.
9. The student should be aware of special hazards related to lift trucks.
10. The student should be aware of procedures for the safe transportation of lift trucks.

General Operation

- Never operate equipment that is not working properly. If a malfunction occurs, shut it down.
- Never slam a control switch or lever through neutral to an opposite position.
- Always return switch to neutral and stop before moving the switch to the next function.
- Operate controls with slow and even pressure.
- Hydraulic cylinders, other than the outrigger cylinders, should never be left at end of travel (fully extended or fully retracted) before shutdown or for long periods of time.
- Always 'bump' control in opposite direction slightly when function reaches end of travel, this applies to both equipment in operation and in the stowed position.
- Never use the equipment to push or pull another vehicle except as approved by the manufacturer.

Machine Specific Safe Operation

- The equipment operator's manual contains instructions for the model of equipment that you will be operating.
- It is important that you take the time to read the manual and understand the controls and functions of the specific machine that you will be operating.
- It is the operator's responsibility to follow all the safety rules and instructions in the operator's manual.
- Using the equipment for anything other than what it was intended to do is unsafe and dangerous.

Basic Safety Rules

- The only safe place to operate equipment is from the operator's station. Only operate the controls while driving from within the confines of the cab.
- Take care climbing into/onto the equipment. Squarely face the vehicle and use the three-point contact method for mounting and dismounting; two feet and a hand or two hands and one foot.
- Never use equipment controls as handholds when mounting or dismounting. Because of the play in the levers, you could lose your balance and slip or cause the equipment to move.
- Observe proper shutdown practices before dismounting.
- Never dismount from a moving machine.
- Before dismounting the equipment, make sure the attachment is firmly on the ground, the vehicle is in neutral, and the parking brake is on.
- Be sure hands and feet are free of excess debris, grease and oil.
- Use extra care when mud, snow, or moisture present slippery conditions.
- Keep steps clean and free of grease and oil.
- Use handrails, ladders or steps (as provided) when mounting the machine.
- Never step on foot controls when mounting or climbing off.
- Dismount carefully using three-point contact and face the machine.
- Check for slippery steps.
- Keep your feet and hands away from the controls. Never jump off the machine.

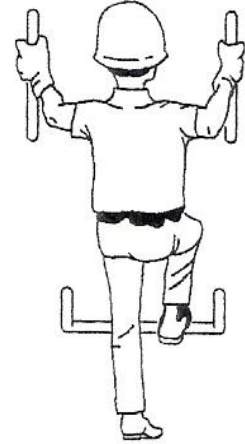

Seat Belts - Without seat belts, you can be thrown from the cab in a roll-over.

- Seat belt use is mandatory with Mobile Equipment equipped with a seat for the operator (Refer to 16.32 of the OH&S Regulations for details).
- Some manufacturers require that nylon seat belts be replaced every three years because they are continually exposed to the deteriorating effects of use, weather, sunlight, oil, and grease.

Basic Operating Procedures

- Starting - Before starting, walk completely around the equipment, make sure no one is under it, on it or close to it.
- Follow the starting procedures recommended by the manufacturer of your equipment. Check all instruments, gauges and indicator lights.
- Check for instructions in the operator's manual for cold weather starting.
- **WARNING:** Starting fluids are highly flammable.
- Ensure you can control machine functions, speed and direction before moving.
- Should something break, loosen or malfunction on your machine, stop work, shut off the engine and seek qualified assistance to correct the condition.
- Do not operate the machine until the condition has been corrected by authorized personnel.
- **WARNING:** Exhaust fumes can kill.

Additional Information:

- Let other workers and bystanders know you are starting up and don't start until everyone is clear of the machine.
- Follow the manufacturer's instructions for use of starting fluids, don't carry loose cans of starting fluid in the machine.
- When starting your equipment in an enclosed space, make sure there is enough ventilation.
- Do not start or drive the equipment into confined areas such as refineries where flammable gases may be present.
- Check with plant safety personnel before entering any questionable area.
- After starting, recheck all gauges and lights.
- Check the audible and/or visual alarms (if provided).
- If the equipment does not respond correctly when each control is operated, do not use the machine until it is fixed.
- Move slowly until you are certain everything is operating properly.
- Recheck the steering, right and left.
- Be certain you have full travel and automatic brake control.
- Be certain you can lower attachments.
- Safe shutdown procedures - Correct shutdown is important to safe operation, refer to your manufacturer's manuals.

Generic Steps:

- Park Safely
- When parking or leaving the equipment for any reason,
- Park your machine in a designated area or out-of-traffic and only on level ground.
- Come to a full stop.
- Place and lock controls in neutral.
- Engage the parking brake.
- Lower or secure all attachments.
- Idle engine for gradual cooling.
- Block the wheels.
- Shut off engine or electrical power.
- Take necessary steps to prevent unauthorized use in accordance with the operator's manual.

Communications

- Companies are required to have a policy regarding communication amongst workers on the job site.
- The communication system can include the use of radios, hand signals, lighting signals, audible signals, and so on.
- In some cases, companies use spotters to guide equipment operators.
- It is the operators' responsibility to ensure effective communication protocols are in place for all workers near operating equipment.
- A communication system must be developed and understood where spotters/signalers are used.
- Radio communication and hand signals must be discussed and fully understood amongst all workers that will be utilizing them.
- Always keep signal person in view

Generic Hand Signals:

PROCEED SLOWLY

FORWARD



Always face palms in direction of desired travel.

BACKWARD



Then bend both arms repeatedly toward head and chest, and then extend.

← TURNS →



Point one arm to indicate the direction to turn.



Bend monitoring arm repeatedly toward head to indicate continued turning.

DISTANCE TO STOPPING POINT



Face palms forward, with hands above head. Bring elbows forward and hands together.

STOP

Cross both arms above head.



Moving the Attachment



Extend Boom



Retract Boom



Swing



D&G (Stop) Everything



Raise Boom



Lower Boom



Hoist



Lower



Stop



**Move Slowly
(eg. Hoist Slowly)**

Essential Qualities of an Equipment Operator

Knowledge

- Understanding of the sections of the Workplace Safety and Health Act and regulations applicable to the work.
- The hazards associated with the work
- The principles of operation and features of the lift truck.
- The workplace conditions and environment.
- Which workplace activities pose actual or potential danger to health and safety.
- The manufacturer's specifications related to the operation and safe load handling for the classes or types of trucks operated
- The procedures and practices for ensuring worker safety that are specific to the workplace.
- Company rules and safe operating procedures.
- Emergency procedures.
- Momentum, leverage, and stability principles, and capacity as well as the forces affecting the equipment and its loads stability.

Skills

- A competent operator must be able to perform the following procedures in a manner consistent with the competence standards using the assigned vehicle under typical workplace conditions:
- Pre-operational check.
- Start-up and shut-down.
- General operation – stopping, starting, turning, driving forward and in reverse with or without a load, parking, operating around personnel.
- Load handling – selection and security of loads, pick-up and placement, personnel lifting, stacking and unstacking, handling specific to docks, trucks or rail cars.
- Loading and unloading – transport vehicles, structures, elevators.
- Operational maintenance – refuelling or recharging as appropriate.
- Operating experience and knowledge of the equipment they operate.
- Good decision-making ability when judging operating conditions.
- The proper selection, security and integrity of various loads.
- Proper and safe refueling and recharging practices.

Good Attitude

- A safety-first philosophy.
- No need to prove himself or to show off.
- Not being pushed beyond safe limits by production schedules or peers.
- Exercising self-control.
- Being cooperative, courteous and considerate of others.

Physical Qualities

- Good reflexes and coordination.
- Good vision and depth perception.
- Good physical conditioning.
- Quick thinking.

Rules for lift trucks operators

- Know the equipment's lifting capacities and never exceed them.
- No passengers are allowed on the equipment.
- Never allow anyone to walk or stand under an elevated load.
- An operator must not leave the controls of the equipment unattended unless it is secured against unintentional movement.
- Operate only on solid footing with strength sufficient to support the machine, be especially alert working near embankments, excavations and on slopes.
- Never drive your equipment up to someone standing in front of a fixed object.
- Limit the height of the attachment and any load as much as possible while travelling, especially on side slopes or an unstable surface.

New employees must receive an orientation on the specific equipment at the workplace and be trained or evaluated on the specific equipment prior to operating it.

- Always operate the equipment in a safe and courteous manner with absolutely no stunt driving or horseplay.
- Ensure there are adequate clearances for the work in progress.
- Workers must operate the equipment safely, which includes watching for moving parts that may endanger a worker.
- Prepare the work site properly, avoid operating near structures or objects that could fall onto the equipment.
- Avoid working under over-hanging embankments or stockpiles that could collapse under or on the equipment.
- Make certain everyone is clear of the machine before you begin lowering a load.
- Maintain a clear path of travel.
- Avoid sudden stops, starts, turns or changes in direction.

Never alter, remove or substitute any item which could reduce the overall weight or base stability of your machine; such as counterweights, foam filled tires, batteries, etc. unless authorized by the manufacturer.

Special Hazards:

- Battery Hazards

Charge batteries only in a well-ventilated area.

Refer to manufacturer's manuals for charging procedure.

Warning Lead-acid batteries produce flammable and explosive gases.

Never allow smoking, flames or sparks around batteries.

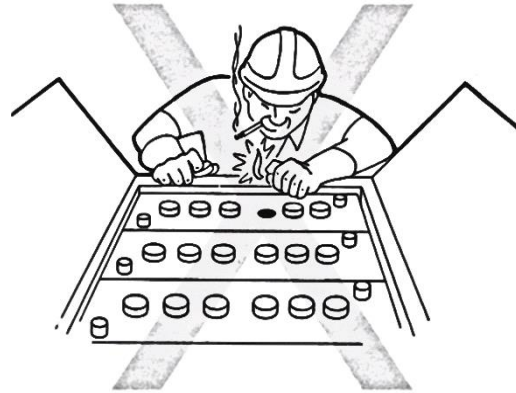

- Crossing Railway Tracks

Ensure load is secure.

Watch for railroad traffic anytime you are working on or near tracks.

Use regular track crossings whenever possible or risk damaging the tracks.

Ensure permission to cross tracks has been given by track operator.

Greasy or slippery tires can make travel over tracks more difficult.

Tracks may cut tires.

Never park closer than 8 feet to center of railway tracks.

- Ground Obstructions

Always watch for ground obstructions that affect vehicle stability.

For smooth terrain keep the attachment 4-6 inches above the ground, for rough terrain keep the attachment 12–16 inches above the ground.

If obstacles must be crossed, slow to a safe speed and raise the attachment further to avoid contact with the object.

Be alert; the machine could side spin at any time as you move over a large obstacle.

Hydraulic Oil Injection Injury

Hydraulic injection injury is the term used to describe an injury sustained by an individual following an injection of fluid, usually while operating or inspecting pressurized hydraulic equipment.

Pressurized fluid such as those found in hydraulic application can travel at the speed of a bullet and penetrate all known levels of PPE.

Skin penetration can occur at pressures as low as 100psi and from 4 inches to the source.

Prevention

- Maintain 12" distance from sources.

- Use a barrier.

- Ensure all hoses are protected from chafing.

- Inspect components on routine basis.

- Replace (never repair) worn hoses or components.

- Wear all recommended PPE when working with on or around hydraulic systems or components.

Treatment

- Hydraulic oil injection injuries can be fatal, seek medical attention immediately.

- Load Handling

Movement of loads shall be conducted in such a manner to ensure the safety of all workers and pedestrians near the operation.

If there exists, the potential for a suspended load to shift, barricades must be put in place to reduce a person's exposure to the danger of falling objects.

Any load which may tip, fall or endanger a person must be secured.

Only properly approved work platforms may be used to support, raise or lower workers.

Travel restraint should be worn by the persons in the work platform.

Stacked pallets of materials must be stable and not easily moved or knocked over.

Prior to lifting a load, the load weight information should be provided to the operator for review.

If the load to be moved is unsafe, the operator must refuse to move the load until their concerns can be appropriately addressed.

- Moving Pipe

Use a pipe grapple attachment.

Could insert forks into end of pipes.

Be sure weight is within rated load capacity.

Be careful when inserting forks into pipes. Don't damage pipe or forks.

Consider principles of leverage when load center extends beyond normal.

- Mud and Wet Conditions

Wet conditions cause sideways slippage of the machine on any slope.

Consider chaining the wheels – front and back.

Feather the controls; avoid sudden starts and stops as machine will slide.

Keep wheels cleaned. Mud will build up inside wheels and then harden around valve stems causing the valve stems to break or become unseated.

Keep inside of tracks clean. Excess material will cause excess wear and tear, or possible cause a track to slip off.

- Overhead Power Lines (OHPL)
- Accidental contact with live overhead power lines kills people and causes many serious injuries every year.
- People are also harmed when a person or object gets too close to a line
- Workers must follow the employer's directions to maintain the appropriate safe clearance distance.

The following is an example of safe limit approach distances for persons and equipment. Employers and employees are responsible to ensure the requirements of the authorities having jurisdiction are met.

Operating voltage between conductors of overhead power line	Safe limit of approach distance for persons and equipment
0-750 volts Insulated or polyethylene covered conductors (1)	300 millimetres
0-750 volts Bare, uninsulated	1.0 metre
Above 750 volts Insulated conductors (1) (2)	1.0 metre
750 volts-40 kilovolts	3.0 metres
69 kilovolts, 72 kilovolts	3.5 metres
138 kilovolts, 144 kilovolts	4.0 metres
230 kilovolts, 260 kilovolts	5.0 metres
500 kilovolts	7.0 metres

Chapter 4, Slide 28 – Overhead Power Line Incident Video

- Ensure the safe limit of approach distance is maintained and that no work is done, and no equipment is operated at distances less than the established safe limit of approach distances.
- Safe limit approach distances vary from one jurisdiction to another, it is the employers' responsibility to verify the requirements of the jurisdiction within which they are operating.

Employers should notify the operator of an energized overhead power line before work is done or equipment is operated in the vicinity of the power line at distances less than the safe limit of approach distances and obtain the operator's assistance in protecting workers involved.

Employer should ensure that earth or other materials are not placed under or beside an overhead power line if doing so reduces the safe clearance to less than the safe limit of approach distances.

Some employers exceed the required safe approach distances as an extra safety measure.

- Pedestrian Traffic

Give pedestrians the right of way.

Never allow pedestrians to enter the work area.

Signal pedestrians to stop when in the middle of a job.

Pedestrians often take short cuts and back-up alarms are sometimes ignored.

When passing pedestrians, sound horn, establish eye contact and stay clear.

Wave them on only when it is safe for them to pass.

If a pedestrian does enter the immediate work area, lower your attachment to the ground and stop operating.

If the pedestrian gets too close to your machine, shut it off and remove residual energy from hydraulic system.

Use a signal person if moving equipment in congested areas or where visibility is restricted.

Slow down and sound horn at blind corners when working in the yard and maintenance areas.

Check convex mirrors placed at blind corners if available.

Follow normal traffic patterns.

- Re-Fueling Safety
 - Turn off all equipment before refuelling.
 - Lower attachments to the ground to provide an electrical ground in case of accidental sparking.
 - Don't refuel while another machine is starting or running in the area.
 - Wear PPE.
 - Locate firefighting equipment at the re-fueling station. Follow company emergency procedures in the event of a fire.
 - Review location of manual shutoff valves and switches and all emergency shutdown procedures.
 - Use correct type and grade of fuel.
 - Notify proper personnel and follow company requirements in the event of a spill.
 - DO NOT SMOKE!**
- Rough Terrain
 - Go slow – save the machine. It will rattle the machine and break components.
 - Carry less material.
 - If possible, smooth out rough terrain in the area that you will be operating in.
- Speeding
 - Never speed with the machine.
 - High range should only be used when “roading” the vehicle.
 - Keep a safe distance between you and other machines.
 - Always keep your machine under control.
 - Operator control is reduced significantly at high speeds.
 - Hitting an object at high speed could cause loss of steering and control, and significant injury to the operator and damage to the equipment.
- Time pressures.
 - Both supervisors and customers will pressure the operator. You are in control, slow and steady usually wins the race.
 - Ensure your load is secure.
 - Carry the load “Low and Slow”. Keep the center of gravity of the load as low as possible.

- Understand your travel paths.
 - Reverse, forward, obstructions, clearances, ruts, bumps, and traffic patterns should all be given consideration.
 - Fill in ruts.
 - Pad concrete curbs and sidewalks with soil. This will save on tires and the equipment operators back.
 - Build ramps over finished work, temporary lines and pipes.
- Working at Night.
 - Walk around the machine more often.
 - At night, it is more difficult to see fluid leaks.
 - Look for loose parts, leaking components and damage.
 - Walk the jobsite.
 - The area will look different when working under artificial light.
 - Dust will cause more visibility issues at night under artificial light.
 - Look for dips, drop-offs, and marked utilities.
 - Clear away trash and debris pick up anything that might puncture a tire. Make sure aisles, ramps, doorways and passages are clear.

Transporting the Equipment Safely.

- If your equipment is to be transported by trailer or towing, refer to the manufacturer's manual for the procedures to prepare or load the equipment for transport.
- Back onto trailer only after ensuring that the trailer is properly connected to tow vehicle.
- Back onto the trailer and drive forward off it.
- Cap exhaust stack.

"Trailer" must be considered a potentially very hazardous operation.

Note: The machine shipping weight that is listed is the weight of the most common configuration of the machine. If attachments have been installed on your machine, the weight of your machine and the center of gravity of your machine may vary.

Reference: Refer to Operation and Maintenance Manual, "Specifications" for the dimensions and weight of the machine.

When transporting the equipment on a truck or a trailer, the prudent operator must know the overall height of transport vehicle with the equipment on board to avoid contacting overhead obstructions such as bridges, underpasses, electrical power lines and such.

The operator of a truck & trailer combination has care and control of 2 vehicles, the tow vehicle and the trailer.

The trailer presents a far greater potential hazard than the tow vehicle for 2 reasons:

- The trailer can present a very large mass to the world by its cargo capacity.

- The trailer is un-powered; it is controlled through the movement of the tow vehicle.

The connection between tow vehicle and trailer and, therefore, the control of the trailer by the operator, is completely dependent upon the hitch mechanisms.

Failure of this connection presents enormous potential risk of injury or damage to the public, the environment, and of course, the tow vehicle driver.

Considerations for trailering equipment:

- Ensure truck and trailer is registered for the combined weight and can haul the load.

- Place trailer on firm flat surface.

- Block the tires on both the truck and trailer.

- Ensure that the trailer is blocked underneath to prevent it from lifting at the front when the machine is driven onto it.

- Check truck and ramp capacities and grade of any expected inclines.

- Use spotter.

- Position machine so that the weight is slightly ahead of and over top of axles.

- Lower the attachments and apply down pressure.

- Set park brake.

- Shut off machine.

- Know overall height, weight and width.

- After it has cooled down:

 - Use proper tie down procedures.

 - Securely chain all four corners.

 - Tie down any attachments.

 - Use only inspected chain and angle it slightly away from machine.

 - Tie boomer handles down.

Lifting and Tie Down Points for the equipment

Improper lifting or tie-downs can allow the load to shift and cause injury or damage. Install the steering frame lock link before lifting.



Lifting Point - To lift the machine, attach the lifting devices to the lifting points.



Tie Down Point - To tie down the machine, attach the tie-downs to the tie down points.

Use properly rated cables and properly rated slings to lift the machine.



Chapter 4, Slide 30 – Trailering Incident Video

Operator Safety

- People have been injured while operating their equipment with body parts outside the operator's cab.
- Keep all loose clothing and machine parts away from pinch points.
- Keep extremities inside the protective screens.
- Never reach outside of cab.
- Never attempt to operate controls from outside cab.

© Saga Universal Training Corp 2021

Chapter 4 Summary:

What was covered in Chapter 4?

- General Operation procedures for lift trucks.
- Importance of being proficient with specific safe operation procedures of the lift trucks they operate.
- Mounting and dismounting equipment in a safe manner and using seat belts and wearing appropriate Personal Protective Equipment (PPE).
- Importance of following proper start-up and shutdown procedures for lift trucks.
- Essential qualities and rules for lift truck operators.
- Communications procedures while operating lift trucks.
- Procedures for the safe movement, load handling and re-fuelling of lift trucks.
- Special hazards and conditions that can affect the safe operation of lift trucks
- Procedures for the safe transportation of lift trucks.

CHAPTER 5: LIFT TRUCKS

Goal:

The student should be familiar with different types of lift trucks, their basic structural components, basic function, potential hazards while operating Mobile Equipment and how to control those hazards.

Objectives:

1. The student should be aware of common types of lift trucks.
2. The student should be familiar with the basic structural components of lift trucks and how they function.
3. The student should be aware of potential hazards while operating lift trucks and how to control those hazards.

- “Powered Mobile Equipment” as a wheeled or tracked vehicle which is engine or motor powered, together with attached or towed equipment, but not a vehicle operated on fixed rails or tracks.
- Lift trucks are a type of powered mobile equipment.
- The purpose of this section is to introduce some of the more common types of lift trucks and have the operator understand the basics of the equipment including the equipment’s drive, steering modes and turning dynamics, its strike points, its stability shape and centres of gravity, and attachments.
- Lift trucks are intended to lift and carry a load,.
- Manufacturers design the equipment to withstand the forces involved with having to perform their duty.
- The operator needs to understand the limitations for which the machine will operate under.

As the term Powered Mobile Equipment includes equipment that is driven with internal combustion engines, electric motors, or possibly even steam driven or nuclear powered.

The term “mobile” refers to equipment that travels on wheels, tracks, skids or even feet.

The term “equipment” refers to that equipment in the categories of light, medium, and heavy equipment.

There are many manufacturers of equipment with many styles and shapes.

Some are relatively small and designed to operate in restricted areas handling small loads, while others are massive machines intended to work in large open areas handling very heavy loads.

It is most important for equipment operators to understand not only the types of loads the machine is intended to handle, but also to understand the terrain and the operating conditions for which their machine is intended to operate under.

Due to the nature of work being performed using the equipment, associated hazards to the operator as well as those workers working in proximity to the machine exist.

Operators must understand the responsibility they have while operating equipment.

The weight combined with the lack of training that so many operators have, contribute to become one of the most dangerous operations found in workplaces today.

Classes of Lift Trucks

- The International Industrial Truck Association recognizes eight classes of lift trucks.



Class 1 – Electric Motor
Rider Trucks
(Operator Sits)



Class 2 – Electric Motor
Narrow Aisle Trucks
(Operator Stands)

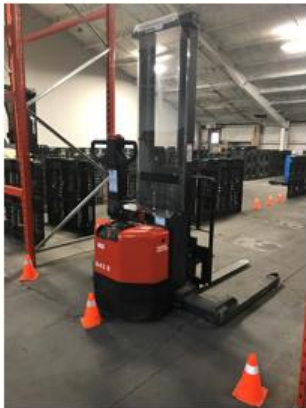

Class 3 – Electric Motor
Hand Trucks
(Operator Stands)



Class 4 – Internal Combustion
Trucks – Cushion Tires Only
(Operator Sits)



Class 5 – Internal Combustion Trucks – Pneumatic Tires Only (Operator Sits)



Class 6 – Electric and Internal Combustion Tow Tractors (Operator Sits)



Class 7 – Rough Terrain Forklift Trucks (Operator Sits)



Class 8 – Personnel and Burden Carriers (Operator Sits or Stands)

The class 8 truck does not lift a load. Examples are golf carts, airport people transporter, some also only carry a load.

- The lift truck is most stable while stopped, level, with load low to the ground and close to the truck.
- Lift trucks contact the ground with at least 3 or 4 “true” points of contact.
- When a lift truck has tandem axles, the centre of the axles is where the true point of contact is made with the ground.

- The International Industrial Truck Association recognizes VRLTs as Class 7 lift trucks.



- VRLT operators should understand how load types, different terrains and operating conditions affect the maximum capacity of their VRLT.

Variable Reach Lift Trucks (VRLT) are **NOT** included in this training program.

Lift trucks with man-basket

Sometimes lift trucks are equipped with man baskets for lifting personnel to elevated positions.

When used in this manner they are now Mobile Elevating Work Platforms (MEWP).



MEWP require specialized training **NOT** included in this course.

Functional Aspects of Mobile Equipment

Operator's Position



There is a large variety of lift trucks in use today performing a multitude of tasks in a variety of locations and operating terrain.

Lift truck operators need to understand the equipment they're operating; especially from the operator's cab.

The cab is usually located in a position most convenient for the safe operation of the equipment, most often centrally located on the equipment.

Lift trucks have limited visibility from the operator's cab and extra caution must be taken when reversing and turning the equipment.

Centre of Machine



The centre of equipment can be determined by locating the point at which diagonally intersecting lines from the furthest outside corners of the equipment meet.

The following image is an example of a common lift truck showing the centre of the equipment; this is also where the operator's cab is usually stationed.

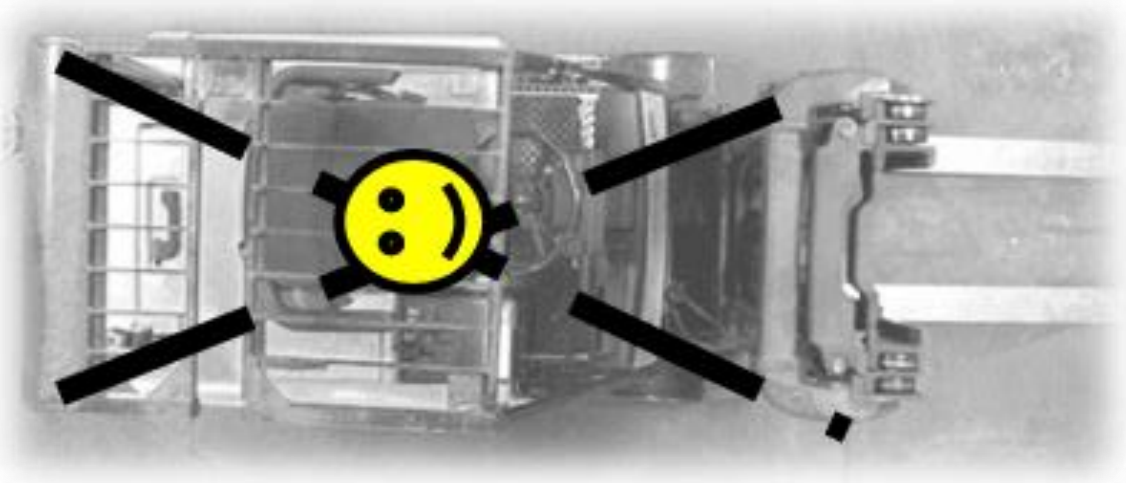

Drive

- Lift trucks are driven through an engine or motor and transmission.
- Four-wheel or all-wheel drive is used for working in rough terrain at lower speed while two-wheel (front) drive is used at higher speeds on smooth terrain.
- Some equipment uses low and high range.

Independent of how it is powered, if the equipment is of the wheeled type intended for rough terrain, it will usually operate in a low range gear with low speed using four, or all-wheel drive.

Some are hydrostatically driven.

If ever the equipment needs to travel some distance between one work location and another, many machines can shift into a higher range gear for higher speeds that involves 2-wheel drive operating at higher speed.

When equipment is traveling in 2-wheel drive, typically the front wheels provide the drive as the rear axle is disengaged while in 2-wheel drive.

Wheels, other than drive wheels, would include load bearing wheels; including "tag axle" wheels, castor wheels, steering wheels, or a combination of drive and steer wheels.

Tires and Tracks

- If the equipment is designed to operate in rough terrain, it will usually have tires or tracks appropriate for the terrain.
- Just because a tire has good tread does not necessarily mean the machine was intended to be operated in rough terrain; it could simply mean it was intended to operate outdoors.
- The tires and tracks used on lift trucks are an indicator of where it is intended to operate.

Tires

- Tires used in rough terrain will have an aggressive tread.
- Tires intended for smooth terrain will have light tread or smooth “slicks” tires.
- Tires could be filled with air or nitrogen, filled with foam or liquid ballast, or completely solid.

Rough terrain tires are the standard tires used on equipment intended to operate in rough terrain.

These tires have an aggressive tread intended to help climb and descend slopes; however, they are not as aggressive a tread used for side slope.

Lift trucks driven on tires in rough terrain tend to concentrate the weight of the vehicle over smaller areas and therefore provide the risk of sinking or bogging down in soft terrain.

Solid tires are known as cushion tires even though they feel very rough because they are solid; however, while under load cushion tires become quite soft.



These “slicks” provide for a smoother, quieter ride with less vibration placed upon the machine and operator than those with tread, especially when used indoors.

Tracks

- Tracks are especially useful in rough terrain where slopes and inclines are present.
- Tracks are also useful in soft terrain; they spread the weight of the machine out over a much larger surface area providing the benefit of “floating”.
- Steel tracks are used exclusively for rough terrain.
- Rubber tracks can be used in rough terrain as well as on concrete, asphalt or other similar surface without the risk of tearing up those surfaces like a steel track would.
- Equipment driven on tracks could be of either steel or steel with rubber pads.
- Tracks are very aggressive while ascending and descending inclines but are significantly less aggressive on side slopes.



Steering and Turning Dynamics

- All lift trucks have a means of steering and turning side to side using pivot points on which they turn.
- Operators must understand the pivot points of the equipment they're operating because the vehicles pivot points are what the operator should use to judge where and when to turn the vehicle to avoid hitting obstructions and clearing the corner they're turning.
- Equipment driven on wheels may have front wheel steer, rear wheel steer, all wheel steer, crab-style steer, skid style steering and articulating steering.

Equipment that has either all wheel steer or articulating steering uses a much smaller turning radius that allows the operator to turn within tighter corners and is often used on uneven ground where traction is limited.

Some machines can turn in a zero-radius circle.

Crab steering is used to turn all wheels in the same direction, which allows for lateral movement with no change to the longitudinal alignment of the boom.

Two-wheel steer (front tires only) is used when traveling on public roads or on flat terrain.

Front wheel steer typically has the largest turning radius of all the steering types.

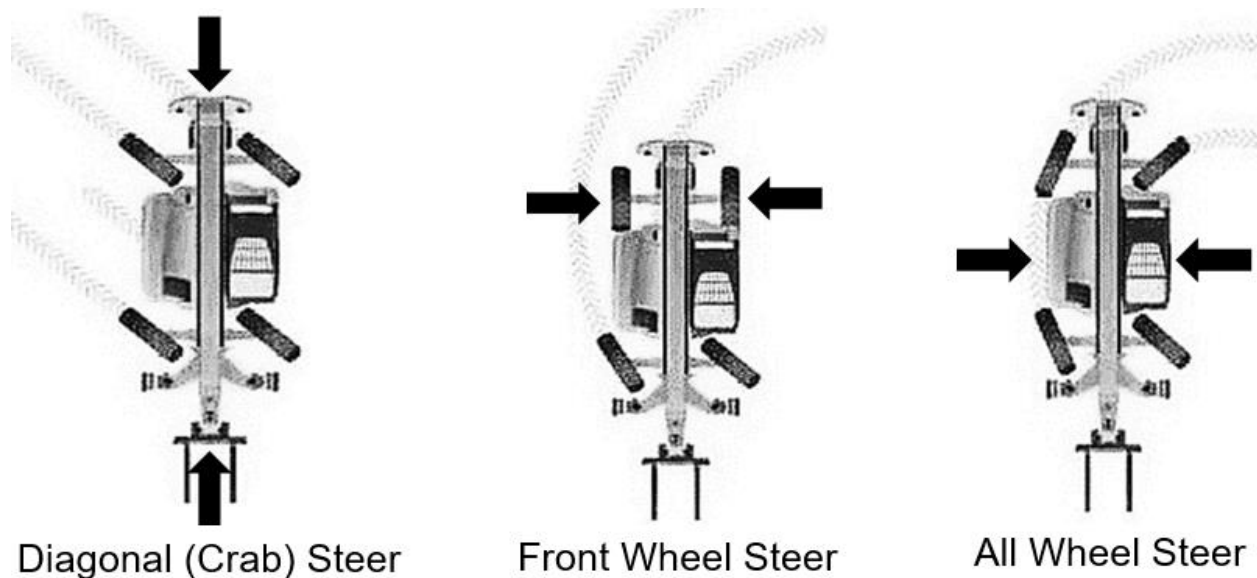

Pivot Points

- Equipment using the front wheels to steer, use the rear wheel as pivot points; and for equipment that using the rear wheels to steer, use the front wheels as the pivot.
- Remember, because the pivot point is not the steering point; use the steering wheels to direct the pivot wheels.
- The pivot point is reversed when the vehicle is reversed.
- If the equipment has multiple axles, the centre of the axles acts as the pivot point.

If we look at an overhead view of several pieces of equipment, we can see the location of the pivot points the equipment uses to turn a corner with.

The operator needs to understand the equipment's turning dynamics and pivot points and be constantly aware of these things to avoid striking something.

For equipment intended to lift and carry load at the front end of the equipment, manufacturers design the equipment with a steering mode that does not include the use of the front wheels for steering; for this type of equipment manufacturers avoid putting the heavy load over the steering axle to avoid damage that could occur to the steering mechanisms caused by the heavy load the equipment is carrying.

For this reason, equipment intended to lift and carry heavy load over the front wheels typically have rear wheel or articulating steering modes.

The opposite is true for equipment intended to carry load over the rear wheels, front wheel steer or articulating steering modes are typical.

This includes the type of equipment used to either push or pull loads.

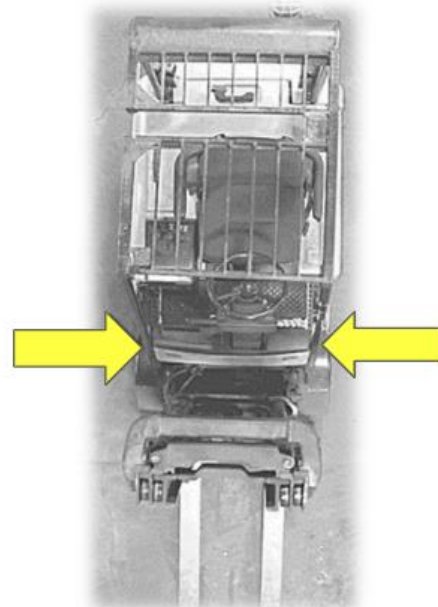

Rear Wheel Steer

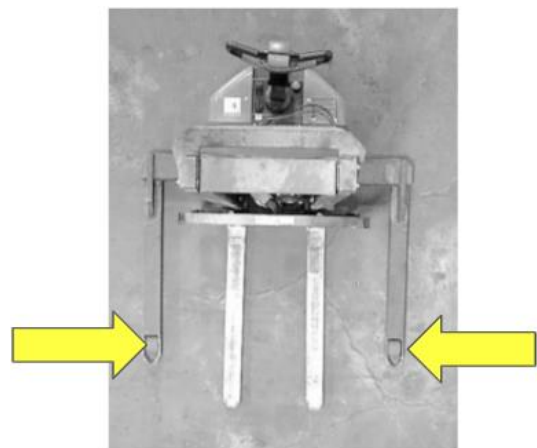

Rear Wheel Steer

Strike Points

- Whether the equipment is of the smallest size, or the largest size, they are all capable of causing damage to property or injury and even death to workers, if not operated safely.
- One of the primary issues an operator should keep in mind to avoid causing damage or injury is to know where the equipment is most likely to strike something.
- Incidents usually involve the machine driving forward or backwards and striking something it shouldn't.
- Due to the various steering modes of lift trucks, the most likely area the equipment will strike an object or person is in the forward most right and left corners of the attachment as well as the rear right and left sides of the counterweight.
- Equipment must be positioned so that no swinging portion of the equipment can come within 60 cm (2 ft) of any obstruction in any area accessible to workers, or entry to such areas must be prevented by barriers or other effective means.

Primary Strike Points

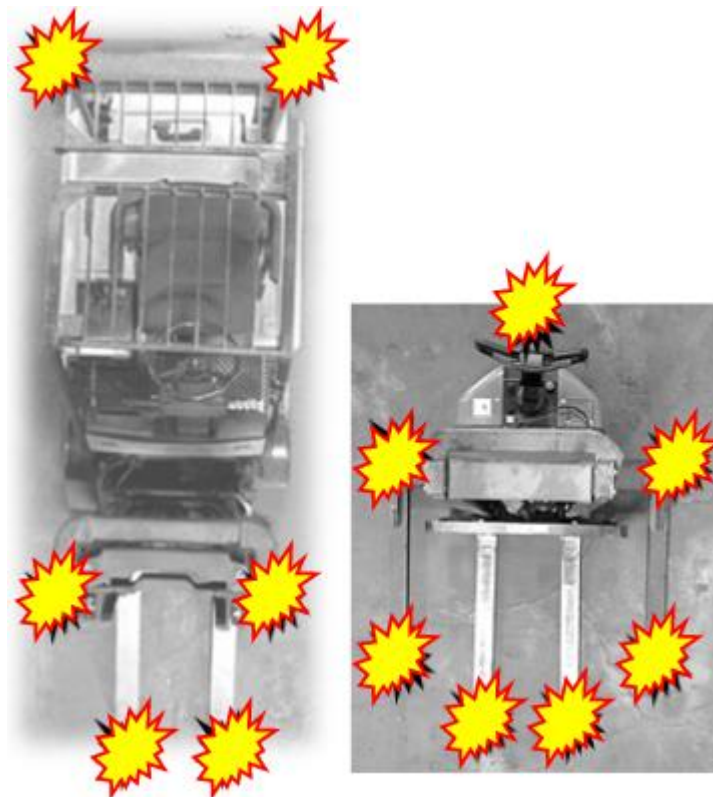

Chapter 5, Slide 26 – Warehouse Collapse Video

Stability

Stability Shapes

- Lift trucks are designed to be stable while performing the duties the equipment was intended to perform, if the equipment is operated within the range and scope intended by the manufacturer.
- Even though so much equipment is designed to lift and carry loads under various conditions, the equipment is most stable while it is stopped, sitting level in a neutral position, with its load placed low to the ground close to the machine.
- Therefore, the stability of the machine will be affected by the forces placed upon the machine while it's performing its duties.

Every operator needs to understand the principles of force, the types of forces, and the affects these forces have upon the stability of the machine they're operating; otherwise, the effects could be quite hazardous to the machine and its operator.

To do this, the operator needs to know the safe operating parameters in which the Mobile Equipment can operate.

As discussed earlier, the operator is typically stationed to operate their equipment near the middle of the machine and as a result, would sit centralized within the stability shape of their equipment.

The operator needs to determine what type of stability shape the machine operates under and where the centre of gravity lies within that shape.

To do this, we first need to identify the points of contact the machine has with the ground.

Points of Contact with the Ground

- Lift trucks make contact the ground in at least 3 points, most have 4.
- Where there are double load bearing wheels, or tandem or triaxles, the centre between the axles or centre between the load wheels is where the true point of contact is concentrated, this is also the pivot point on combination axles.

These points of contact with the ground could be through the machine's wheels, outriggers, skids, tracks, or other similar means.

The bottom dead-centre of the wheels is where we determine the actual contact to be made.

These points outline what we use to determine the centre of the machine, for which the centre of gravity needs to remain within or risk roll-over.

- If the machine has three points of contact with the ground plus a point located near the top of the load at maximum height, we're looking at the shape of a tetrahedron.

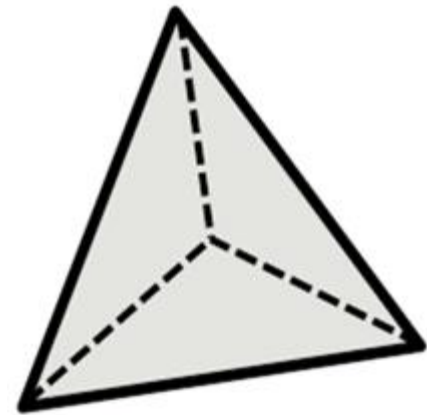

Tetrahedron

- If the machine has four points of contact with the ground plus a point located near the top of the load at maximum height, we're essentially looking at the shape of a pyramid.

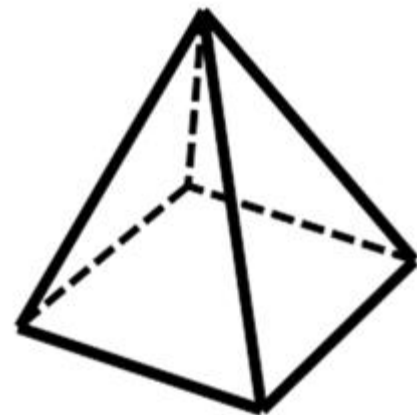

Pyramid

The top point is located near the uppermost part of the equipment.

For example, for those machines intended to push or pull like a motor grader, bulldozer, earth scraper or other similar equipment, the point is located at the top of the operator's cab because this is the highest point located on the equipment.

Whereas, with a piece of equipment intended to lift and carry load such as a lift truck or loader, the top point is found at the location where the centre of mass of the load is expected to be while at maximum height.

For example, the top point on a lift truck is 24 inches above the forks while at maximum height, and for the loader, the centre of the attachment elevated to its maximum height.

- Where the equipment is equipped with an oscillating axle, the oscillating point is the point at which all the weight is concentrated; therefore, when we determine how many “true” points are made with the ground, we calculate 3 points rather than 4.



- Because the rear axle oscillates, it is less stable than the front axle.

Most articulating loaders, counter-balance lift trucks and, variable-reach lift trucks have their rear axle connected to the frame on a centre pin.

Most motor graders have their front axle sitting on a common centre pin as well.

To determine whether the specific piece of Mobile Equipment is truly under the stability shape of a tetrahedron or a pyramid, one will need to determine whether one of the axles oscillates or not.

Stability Triangle

- The triangle is measured from the centre of the ground contact.
- These three points of contact connect to create the shape of a triangle.
- The points that connect the front wheels are much broader than the single narrow point on the rear axle of the machine.
- Combining the strength and breadth of the front axle makes the machine more stable in the front than the rear.
- The front axle will pivot on a fulcrum forward and back much easier than it will side to side.
- Because the rear axle oscillates on a single large pin, the rear axle is less stable than the front axle.

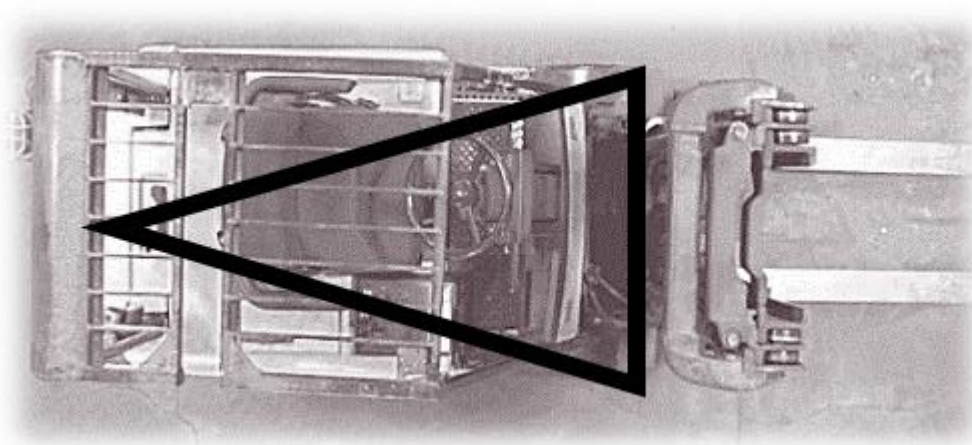

Stability Tetrahedron

- Lift trucks are intended to lift their load, so we need to consider the lifting height of the equipment and how height influences the stability of the equipment.
- First, determine the maximum height the centre of gravity of the load may elevate to, and then intersect that height with the centre of the equipment thus determining the top-centre point of the equipment.
- Then connect the point at top centre of the machine with the points that outline the stability triangle.

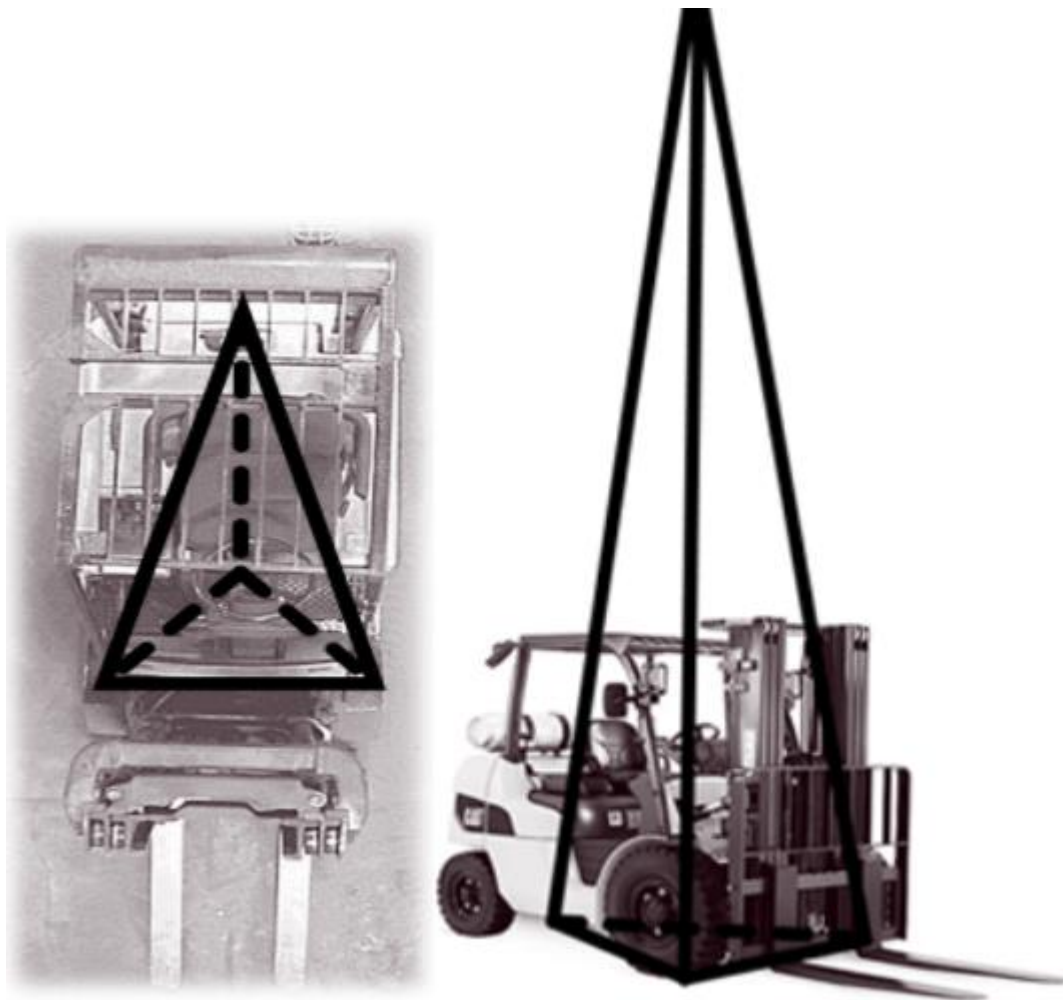

Stability Rectangle

- Unlike other Mobile Equipment that has an axle with a centre pin, there are many styles of equipment that do not have oscillating axles.
- Examples include skid steer loaders; elevating work platforms, and class 2 lift trucks to name a few.
- The bottom centre of the four wheels is where we determine true contact to be made with the ground. These four points of contact connect to create the shape of a rectangle.

Top View

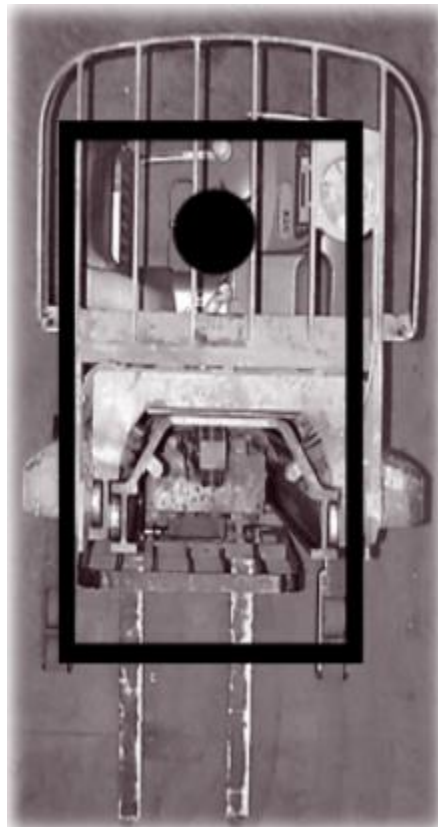

The Stability Pyramid is created when there are 4 points of ground contact

- Determine the maximum height the centre of gravity of the load may elevate to.
- Intersect that height with the centre of the machine determining the top-centre point of the machine.
- Connect the point at top centre of the loader with the points that outline the stability rectangle.



Fulcrum

- Lifting loads with equipment utilizes the theory of balancing a weight over a fulcrum.
- The forward fulcrum on equipment with load runs through the centre of the front plane of the machine's stability shape.

An example of the fulcrum is a “see-saw” or the “teeter-totter” effect.



If too much weight is on the front of the equipment's attachment, the equipment can tip forward.

Or, if the machine approaches an incline with the center of gravity facing downslope, the machine becomes unstable.

- To counteract this problem, equipment designers add a counterweight at the rear of the equipment.

The other fulcrums are represented on the other planes of the stability shapes.

For machines intended to lift and carry load, the purpose of a counterweight is to offset the potential load to be carried.

The counterweight is designed to offset the maximum capacity of the machine lifting the load.

The operator needs to keep in mind that although the load may come and go, the counterweight is always with the equipment.

As such, the centre of gravity will change as the machine loads and unloads.

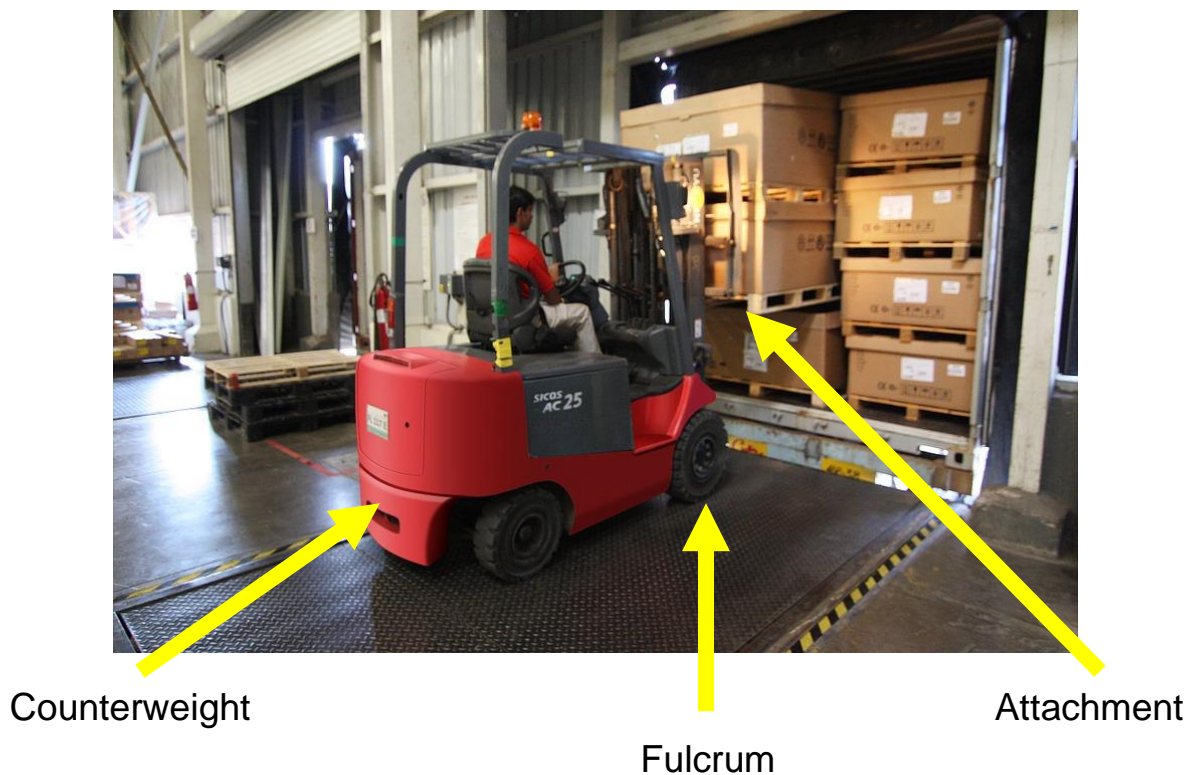

On level ground, 70% of the machines centre of gravity sits over the rear fulcrum due to the counterweight.

Whereas, when the equipment is with load at its maximum capacity, 70% of the weight ends up over the forward fulcrum of the equipment.

If the equipment were to ever become loaded beyond capacity, the likelihood of the equipment tipping forward increases.

As a load is placed on the attachment, the equipment's centre of gravity shifts towards the front fulcrum of the equipment.

This will occur because most of the weight is now in the front of the machine.

This lift truck has a 60 / 40 extendable counter weight and is capable of lifting 60 tons.



Increased Stability Using Straddle Legs

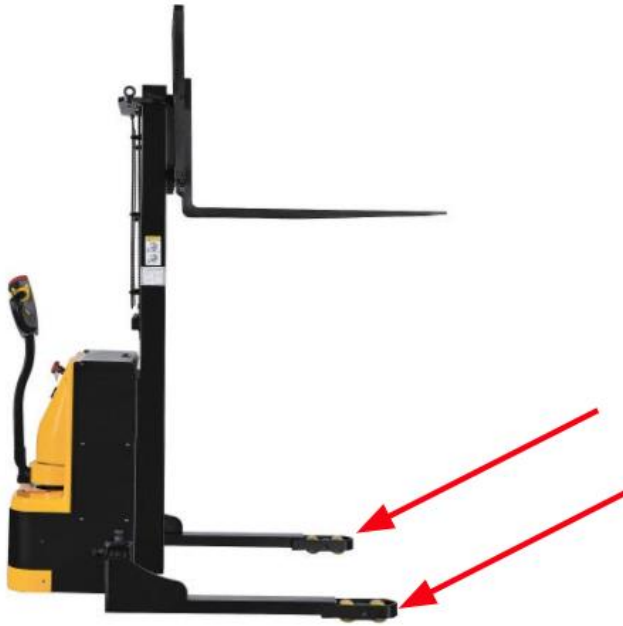

- Straddle legs can play an important function to keep your equipment stable.
- These “straddle legs” (stabilizers) increase the height to which the load can be lifted safely.

Center of Gravity of Machine

- Operators need to pay special attention to the center of gravity on their lift truck because it can shift outside the stability shape causing instability and possible roll-over.
- All lift trucks have a Centre of Gravity located somewhere within the equipment's stability shape.
- Consider these "balance points" or "fulcrums" to be the outside of the equipment's stability shape".
- Equipment is stable, if operated as intended by the manufacturer.
- Equipment is most stable while stopped, level, with load low to the ground and close to the equipment, it is under these conditions that maximum capacity can be attained.
- Once the centre of the machine is located, we need determine where the equipment's centre of gravity lays within its stability shape.
- Remember, the closer the centre of gravity lies to the centre of the equipment, the more the equipment becomes stable.
- Conversely, the further the centre of gravity gets away from centre of equipment, the less stable it becomes.
- The center of gravity can shift outside the stability tetrahedron causing instability.
- As a load is lifted, the center of gravity moves up along the pyramid/tetrahedron where the top becomes narrower.
- It can be clearly seen that the higher the load is lifted the less room you have within the stability shape.
- If the center of gravity falls outside the stability shape the equipment will become unstable and risk tipping over.

The images below illustrate how the centre of gravity shifts towards front fulcrum sits while load is placed on the attachment.

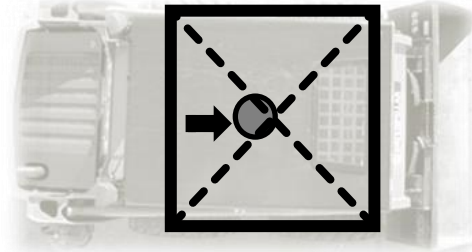
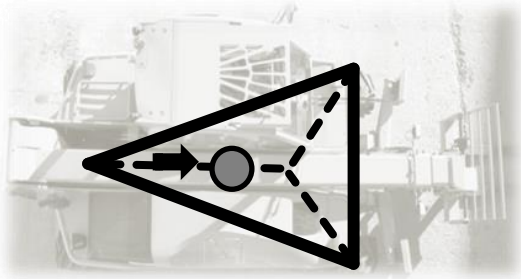

Because the center of gravity (depicted by the solid circle) lies within the stability tetrahedron, the machine remains within its range of stability.

Operators need to pay special attention to the center of gravity on their lift truck because it can shift outside the stability shape causing instability and possible roll-over.

The counterweight is designed to offset the maximum capacity of the machine lifting the load.

Notice where the centre of gravity sits while the machine is stationary and at height.

Looking at the stability tetrahedron, we can see that the centre of gravity falls well inside of it.

The heavier the load carried, or the further the load extends, the more the centre of gravity will shift toward the fulcrum.

If the load exceeds the capacity of the equipment, the center of gravity will shift beyond the fulcrum and tip it forward.

Because the center of gravity (depicted by the solid circle) lies within the stability tetrahedron, the machine remains within its range of stability.



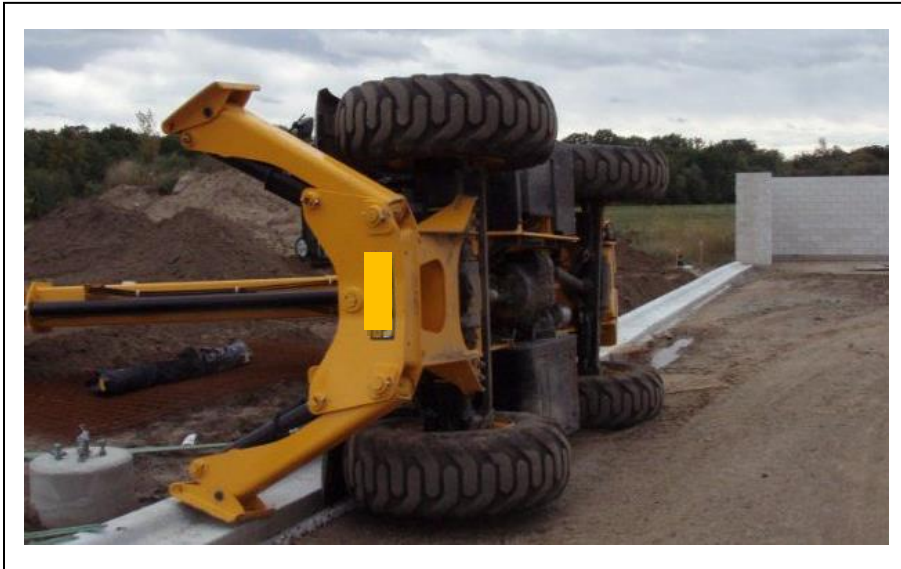

What happens when the centre of gravity falls outside of the stability tetrahedron?

Static vs Dynamic Stability

Now that we understand the principles of stability, we need to consider the effect of motion on the equipment's stability.

- When an object is stationary (not moving), it is said to be in the state of static equilibrium.
- When an object is in motion it is said to be dynamic, or constantly changing its stability.
- It is important to understand the difference between the two because it greatly influences the stability of the equipment while in use.

Operators should know how the center of gravity of the lift truck with and without load, as well as an incline or slope of the surface influence the machine they're operating.

The easiest way to look at these forces is to consider the pendulum effect of objects in motion.

Consider a pendulum hanging inside the stability shape, if we were to accelerate the equipment (in a forward direction) what do you think would happen to the center of gravity?

Initially the pendulum ball would stay static relative to the ground, however, as the equipment moves forward, which in turn (relative to the equipment) would move the pendulum ball towards the rear point of equipment's stability shape.

Theoretically it is possible to move the pendulum ball past this point resulting in equipment tip-over.

Fortunately, equipment design restricts this from happening.

For example, if we looked at a motorcycle the same theory would apply.

If a motorcycle accelerates too fast, it would flip backwards injuring the operator.

The opposite effect happens when you stop or slow down too quickly, the pendulum swings forward towards the forward fulcrum.

If the equipment was to stop too fast while loaded, the pendulum could swing beyond the fulcrum and cause the equipment to tip forward, most likely dumping the load and injuring the operator.

Lateral and Longitudinal Stability

- Longitudinal Stability: Stability of the equipment from front to back.
- Lateral Stability: Stability of the equipment from side to side.



- Operators should remember, if the machines lateral plane is shorter than its longitudinal plane, it will be less stable side to side.
- The same is true if your equipment has a shorter longitudinal plane; it will be less stable end-to-end.
- Stability will be highest while under load.

Maximum stability is achieved if the machine is level.

If stabilizers are available, use them to keep the inclinometer in the level position.

You should never drive with a load raised across a slope or grade; there is a high chance that the equipment could lose lateral stability.

If stabilizers are not available, consider repositioning your machine to more level ground.

It is important to check tire pressures to avoid upsetting the lateral stability of the machine.

Remember it is easier to become laterally unstable because of the narrower points of contact with the ground.

It is always best to keep the machine perpendicular to a building to keep it longitudinally stable.

For Mobile Equipment with the stability shape of a tetrahedron the operator should realize that lateral stability decreases without load, especially at height due to the narrow points at the rear of the tetrahedron.

Mobile Equipment with the stability shape of a pyramid is more stable at the rear than the rear of Mobile Equipment using the tetrahedron.

The following illustrate both the lateral and longitudinal axis from the top and side view of the machine's stability shape.

Top view

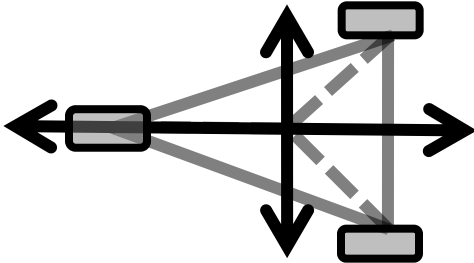

Certain lift trucks etc.

3 dimensional views

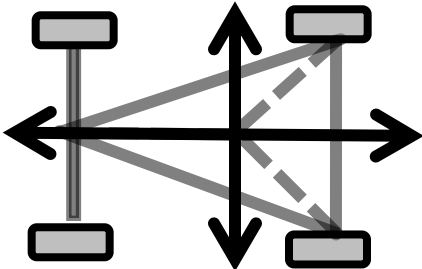
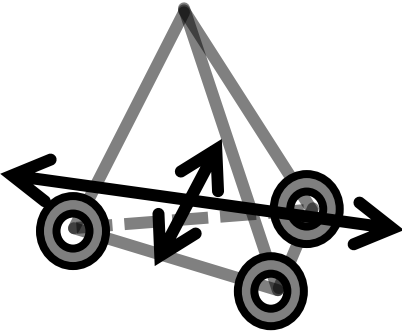

Counter-balance lift truck.

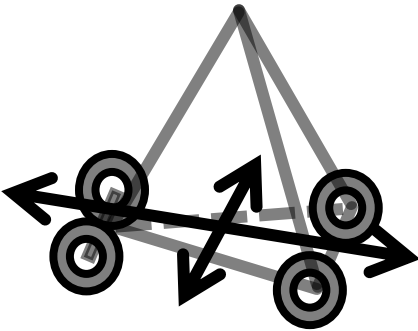

Top view

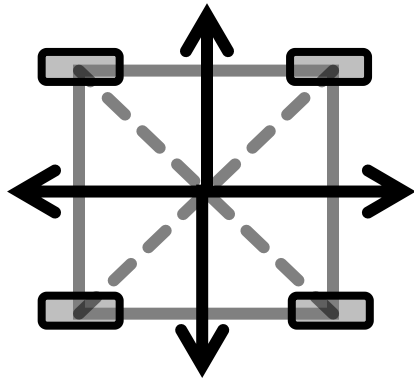

3 dimensional views

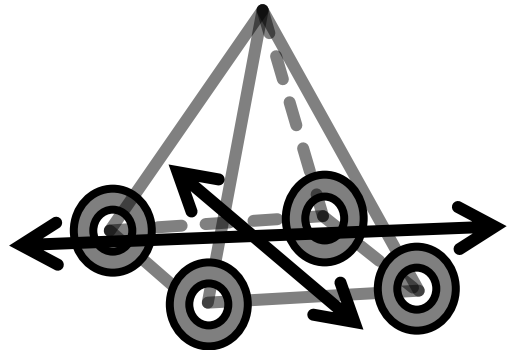

Class 2 lift trucks.

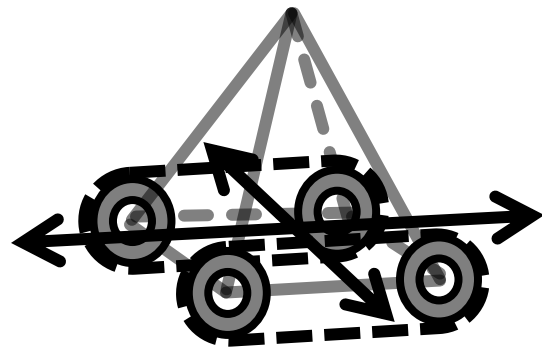
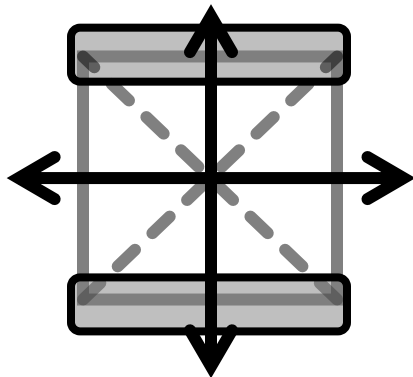

Lift trucks equipped with tracks

Factors Affecting Stability

- Understanding the principles of stability allow operators to understand the factors that can influence the lift truck's stability.
- No matter where the lift truck is operating, there will always be a variety of forces acting against the stability of it.
- Consider the effect of leverage, centrifugal and centripetal force, wind and the terrain.
- The equipment has been designed to work in a variety of conditions including rough, uneven and sloping terrain which will subject the equipment to forces affecting both the longitudinal and lateral stability of the machine.
- Understanding longitudinal and lateral stabilities of your Mobile Equipment is especially important when operating on slopes and inclines.

Leverage

- Mobile Equipment without load will have its centre of gravity located towards the back of the equipment, or rear fulcrum.
- Once load has been placed upon the lifting attachments, the force of leverage will drive the centre of gravity from the rear fulcrum of the equipment towards the front fulcrum.
- This is further compounded when the load is elevated.

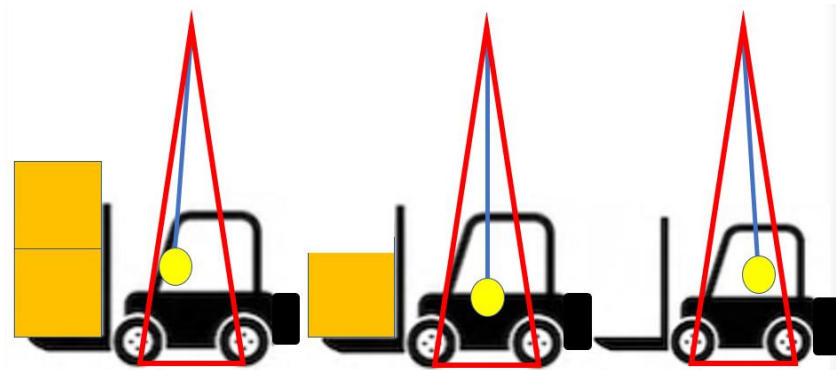

Operators need to consider the effect of leverage upon their equipment while lifting and carrying loads.

Operators need to remain aware of the leverage effect while operating; the consequences of a roll-over could be disastrous.

As the centre of gravity shifts forward past the fulcrum, the equipment will tip over frontwards.

To prevent this from happening, equipment manufacturers restrict the equipment's operating capacity to be less than the machine's tipping capacity.

Maximum Reach

- When the attachment is raised to a position level with the horizon and extended to its maximum distance from the machine, the attachment will be at its furthest point away from the nearest fulcrum, or balance point; this point is known as the maximum reach.
- It only makes sense that this will be the most dangerous place to hold a load.
- This image shows a lift truck at it's maximum reach with load.



If the machine were to ever become loaded beyond capacity, the likelihood of the machine tipping forward increases.

Operators should always travel with the load as close to the machine and as close to the ground as possible while still being able to clear any ground obstructions.

Centrifugal Force

- The effects of speed, acceleration, sharp cornering, height, attachment, grade or ramps and load security all combine to affect the lateral stability of the equipment.
- Circular motion cannot occur without a force pulling toward the centre, that is centripetal force.
- Centrifugal force occurs when mass is fleeing from the inside towards the outside. It is caused by inertia.
- Centrifugal force is applied to the mass sitting above the equipment's centre gravity.
- Centrifugal force occurs when equipment in motion turns a corner.
- Due to the principle of centrifugal force the pendulum would swing to the outside and could possibly tip the equipment on its side.

Centripetal Force

- Centripetal force is the equal and opposite of centrifugal force.
- This is a force that moves towards the centre.
- Centripetal force is applied to the mass sitting below the equipment's centre of gravity.
- Like centrifugal force, centripetal force occurs when equipment is turning a corner.
- Deceleration contributes to the effect of centripetal force.

Chapter 5, Slide 64 – Fire truck rollover video.

Wind

- Wind force is applied to both the equipment and its load.
- It is important to take wind load into account when performing your hazard assessment.
- Always refer to the operator's manual to determine safe operating conditions due to wind load.

Sudden wind gusts applied against the machine and its load can be enough to cause tip-over.

The effect of wind is compounded by having the load at height giving it the effect of a wind sail.

It can be especially disastrous if workers are elevated in a work platform.

Chapter 5, Slide 66 – Miller Park Wind Incident Video

Slopes and Inclines

- Knowing where the centre of gravity sits within the machine's area of stability is the key to knowing how slopes and inclines affect the equipment's stability.
- We learned earlier that equipment sitting under static forces without a load carry approximately 70% of its load near the rear fulcrum of the machine, and approximately 70% of the weight is over the front fulcrum when loaded.

The operating terrain should always be considered while operating your equipment.

If the operator needs to climb or descend a slope or incline of any significance, the operator should know how combined forces affect the stability of the machine.

Inclines

An equipment operator faced with travelling up or down an incline without load should know that based on the principles of the stability shape, the force of leverage caused by the counterweight will drive the centre of gravity towards the rear fulcrum reducing the stability of the equipment.

Remember, due to the narrow aspect of the rear fulcrum of equipment whose stability shape is that of the tetrahedron, that in addition to rear longitudinal stability being compromised, lateral stability is also compromised; however, with load the centre of gravity will sit closer to the front of the machine allowing for greater lateral stability.

The operator should also keep in mind that due to the limited amount of weight on the front axle, traction will also be reduced.

Inclines Without a Load

When an operator has no load, the operator should approach the incline with the empty attachment facing downhill, with the counterweight facing the up-hill side; this will drive the centre of gravity towards the centre of the machine increasing both stability and traction to climb and descend the hill.

For example, if equipment without load is at the bottom of an incline and wants to travel uphill, the operator should do this in reverse. If the equipment operator is at the top of the hill, the operator should drive with the empty attachment facing downhill.

Having the empty attachment facing downhill could also prove beneficial should the equipment lose some control or traction.

The attachment can be lowered to assist in braking and prevent sliding in an uncontrolled situation.

Inclines with a Load

- Because the centre of gravity shifts towards the front fulcrum of the equipment with load and using the knowledge of the stability shape the equipment operator should approach the incline with the loaded attachment facing uphill.
- Facing downhill with a load not only increases the likelihood of the equipment losing stability and traction, but the load is also likely to be lost while facing downhill, especially if braking.

For example, if the operator needed to climb a hill, he should approach the incline with the loaded attachment facing uphill. If the operator needed to travel down the incline, it should be done in reverse with the loaded attachment still facing uphill.

The following images illustrate both the correct and incorrect method of travelling on an incline WITHOUT a load.

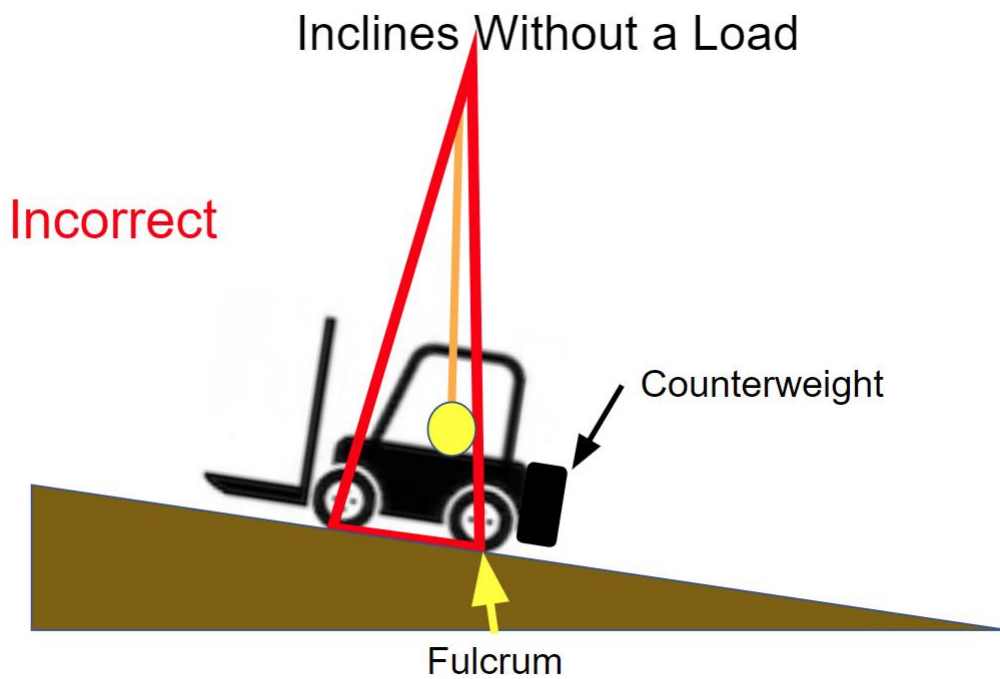
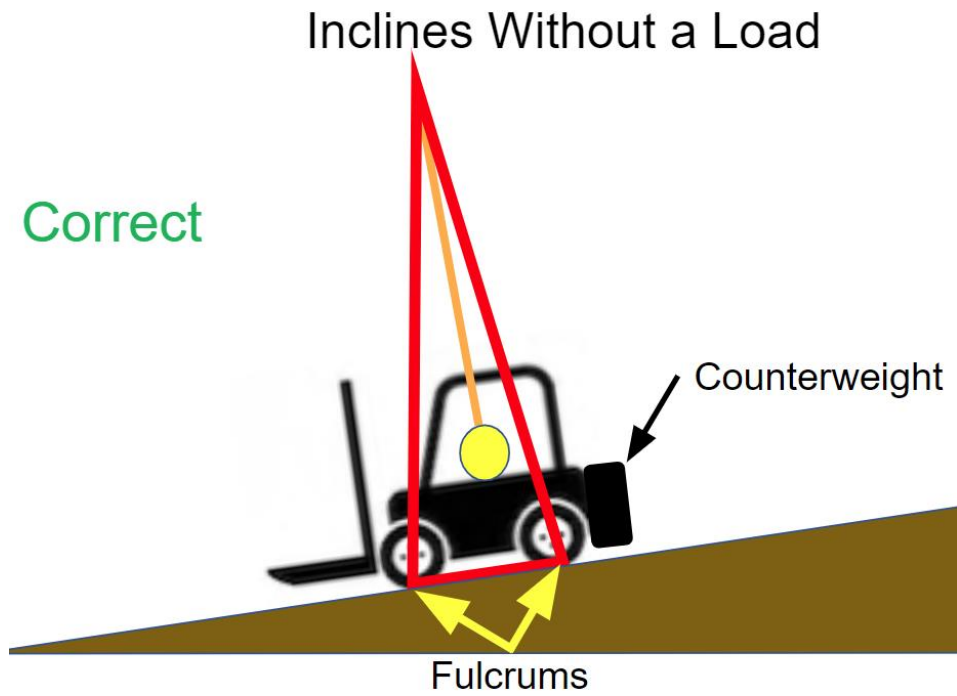

The following images illustrate both the correct and incorrect method of travelling on an incline WITH a load.

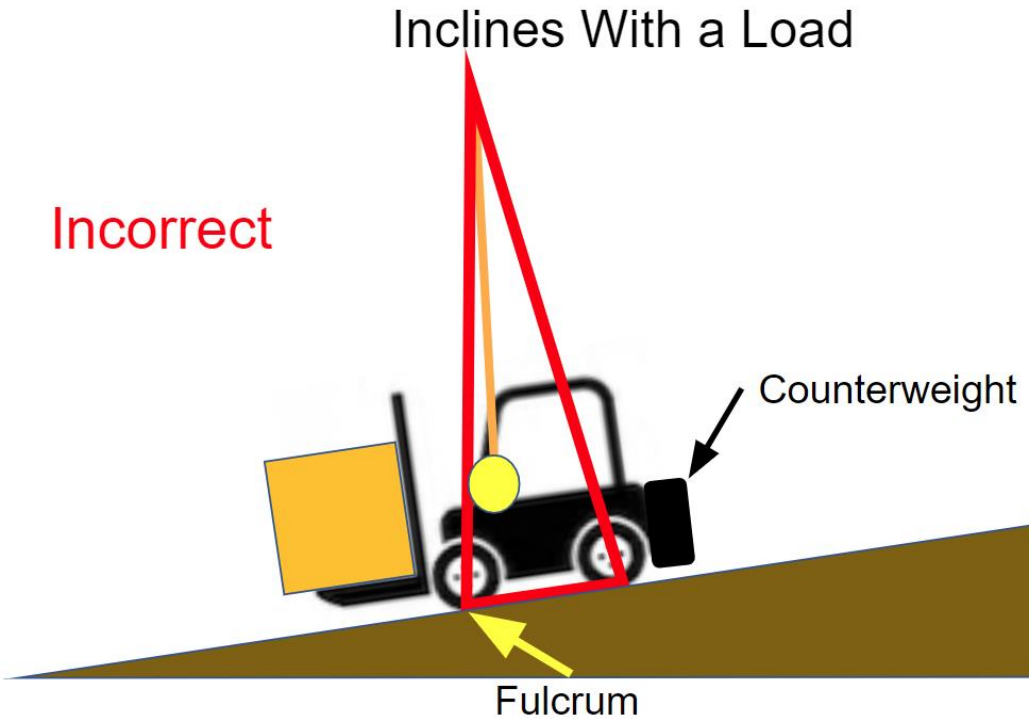
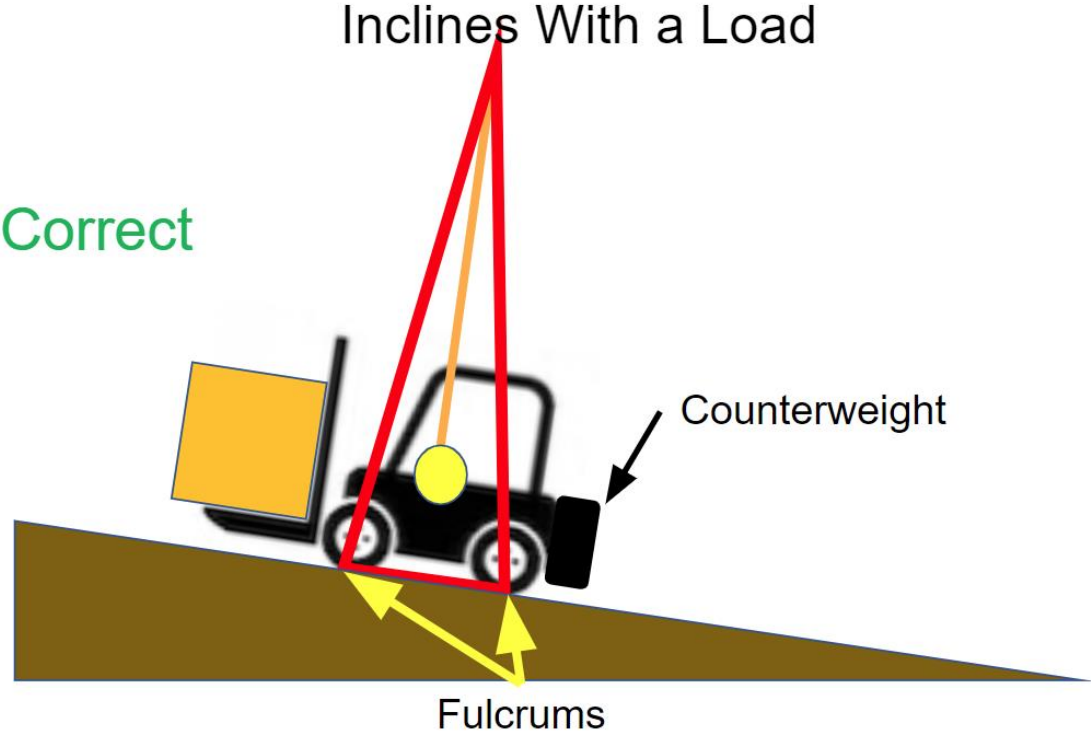

Side Slopes

- Slopes have a serious effect on the lateral stability of the equipment.
- Due to the relatively narrow shape of the stability tetrahedron, degree of slope and height of load combined will cause the equipment to become unstable quickly.
- Try to avoid operating on side slopes.

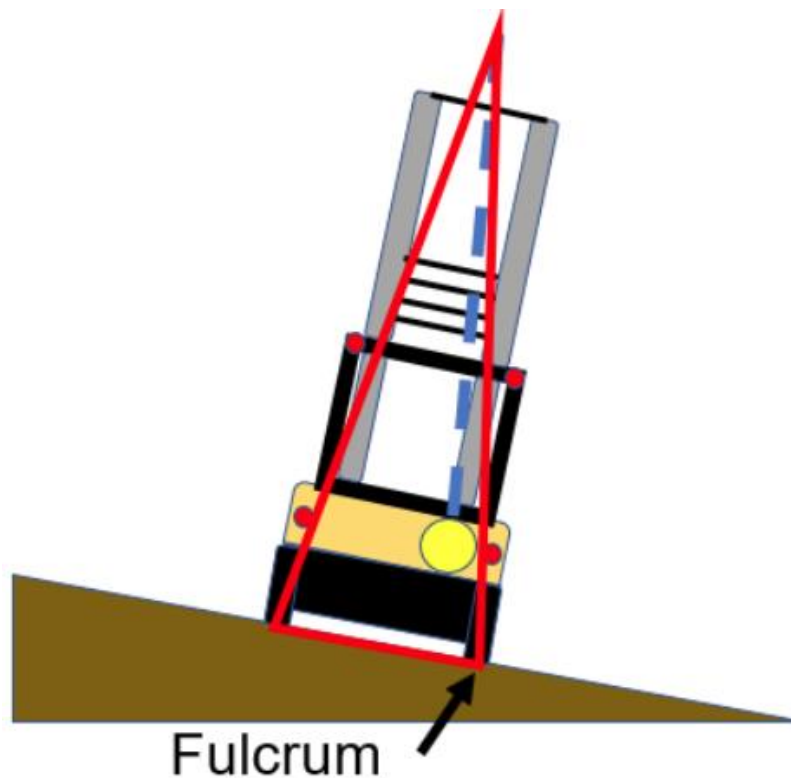

- If you must travel on a side slope, it is very important to keep the load as close to the ground as possible.
- Due to the cross angle of the slope, the treads on the equipment tires and tracks may not provide as much traction as expected.
- If the equipment starts to slip sideways, turn the equipment down slope and lower the attachment.

Always refer to the machine specific operator's manual
for incline and side slope ratings.

Tips for Operating on Inclines and Slopes

Always refer to the operator's manual for maximum slide slope operation.

Eliminate the hazard when ever possible, try to avoid working on inclines and side slopes.

Check out all slopes and inclines before beginning travel.

Take measures to reduce the risk of losing control or rolling over, for example:

Attempt to build a flat pad to work from when conditions permit.

Pile material on the uphill side of the slope.

Look for water, ice, snow, or other debris that makes travel hazardous.

Always travel in the center portion of the slope or incline.

Always keep the load low and level when traveling on any type of slope.

Travel straight up or down and incline. Avoid crossing a slope.

Never turn or raise loads on an Incline.

When the load is raised, less movement will be necessary to turn the equipment on its side.

Never attempt to turn or travel with the attachment at height.

Never raise a load if the equipment is facing downhill; this will cause the back of the equipment to leave the ground easier and less weight is needed to create an out-of-balance condition.

Avoid sudden or jerky moves when the load is raised on a slope or incline.

Be ready to turn machine downhill and lower the attachment if machine begins to slide.

Chapter 5 Summary:

What was Covered in Chapter 5?

- Common types of lift trucks.
- The basic structural components of lift trucks and how they function.
- Potential hazards while operating lift trucks and how to control those hazards.



© Saga Universal Training Corp 2021

CHAPTER 6: ATTACHMENTS AND HANDLING MATERIAL

Lift truck operators are responsible for themselves, their machine and the people around them. When handling various materials such as dirt, stone, pipe and loads on forks it is easy to develop a narrow focus on the immediate job at hand.

Think, then work!

Think ahead so that you don't have to move loads twice or more.

Work as a team, the equipment operator is very important to help others get their job done.

Goal:

- The student should have a basic understanding of the proper use of lift truck attachments and potential hazards associated with Mobile Equipment attachments.

Objectives:

1. The student should be aware of various attachment options for lift trucks.
2. The student should be aware of the possible effects' attachments may have on the operation of lift trucks.
3. The student should be aware of potential hazards associated with using various attachments and how to control those hazards.
- 4 The student should understand the importance of acquiring additional training from a competent person on specific lift trucks and attachments and their application at their worksite.

Attachments

- A lift truck usually comes with a standard set of four-foot forks.



Paper Roll Clamps



Bale Clamps



Carton Clamps



Tobacco Carton Clamps



Rotator



Hinged Forks



Drum Clamps



Flat Holding Block Clamps



Bell Type Brick Clamps



Forks Clamps



Turnaload



Foam Rubber Clamps

Changing Attachments

- Ensure the proper attachments for the job are available and stored in an accessible location.
- Use attachments in the manner they are designed and rated for.

Using the right tool for the job reduces damage to property and equipment and increases safety for workers.

An experienced operator understands that the equipment he has might not be right for the job at hand.

Always have the correct number of operators present when changing an attachment.

Change attachments on a level surface.

Ensure the equipment and attachments are secured against any movement.

Report damage to mounting hardware immediately.

Report significant wear or signs of stress cracks in the attachment surface.

Check all attachment pins daily when adding attachments.

Visually inspect attachment to verify that pins are fully in slots.

Connecting Hydraulic Lines:

- Park equipment in safe location.
- Ensure attachment is resting on the ground.
- Relieve hydraulic line pressure before attaching hydraulic auxiliary lines.
- Follow the manufacturer's procedures.

Capacity Restrictions

- Do Not Overload the Attachment.
- If the machine is used beyond the manufacturer's rated capacity, the manufacturer may void any warranty leaving the operator and employer liable for anything that goes wrong while using the machine beyond the machines scope.

Increased attachment load will ultimately overload the machine.

To maintain stability, keep the attachment or load close to the ground while ensuring there is still enough clearance for the operating terrain; for smooth terrain, 4-6 inches from the lowest part of the attachment or load, 12-16 inches for rougher terrain.

When the machine uses a different attachment other than the one intended for the machine, the capacity of the machine will change too.

Using the attachment for the wrong material can also change the machine's capacity; for example, using a light materials bucket for heavy material.

It's very important for operators to remember that a machines capacity is calculated using the centre of the standard attachment intended for the machine.

The lifting arms or mast may not support the weight of the attachment.

The attachment could be significantly heavier than the original attachment; for example, which will cause the machine to become unstable and risk roll-over.

Other restrictors to a machine's increased capacity may be due to the overhead protection structure, the machines carriage and frame, its tire, and motor strength.

Rarely is the capacity increased as the attachment changes, the capacity will either stay the same or be reduced.

The protection structure is usually designed to withstand the machines maximum capacity falling from a specified height.

The carriage assembly and frame may not be designed to support the extra load, or the motor may be underpowered to operate under increased capacity.

Maximum Operating Capacity

- Capacity ratings are calculated using the attachment that came with the machine from the manufacturer.
- If the machine changes attachments, the machines capacity changes too.
- For lift trucks, usually forks; for loaders, usually a heavy materials bucket.

To achieve maximum capacity on equipment the:

- Vehicle must be stopped.
- Vehicle and its load must be level.
- Load must be lowered and retracted.

Tipping Capacity

- The tipping capacity of a machine is the amount of load required to upset the machine.
- Lift trucks typically have a maximum rated operating capacity of approximately 70% of the machines tipping capacity.
- Tipping and operating capacities are listed in the equipment operator's manual and should also be in a conspicuous location somewhere on the machine.



© Saga Universal Training Corp 2021

Capacity Plates

- Laws require that every piece of equipment intended to lift load have a capacity plate permanently fixed to the machine.
- With some equipment you may have to cross reference the manufacturer's ID plate with the operator's manual for that specific machine.

They typically show the following information.

Type / designation

Vehicle mass (weight)

Capacity rating at a given load centre and Maximum lifting height of attachments

The attachment type

Minimum / maximum battery mass (weight)

Example:

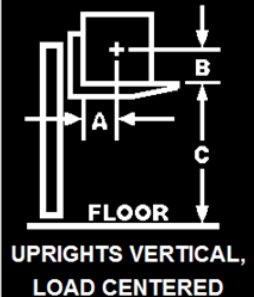
 <p>UPRIGHTS VERTICAL, LOAD CENTERED</p>	Capacity	A	B	C	Attachments
		2775 LBS	24 IN	24 IN	159 IN
	1525 LBS	24 IN	24 IN	189 IN	and Forks Only
	1280 KG	600 MM	600 MM	4069 MM	55F-SSS-A015
	700 KG	600 MM	600 MM	4810 MM	X X X X
	Model #	H 99R - 04		Serial #	999-999-999-999

- The maximum weight capacity of this sit-down counterbalanced lift truck is 2775 LBS (1280 KG) with the load centre 24 inches (600 MM) from the “heel” of the forks.
- Notice that as you increase the height of the load the capacity decreases from 2775 LBS (1280 KG) to 1525 LBS (700 KG). This change in the capacity considers the stability of the lift truck.

Most pallets are four feet by four feet; therefore 24 inches should be considered the centre of the load.

Some lift trucks may or may not have a capacity that decreases with the height of the load.

The sample plate below shows that the capacity of this lift truck is 4500 LBS (2040 KG) at a total height of 240 inches (6095 MM) with the load center being 24 inches (600 MM) from the heel of the forks. (This lift truck can safely lift its maximum rated capacity at maximum height and reach).

RR
S 2 0 0
S E R I E S

Units of measure, kg/mm(lb/in)

Mast Collapse Height	2720 (107)	Truck Type	E
Truck wt. as Equipped w/ Max. Battery	4060 (8951)		

Attachment Data
SIDESHIFTER

Serial Number
1A288374

Capacity with Upright Vertical

	(A)	(B)
2040 (4500)	6095 (240)	600 (24)
0	0	0
0	0	0
0	0	0

Diagram labels: Load Center 600 (24), A, B, 332-0018

Load Centre and Load Centre of Gravity

Ensure only stable loads are moved, otherwise a shifting load can fall damaging the product or injuring the operator.

If the operator is expected to move hazardous materials, the employer should develop specific company procedures to ensure the safe handling of these loads and the operator should use extra caution.

- Like what we learned regarding the centre of the equipment and the centre of gravity of the equipment, the load that the equipment is intended to lift and carry also has a load centre, and centre of gravity.

A competent operator is one who knows the weight and dimensions of his load, but also where the centre of gravity lies for the load being carried.

Without this knowledge, the operator faces carrying an unstable load or making the equipment unstable.

Load Centre

- To calculate the centre of a load, simply draw intersecting lines from the furthest outside diameter of the load, the point at which the lines intersect is the centre of the load, it may not be the same as the load center of gravity.

Load centre of gravity

- The center of gravity of the load is the point at which the load mass is concentrated.
- It is usually located $\frac{1}{2}$ way between the horizontal and vertical lines of the load.
- Some loads may have a centre of gravity that is off set from the centre of the load.

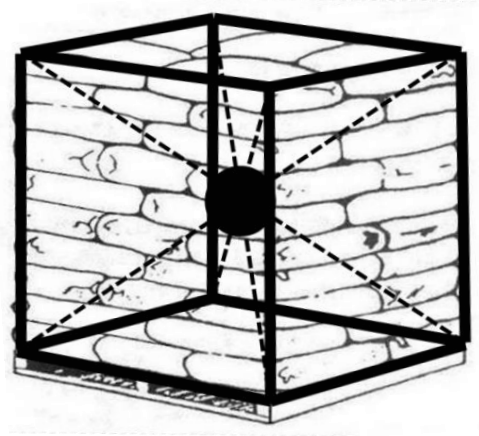

The operator needs to distinguish the centre of the load from the centre of gravity of the load.

The centre of gravity of the load should be centred in the machines lifting attachment; its forks or bucket, etc.

Load Charts

- Load charts are one of the most important pieces of information that operators need to understand when operating variable reach lift trucks.
- A load chart must be displayed in the operator's cab if the rated load varies with the reach of the equipment.
- Load charts are calculated by certified professional engineers based on the following factors:
 - Weight of the load.
 - Boom extension.
 - Boom angle.
 - Attachment type (Forks, bucket, jib crane, etc.).
 - Stabilizer positions up or down.

Know the equipment and the load.



© Saga Universal Training Corp 2021

Reading Load Charts:

- Load charts are typically based on 24" load centers from the surface and heel of the forks.
- To read the chart you always select the coloured segment of the next highest weight.
- For example, if you have an 1800 lb. weight you move to the 2000 lb. segment. This would be the maximum load segment for your load.

You then look at the left-hand edge of the segment to show the stability limits for your load.

Operators need to keep weights, angles, and extensions to the right of the maximum stability limits for that lift.

Limits on the charts are based on a stationery and level machine.

Do not raise or extend the boom when the machine is moving.

Operators need to have an idea of how much the load weighs before it is raised.

- Caution: If your machine feels unstable when the boom is raised and extended, always retract the boom before lowering it!

Chapter 6, Slides 20 – Load chart exercise.

Chapter 6, Slide 21 – Load chart review.

Chapter 6 Summary:

What was covered in Chapter 6?

- Various attachment options for lift trucks.
- Possible effects attachments may have on the operation of a lift truck.
- Potential hazards associated with using various attachments and how to control those hazards.
- The importance of acquiring additional training from a competent person on specific lift trucks, their attachments and their application at their worksite.

CHAPTER 7: BASIC OPERATION OF MOBILE EQUIPMENT

Goal:

The student should have a basic understanding of the operation of the most common lift trucks.

Objectives:

1. The student should have basic knowledge of operating Mobile Equipment equipped with forks.

Equipment operators are responsible for themselves, their machine and the people around them.

When handling various loads, it's easy to develop a narrow focus on the immediate job at hand.



Using Forks

- Forks are the horizontal bars that suspend from the carriage that engage and support loads.

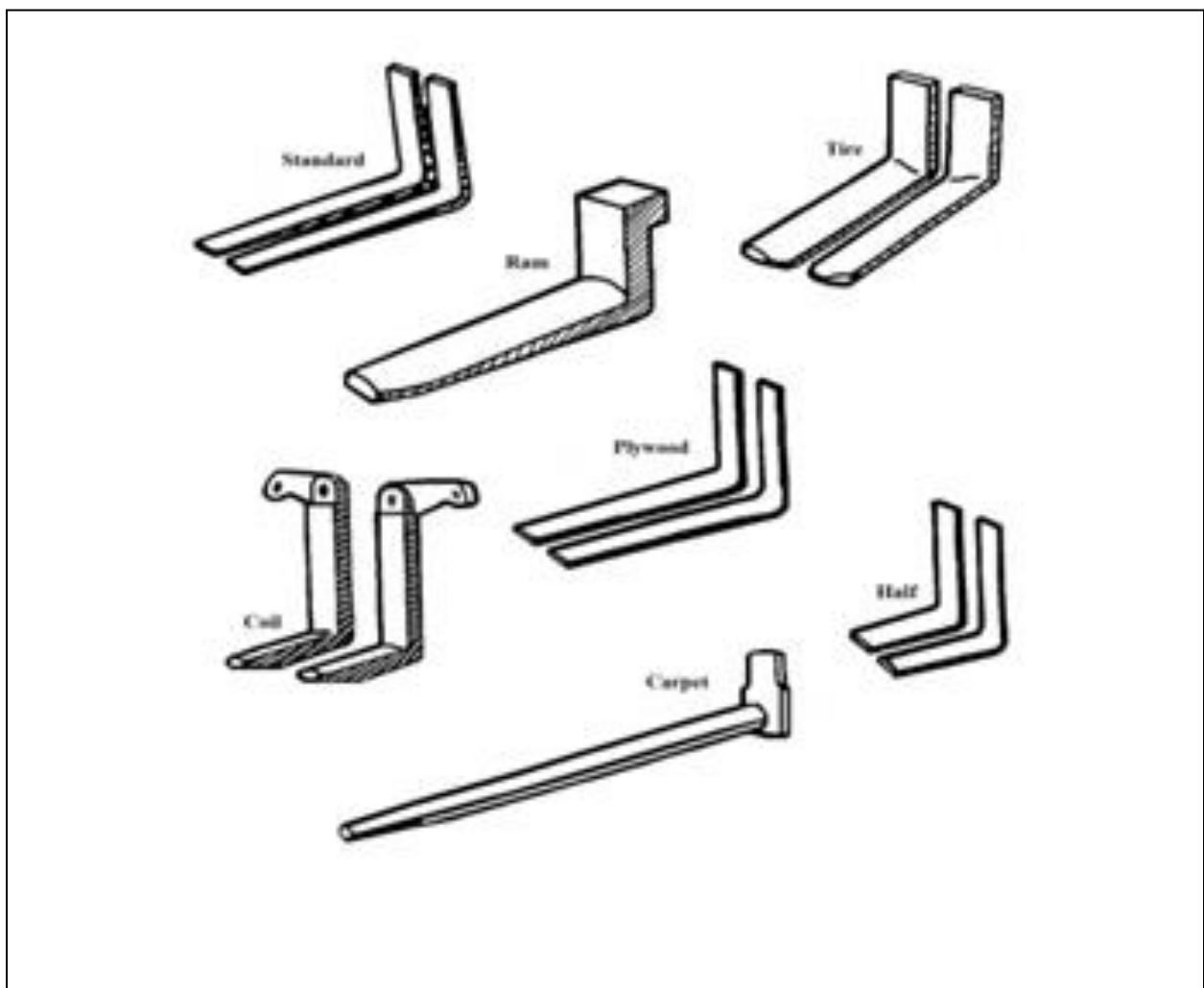

© Saga Universal Training Corp 2021

- Generally, forks are used in pairs, and are therefore required to have a rated capacity of at least $\frac{1}{2}$ the manufacturer's rated capacity of the machine.
- This means that each fork is expected to be able to carry half of the expected weight of the load.
- This also considers the rated load centre distance shown on the equipment's capacity plate.

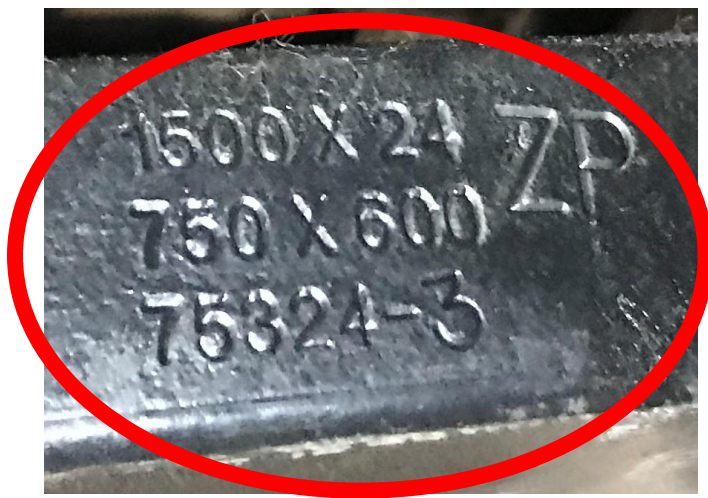

1500 lbs @ 24"
750 kg @ 600mm

Fork Locking Latch

- Locking latches are designed as a component of the forks to prevent movement from the set positions on the carriage.
- The locking latches can be of several different designs, often they are spring-loaded and require the operator to lift the latch or pin and slide the fork to the new locking position.

Fork Locking Latch



Carriage

- Carriages are the support structure for the forks and other attachments.
- The rated capacity of the carriage depends on the loads and types of attachments used.
- The carriage is often mounted to the mast by chains, rollers, and stops that allow it to move vertically in the designed channels.

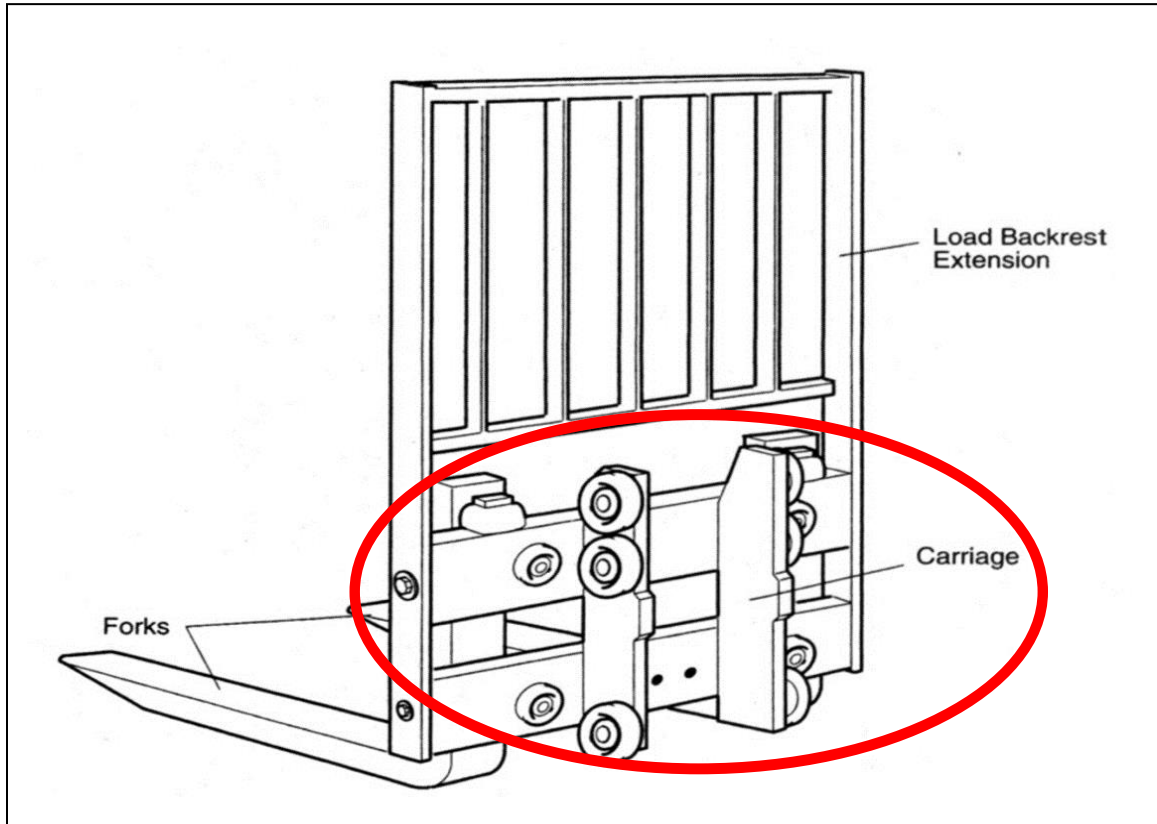

The carriage provides the connection between the load carrying devices (Forks) and the lifting device (Mast or boom).

Load Backrest Extension

- An extension that attaches to the carriage, provides support, and stabilizes the load above the carriage.

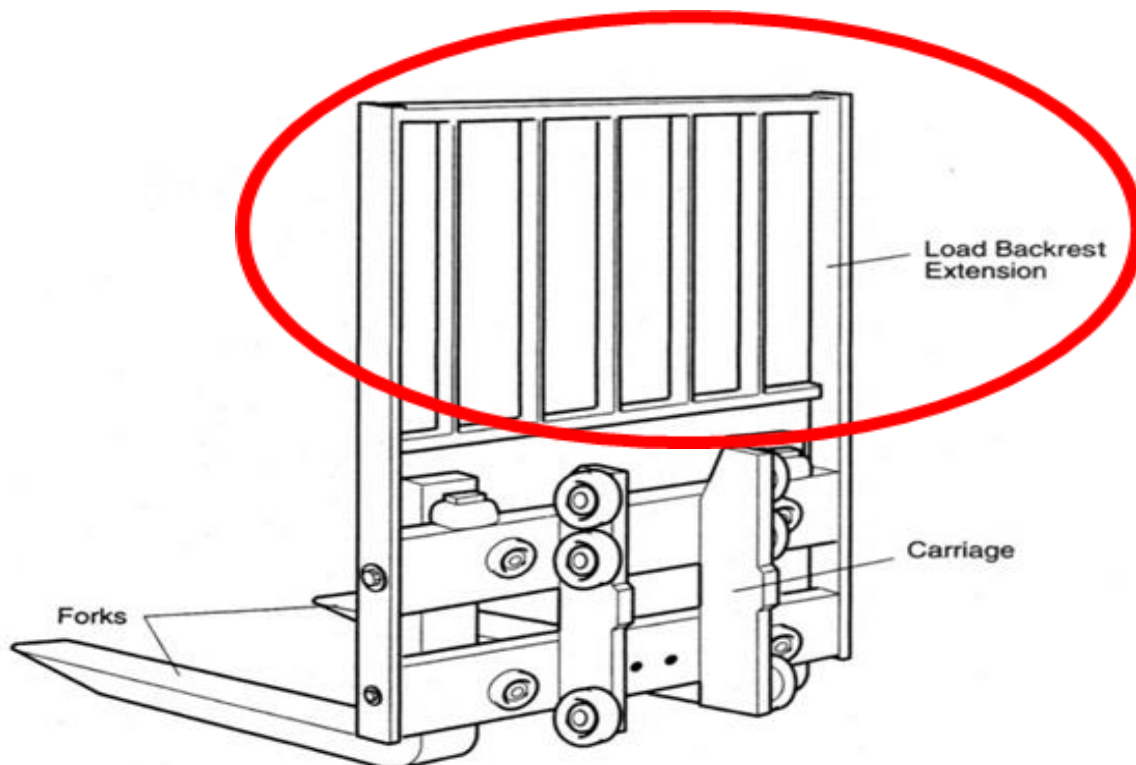

Fork Position

It may be difficult to get the ideal fork position on all loads due to different sizes, weights, and lengths of loads.

In order to maintain the capacities of the forks it is important to position them properly.

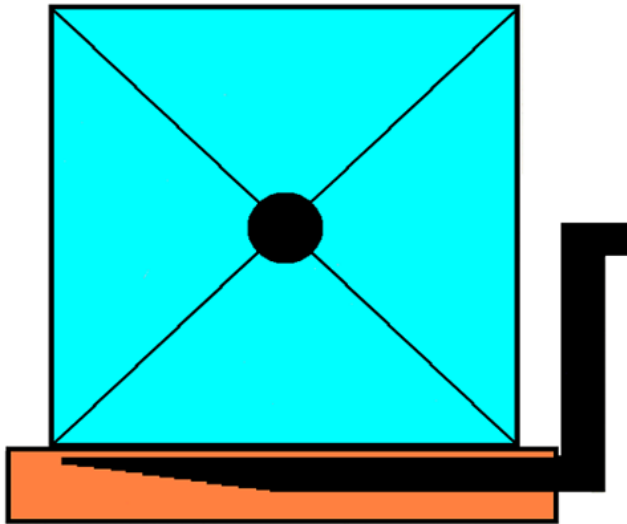

1. Forks should not protrude beyond the pallet.

2. Pallet should be SQUARE & to the back of the forks.

3. Forks should be level with the floor or tilted to secure.

Incorrect Fork Placement

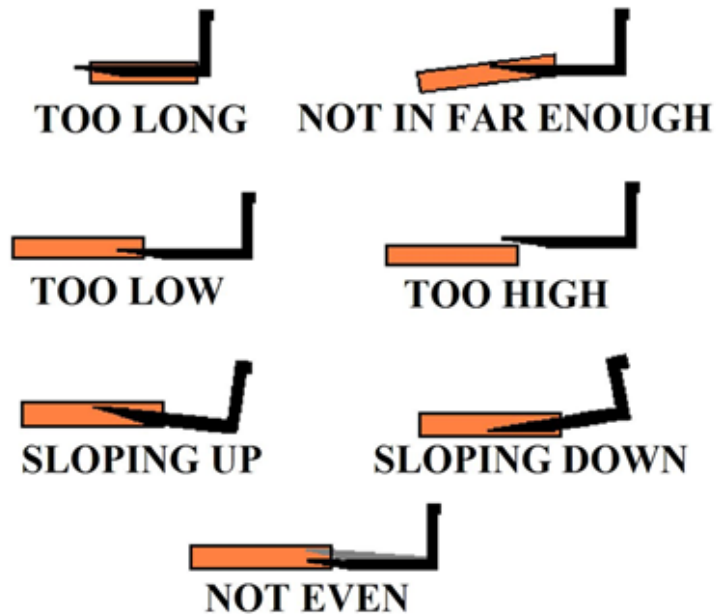

Loading Racks

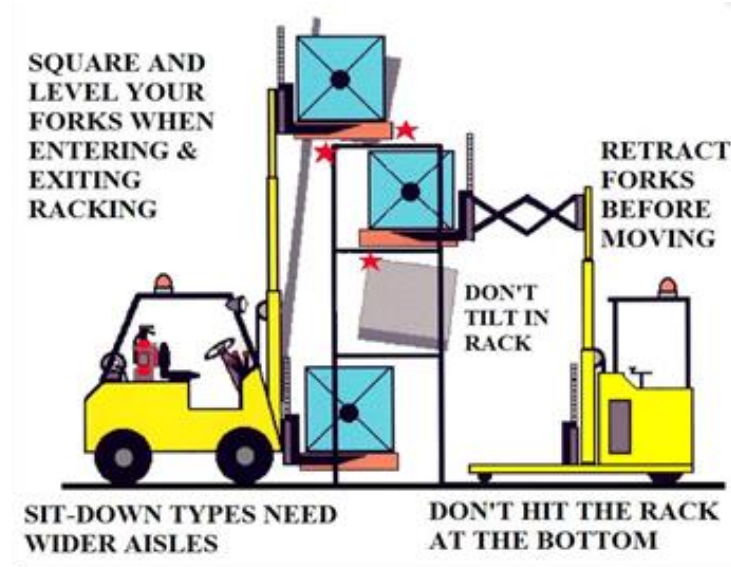

Keep in mind that racks should be designed and built for the intended capacities.

Many racks need to be bolted to the floor and the locking pins should be in every rail to prevent unnecessary detachment.

Racks can pose a hazard to the equipment operator; it is important to take great care in moving loads in and out of racks.

The clearances are small and in the event of damaging a rack the results could be catastrophic.

Keep in mind the rear swing of the forklift, watch for racks or obstacles behind you.

Watch the top clearance, ensure the load will fit in the rack.

On the sit-down type of forklift, drive forward slowly making sure that you still have your clearance space.

With the reach type of forklift, extend the load into the rack, again making sure that you still have clearance.

Caution, watch for short pallets that don't reach both beams of the rack, you may need to re-pallet the load to a larger pallet.

Reduce your speed, as you get closer to the empty rack.

Turn your forklift so that it is square with the rack.

Make sure that your mast is in the vertical position.

Raise the load a little higher than the empty rack.

Lower the load until the pallet rests on the rack completely.

Remove the forks by backing away or retracting the reach type.

Lower the forks and maneuver out of position.

For unloading do the reverse of the above.

Stacking

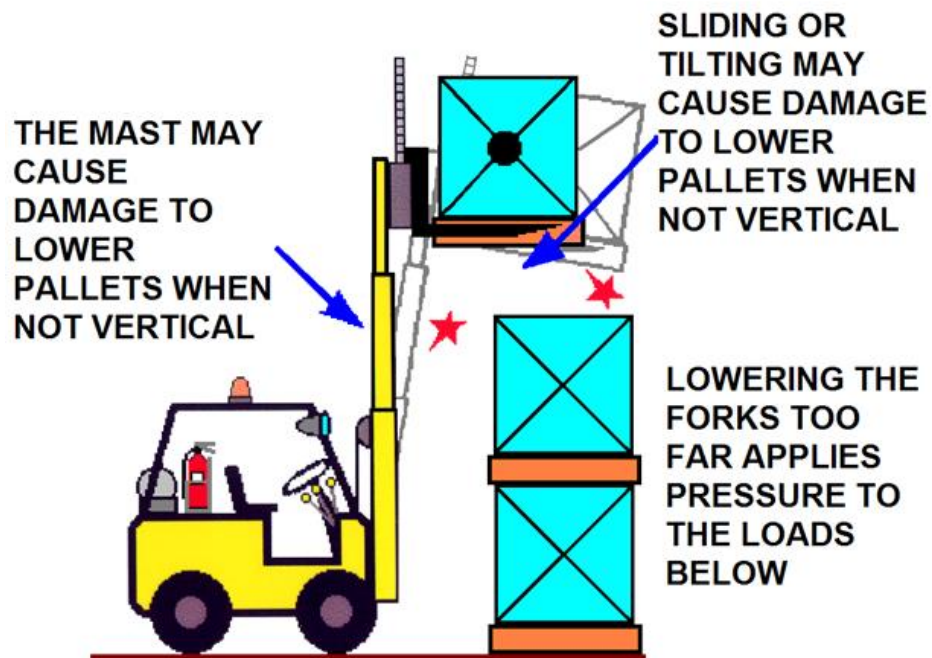

As an operator there are many hazards to be aware of when stacking loads.

If you are stacking loads on top of one another the operator needs to be sure that the loads underneath can support the added load.

The following is a list of steps on how to maneuver and stack a load safely.

Ensure that the bottom loads can support your new load.

Maneuver the forklift square and level with the other loads.

Raise the load up, about 10 – 15 cm (4-6 inches) above the stack. Watch for overhead obstacles such as ducts, pipes, wiring, and lights.

Move the load over the stack by driving forward or extending the reach.

Lower the load on the stack until the stack is supporting the weight of the load.

Retract or move the forks from beneath the load.

Lower the forks.

Maneuver away from the stack.

To remove a load from a stack, do the reverse of the above.

Most stacking errors are a result of the operator not being attentive, some things to watch for include:

The load is raised too high and hits overhead obstacles.

Unintentionally hitting the bottom of the stack causing damage or causing the loads above to collapse.