

# Confined Space Entry

BC OH&S compliant



# **First Edition (Version 1)**

**February 1, 2019**

**No part of this manual may be reproduced in any form or by any means, for any purpose without the express written permission**

**of:**

## **Saga Universal Training Corporation**

Saga Universal Training Corp. is dedicated to reducing deaths caused by illness and injury. This manual follows the guidelines, principles and recommendations established by the following WorkSafeBC, Publications: Occupational Health and Safety Regulation, Part 9 - Confined Spaces, Confined Space Entry Program – “A Reference Manual” and, Hazards of Confined Spaces, as well as internationally established and accepted safety standards including OSHA Standard 29 CFR Part 1910.146.

This training course is intended to supplement employer training programs. Readers should not assume that reviewing this manual alone constitutes complete Confined Space Entry training.

For further information contact:

***Saga Universal Training Corp.***

***E:mail – info@sagatraining.ca***

***Web Page – www.sagatraining.ca***

Saga Universal Training Corporation. wishes to acknowledge the efforts of all the people who contributed to the writing, editing, and layout of this manual. It is our hope that this manual and the resulting training program will aide in the reduction of preventable injuries with the necessary knowledge, skills and confidence to understand hazards associated with Confined Spaces.



# Table of Contents

Introduction.....	7
Section 1: General Requirements.....	8
Section 2: Responsibilities.....	17
Section 3: Hazard Assessment and Work Procedures.....	23
Section 4: Identification and Entry Permits.....	57
Section 5: Lockout and Control of Harmful Substances.....	61
Section 6: Verification and Testing.....	78
Section 7: Cleaning, Purging, Venting, Inerting.....	82
Section 8: Ventilation.....	92
Section 9: Standby Persons.....	96
Section 10: Rescue.....	100
Section 11: Lifelines, Harnesses and Lifting Equipment.....	106
Section 12: Personal Protective Equipment and Other Precautions .....	109
Glossary.....	117



# Introduction

A confined space can be found at almost any work site. Crawl spaces, cramped mechanical rooms, mezzanine areas, plumbing or electrical vaults, cargo containers and attic spaces can all fit within the definition of a confined space, depending on the design, access and work activities taking place.

Confined spaces have a history of being dangerous places to work as hazards within them are often magnified. Limited access may be combined with poor ventilation, hazardous surroundings or energized equipment. Workers unknowingly entering an oxygen deficient or toxic atmospheres, can be fatal.

Working in a confined space is potentially one of the most dangerous of all workplace hazards. According to the New Zealand Department of Labour, working in a confined space is 150 times more dangerous than doing the same job outside the confined space.

Accidents in confined spaces may be rare but they can result in severe injury and death. The majority of deaths in confined spaces are caused by hazardous atmospheres such as toxic gases or lack of oxygen. The remaining deaths are the result of physical hazards, where workers may be crushed, struck by falling objects, or buried in materials.

In British Columbia, Work Safe BC (the Workers' Compensation Board) reports 18 deaths in confined spaces over a 15-year period. Some of the incidents resulted in the death or injury of several workers, including those trying to rescue the first worker in distress.

Workers must not enter a confined space until hazards have been identified, workers are trained, and all procedures to eliminate or control the hazards are implemented. A confined space entry program for your workplace will describe what needs to be done before workers can safely enter and work in a confined space.

This course is designed to introduce the learner to the basic concepts, hazards, hazard control processes and safe work procedures associated with confined spaces; it is not a substitute for specific training needed before entering a confined space. WorkSafe BC's Occupational Health and Safety Regulation - Part 9, Confined Spaces, sets out specific requirements that apply to confined space entry.

It is expected that a workplace will apply this information as they create their own company specific confined space entry program.

# Section 1: General Requirements

This section outlines how to identify confined spaces and what to do when you have identified such spaces in your workplace.

## Learning Objectives:

1. Identify the 4 main characteristics of a confined space.
2. Identify the elements of the Exclusion Criteria for Enclosed Spaces.
3. Become familiar with the concept of Prohibited Entry.
4. Become familiar with the concept of Control of Hazards.
5. Become familiar with the elements of a Confined Space Entry Program.

## **9.2 Initial determination**

### **Legislation states,**

The employer must

- (a) ensure that each confined space in the workplace is identified, and
- (b) determine whether any such space will require entry by a worker, either in scheduled work activities or as a result of foreseeable system failures or other emergencies.

### *Related Guidelines:*

*Compliance will require a site inspection/survey. The results of the inspection/survey are then used as the basis for action under sections 9.3 to 9.5, depending on whether workers must enter the confined space or not.*

### Reference:

### **Listing the confined spaces in your workplace**

The employer must identify and make a list of each confined space in the workplace. Similar spaces may be grouped together. This list forms the basis of the hazard assessment and safe work procedures that the qualified person must prepare for confined spaces.

### **Stop!**

In every space, even those that are not considered to be confined spaces by definition, a harmful or fatal exposure can occur from breathing the atmosphere.

A worker's head (breathing zone) crossing the plane of an opening can result in the worker being exposed to a harmful or fatal concentration of contaminant.



Section 9.1 of the *OHS Regulation* ("*Regulation*") states:

"*confined space*", except as otherwise determined by the Board, means an area, other than an underground working, that

**(a) is enclosed or partially enclosed,**

The word "confined" may seem to imply only a small, tight, fully enclosed space. This is not true about all confined spaces in the workplace. They can be large or small and may not be enclosed on all sides. Even if workers can move freely inside the space and the space is only partially enclosed, it may still fit the definition of a confined space.

**(b) is not designed or intended for continuous human occupancy,**

As confined spaces are not designed or intended for continuous human occupancy, they are not sites of regular or ongoing work activity. Workers usually enter a confined space for purposes such as inspection, maintenance, repair, or construction. This often means the space is not normally ventilated and may have an atmosphere that is not safe to breathe.

**(c) has limited or restricted means for entry or exit that may complicate the provision of first aid, evacuation, rescue or other emergency response service, and**

Entry points may not be designed for easy walk-in. Other limitations include access by permanent or temporary ladders or by stairways that provide poor access because of restrictive slope, narrow width, or extreme length. Physical obstructions inside the space - such as bulkheads, collapsed material, or machinery – may impede exit. Limited means of entry and exit not only make escape or rescue difficult but can also restrict natural ventilation.

**(d) is large enough and so configured that a worker could enter to perform assigned work;**

A space that is too small for a worker to enter is not a confined space. For example, a narrow space between two walls may be an enclosed space, but unless the worker can fit inside the space, it is not considered a confined space, even if the worker can get a hand or foot into the space. Keep in mind that an enclosed space may still have hazards, atmospheric or otherwise, that need to be addressed.

In the case of a space that has been identified as a confined space, a person is considered to have entered the space as soon as they place their head (breathing zone) across the plane of the opening.

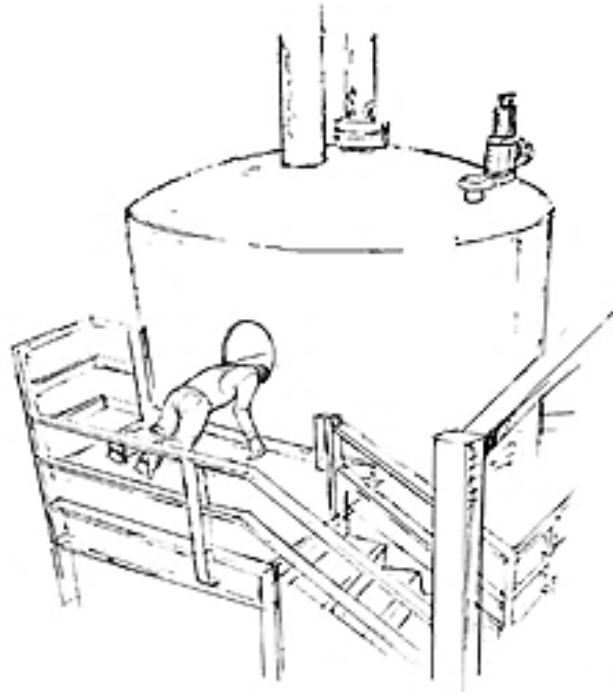

**Examples of confined spaces include:**

Tanks	Pipelines	Pits, sumps
Boilers	Sewers	Vessels
Vats	Manure pits	Manholes
Kilns	Storage bins	Other similar places
Vaults	Double hulls	
Silos	Pumping stations	

Think about your workplace and find out whether there are any confined spaces. Employers may need to rely on a qualified person to ensure all confined spaces have been identified.

Each situation may be different for each confined space in your workplace. Go through each of these four characteristics and see if the space you are thinking about fits each description. The space is only considered to be a confined space if it has all four characteristics. If you are not sure whether the space is considered to be a confined space, consult a qualified person.

Even if a space does not fit this definition, be aware that it may have other hazards that need to be assessed and controlled before workers can enter. For example, a space may have a toxic atmosphere even if it does not fit the definition of a confined space because entry and exit are not limited or restricted.

*Related Guidelines:*

*The definition of confined spaces in section 9.1 of the Regulation permits WorkSafeBC to determine certain spaces to not be confined spaces for the purposes of the application of Part 9 of the Regulation. The purpose of this guideline is to identify the types of spaces that WorkSafeBC has determined, as contemplated by the above definition, not to be confined spaces, and the criteria the employer must assess to exclude them. Also, it outlines the process for making the determination for other spaces.*

**Exclusion Criteria**

*Enclosed spaces that are not "confined spaces" for the purposes of the application of Part 9 must satisfy specific exclusion criteria.*

*To determine that a space is not a confined space, it must be identified as a space described in Column A and must meet all the criteria in Column B.*

<p style="text-align: center;"><b>Column A</b></p> <p>Spaces that may be excluded from Part 9, provided that <b>all</b> the criteria in Column B are met</p>	<p style="text-align: center;"><b>Column B</b></p> <p>Exclusion criteria</p>
<ul style="list-style-type: none"> <li>• Swimming pools</li> <li>• Crawl spaces under school portables or other non-industrial buildings</li> <li>• Excavations</li> <li>• Attic space</li> <li>• Open, unconnected wet wells or dry wells for storm or sewer hookups at new construction sites</li> <li>• Elevator shafts</li> <li>• HVAC plenums</li> <li>• Agricultural feed mixer wagons and trucks that are permanently open on top, and empty</li> </ul> <p>Note: Underwater spaces during occupational diving operations have special considerations, refer to <a href="#">section 24.17</a> of the <i>Regulation</i>, Safe diving procedures.</p>	<ol style="list-style-type: none"> <li>1. The design, construction, location, and intended use of these spaces will ensure these spaces are characterized by clean respirable air at all times.</li> <li>2. The space must have an interior volume of not less than 64 cubic feet per occupant.</li> <li>3. The space must have openings to the atmosphere that are known to provide natural ventilation.</li> <li>4. There must be no potential for a high or moderate hazard atmosphere, as defined in section 9.1 of the <i>Regulation</i>, to exist or develop immediately prior to any worker entering the space or during any work within the space.</li> <li>5. There must not be a need to mechanically ventilate, clean, purge, or inert the space prior to entry for any reason.</li> <li>6. There must be no potential for a hazardous substance to migrate through any media (e.g., air, soil, conveyance, piping, or structure) to infiltrate the space.</li> <li>7. The space must be free of residual material (e.g., waste, sludge, debris) that if disturbed could generate air contaminants that could immediately and acutely affect a worker's health.</li> <li>8. There must not be any risk of entrapment or engulfment to workers entering the space.</li> <li>9. The space must not contain, have introduced, or be adjacent to tools, equipment, or involve processes that could generate air contaminants that could immediately and acutely affect a worker's health.</li> </ol>

Where all the exclusion criteria are met, an employer through consultation with a worker, worker health and safety representative, or joint committee may make a determination that the space is not a confined space for purposes of Part 9 of the Regulation, and document that decision. The employer is expected to have suitable knowledge and expertise in confined space identification and assessment otherwise the assistance of a qualified person should be sought.

### **9.3 Prohibited entry**

#### **Legislation states,**

If a confined space exists at a workplace but no worker entry is required, the employer must ensure that each point of access to the confined space is secured against entry or identified by a sign or other effective means which indicates the nature of the hazard and the prohibition of entry, and that workers are instructed not to enter.



#### *Related Guidelines:*

*In some circumstances, use of signs or securing a confined space may be impracticable. Examples of "other effective means" of identification are colour coding and mapping of locations on plans, or using descriptors of covers, manholes and inspection ports in worker education.*

*The end result should be that workers are able to identify all confined spaces at their workplace, understand the hazards of these spaces and any prohibition of entry. Hazardous areas not intended to be accessible to workers should be secured as required by section 4.34 of the OHS Regulation. For example, a sewer manhole on a road has a cover that is heavy and usually requires a tool for removal, thus it is generally secure against entry by anyone without an appropriate tool to lift the lid off.*

#### Reference:

#### **Identifying confined spaces by a sign or other effective means**

Many workers do not realize they are entering a confined space. Employers must ensure all workers are given adequate instruction and training on the location of each confined space and requirements for entry into the confined space in their workplace.

When a worker is required to enter a confined space, each point of access that is not secured against entry must be identified by a sign or other effective means to indicate the hazard and prohibit entry by unauthorized workers.

## **Secured against entry**

Possible ways to secure against entry include a piece of metal across the opening or requiring special tools to remove the cover.

## **Identified by a sign**

A sign must indicate that the entrance marks a confined space, that there is a danger, and that entry is only permitted by authorized persons.

## **Other effective means**

A combination of instructions and marking a space may be effective. For example, tie hazard tape across the entrance and instruct workers not to go beyond the hazard tape without authorization.

If no worker entry is required, secure each access point to prevent entry.

## **9.4 Control of hazards**

### **Legislation states,**

The employer must ensure that all confined space hazards are eliminated or minimized, and that work is performed in a safe manner.

#### *Related Guidelines:*

*This may require the employer to take measures in addition to the other requirements of [part 9](#). The employer should consider alternative ways of doing the work that avoid or reduce the need to enter a confined space. For example, increasing the interval time between entries to perform routine maintenance in a confined space may be a way to reduce the overall total time workers must work in the space. New methods may eliminate or substantially reduce the need for a worker to enter a confined space. For example, consider an in-place cleaning system for tanks, such as brewery tanks, that flushes and cleans the tanks automatically. If either of these alternatives is practicable, they should be considered.*

## **9.5 Confined space entry program**

### **Legislation states,**

Before a worker is required or permitted to enter a confined space, the employer must prepare and implement a written confined space entry program which includes:

- (a) an assignment of responsibilities,

(b) a list of each confined space or group of similar spaces and a hazard assessment of those spaces, and

(c) written safe work procedures for entry into and work in the confined space, that address, where applicable

- (i) identification and entry permits,
- (ii) lockout and isolation,
- (iii) verification and testing,
- (iv) cleaning, purging, venting or inerting,
- (v) ventilation,
- (vi) standby persons,
- (vii) rescue,
- (viii) lifelines, harnesses and lifting equipment,
- (ix) personal protective equipment and other precautions, and
- (x) coordination of work activities.

*Related Guidelines:*

*Section 9.5 of the OHS Regulation requires the employer to have and implement a written confined space entry program before a worker is required or permitted to enter a confined space. The section sets out detailed requirements for the program, which are largely the matters covered by the other sections in part 9 of the OHS Regulation.*

*Aspects that should be addressed in the program and worker training are:*

- *a worker in a confined space is to immediately leave the confined space on being instructed by the standby person of a health or safety concern, and*
- *adequate procedures for preparing for entry into a confined space (for example, to cover the risk of dangerous contaminants flowing out of the entrance to the confined space when it first opened), as well as procedures for working inside the space.*

*Paragraph 9.5(c) specifies a list of topics to be addressed, where applicable, for each of the hazards identified under sections 9.9 and 9.10. Subparagraph (x) refers to "coordination of work activities". Coordination will be necessary if there are activities, either inside or outside the confined space that could affect the health and safety of any worker inside the space. Where the activities involve workers of more than one*

*employer, section 3.3 of the OHS Regulation applies, and in the case of a "construction project", section 20.3.*

Reference:

A **written** confined entry program is a requirement of the Regulation. The program identifies who has responsibility for confined space entry and a general description of how confined spaces are dealt with in your workplace. The program should identify who must be trained, the type of training required, and the frequency of training. This specific information is necessary to ensure that all workers understand the requirements for entering a confined space.

As you review this training program, take note of what is required in a confined space program and think about who will be carrying out each of the necessary tasks. This is the primary benefit of a written program. It clearly identifies each element in the management of confined spaces and also identifies those responsible for each requirement.

A confined space entry program is ongoing and will need to be revised as the workplace and work activities change.

The written program must be implemented to be effective, this means that workers must be trained, the required equipment must be provided, and all work procedures must be followed.



# Section 2: Responsibilities

This section outlines the employer's responsibilities to develop and implement a confined space entry program; who is qualified to do a hazard assessment and develop written procedures, and what is typically included in a worker education and training program. It does not cover all the information needed to develop a confined space entry program, but it will make the employer and worker aware of what their responsibilities are and when the qualified person is needed.

## Learning Objectives:

1. Identify which individuals are qualified to prepare the hazard assessment and written procedures for a Confined Space Entry Program.
2. Describe the knowledge and skills workers must be able to demonstrate after completing a training program for Confined Space Entry.
3. Be familiar with the frequency of training for Confined Space Entry.

## **9.6 Administration**

### **Legislation states,**

The employer must assign overall responsibility for administration of the confined space entry program to a person or persons adequately trained to do so.

### *Related Guidelines:*

*The administration of the program required by section 9.5 may be undertaken by the employer's own staff, or it may be assigned to another person or persons. The person(s) appointed responsible for administration of the program must be given the authority and means to ensure the effective operation of the program.*

### Reference:

### **Employer responsibilities**

The employer is responsible for preparing and implementing a written confined space entry program which includes:

- Assigning **responsibilities** for ensuring requirements are met (for example, a list of the responsibilities assigned to specific job titles)
- Listing each confined space or group of similar spaces and ensuring that there is a **hazard assessment** of those spaces. The hazard assessment must be prepared by a qualified person.

- Selecting the qualified person who is competent to provide a hazard assessment and safe work procedures.

The employer must ensure that all confined space hazards are eliminated or minimized, and that work is performed in a safe manner. There may be ways to do the work from outside the space or finding ways to reduce the time workers spend inside the confined space. For example, a system for flushing and cleaning tanks automatically may be practicable. Some employers have installed remote control cameras inside spaces to provide inspection of hard-to-see areas, which helps to eliminate or reduce the need for entry.

### **Who is qualified to prepare the hazard assessment and written procedures?**

The following qualifications are acceptable as evidence of adequate training and experience:

- Certified industrial hygienist (CIH)
- Registered occupational hygienist (ROH)
- Certified safety professional (CSP)
- Canadian registered safety professional (CRSP)
- Professional engineer (P.Eng.)

Provided that the holders of these qualifications have experience in the recognition, evaluation, and control of confined space hazards.

Others who have experience working with confined spaces and have a combination of education and training acceptable to WorkSafeBC may qualify to prepare the hazard assessment and written procedures.

The employer must exercise due diligence in the selection of the qualified person to undertake the hazard assessment and production of confined space procedures. Whenever a seriously deficient confined space hazard assessment or work procedure is encountered, this is an indication the author was not qualified to do the hazard assessment and/or develop the written confined space entry procedures.

The administrator's duties generally include liaison with the joint health and safety committee, with management, and with the qualified person writing the safe work procedures. This will ensure the procedures are implemented as written and the equipment is available. The administrator's duties also include evaluating the effectiveness of the program and ensuring changes are made if required.

## 9.7 Supervision

### Legislation states,

- (1) The employer must assign responsibility for supervision to a person who is adequately trained to supervise the job before any worker enters a confined space.
- (2) The responsible supervisor must ensure that
  - (a) pre-entry testing and inspection is conducted based on the written procedures,
  - (b) the precautions identified in the written procedures and the precautions required by this Regulation or which are otherwise necessary for the health and safety of workers are followed, and
  - (c) only authorized workers enter a confined space.

### *Related Guidelines:*

*Section 9.7 requires the supervision of a worker entering or working in a confined space. Section 9.7(2) describes some specific duties of the supervisor. Section 9.6 requires the employer to assign someone responsible for the administration of the employer's overall confined space program. This division of responsibility may require the program administrator(s) and the supervisor(s) to carry different levels of authority within the program for its efficient operation. The administrator may also fulfill the responsibilities of the supervisor. This may be the case in smaller operations.*

### Reference:

The person responsible for supervising the entry must be adequately trained before any worker enters a confined space. The supervisor of the entry typically is responsible for ensuring that the following are done for each entry at that site:

- Entry does not occur unless absolutely necessary.
- Pre-entry testing and inspections are conducted according to written procedures.
- The precautions and control measures identified in the written safe work procedures are in place and are being followed.
- Other precautions not directly related to the confined space entry but required by the Occupational health and Safety Regulation, such as traffic control, are in place and are being followed.
- Only authorized, trained workers enter a confined space.
- An entry permit is completed and posted at the entry to the confined space, where required.

- Workers are removed from the space and the adequacy of the work procedures are reviewed if changes occur during that affect the safety of workers.

## **9.8 Instruction**

### **Legislation states,**

Each person who is assigned duties or responsibilities related to entry into a confined space must be adequately instructed and trained in

- (a) the hazards of the space, and
- (b) the precautions identified in written procedures to properly perform their duties.

### *Related Guidelines:*

*Section 9.8 of the OHS Regulation requires that all persons who are "assigned duties or responsibilities related to entry into a confined space must be adequately instructed and trained". Specific training is required for persons contributing to the work activity, even those not entering the confined space, for example, standby workers and rescue workers.*

### Reference:

Specific instruction and training must be given to those who enter a confined space as well as those contributing to the work activity but not entering the space, such as standby workers and rescue personnel.

Workers must be trained in:

- Hazard of the confined space
- Written safe work procedures to safely perform their duties, including safe entry into the space as well as procedures for working inside

Workers must be trained to immediately leave the confined space when the standby person indicates evacuation is necessary, when the continuous monitor goes off, or when any unsafe work environment develops.

**Instruction**, or education, often takes place in a classroom setting, where the worker must be able to demonstrate knowledge of the subject.

**Training** often occurs in a mock setting or simulated setting, where the worker must be able to demonstrate proficiency using specific procedures and equipment. (for example, the worker should be able to use a specific monitoring device, apply locks, place

ventilation equipment appropriately, use a radio or other communication device, and use rescue equipment.)

Base your education and training program on the specific hazards identified in the confined space. Workers attending the education portion of the program will be instructed on the types of hazards that may exist and the effects of exposure to those hazards. The training portion of the program should be comprehensive and include a section requiring the familiarization with the equipment required for entry. It is the responsibility of the employer to ensure the instruction and training are effective and that retraining occurs often enough for workers to remain competent.

Remember to keep records of all instruction and training and make them available, upon request, to a WorkSafeBC prevention officer.

The following sample training program outline is provided to give you information about the types of training required. This sample cannot be used for your workplace without ensuring specific hazards are covered. Specific workers must receive training according to their responsibilities – for example, rescue workers and workers who provide monitoring equipment will require additional training in those tasks.

### **Sample training program outline for confined space entry**

#### **Training objectives**

Training objectives describe the knowledge and skills workers must be able to demonstrate after completing the training program. The following is an example of a set of training objectives.

Workers who successfully complete this program will be able to:

- Identify a confined space, describe what it is, and explain its dangers
- Identify warning properties of harmful air contaminants and symptoms of overexposure
- Follow written procedures, including entry permits (where used)
- Use and respond to alarms on an air-testing device
- Follow isolation and lockout procedures
- Properly use mechanical ventilation systems, including knowing the appropriate placement of the outlet/inlet to the ventilator to maximize the movement of air into the space or contaminants out of the space
- Properly use personal protective equipment
- Properly perform a seal-check if a face-sealing respirator is required
- Communicate with standby person(s)
- Follow emergency exit and rescue procedures

## **Qualifications of instructors**

Instructors should have basic teaching skills and a thorough working knowledge of:

- Types of confined spaces at the worksite
- Hazards likely to be encountered, both atmospheric and physical hazards
- Specific work practices and techniques to be used in the space
- Appropriate ventilation for the work being done
- Duties and responsibilities of the supervisor of the entry, workers entering the space, and standby person(s)
- Monitoring requirements, including knowledge of monitoring equipment
- Spaces that require entry permits
- Safe limits for oxygen, flammable materials, and possible air contaminants
- Rescue procedures and equipment
- Health and safety requirements from other parts of the Regulation that apply, or the requirements for safe work procedures for limited or restricted visibility
- Selection, care, use, and maintenance of personal protective equipment.

## **Selection of trainees**

Train all workers involved with your confined space program. This includes:

- Workers who prepare a confined space for entry
- Workers who are required to enter a confined space
- Workers who test or monitor the atmosphere
- Standby persons
- Supervisors of any of the above
- Any worker who may be required as a back-up to already trained workers

## **Frequency of training**

Provide training whenever:

- Workers have not previously done confined space work
- New confined spaces have been added to your operation
- New job procedures, equipment, or controlled products are to be used in confined spaces
- Evaluation shows that workers who have received training are no longer able to apply such training (it may be necessary to redesign your training program if it is found to be ineffective)

# Section 3: Hazard Assessment and Work Procedures

This section describes what a hazard assessment is and who is qualified to prepare one.

## Learning Objectives:

1. Identify when a Hazard Assessment must be conducted.
2. Be familiar with the items a Hazard Assessment must consider.
3. Identify the 4 hazardous conditions that may exist in a Confined Space.
4. Identify the 4 categories that hazards in a Confined Space generally fall within.
5. Understand the ranking system for atmosphere within a confined space.
6. Understand the factors that cause oxygen deficiency.
7. Understand and identify the 3 elements required for a fire, or an explosion to occur.
8. Be familiar with how to make a Confined Space safe from physical hazards.
9. Identify different types of physical hazards.
10. Understand what is meant by the phrase, “not designed or intended for continuous human occupancy”.
11. Understand what is meant by the phrase, “restricted means for entry or exit”.
12. Understand what is meant by the phrases, “high hazard atmosphere” and “low hazard atmosphere”.
13. Be familiar with the information located in written safe work procedures which are included in a confined space entry program.
14. Be familiar with the concept of Testing the Atmosphere.
15. Be familiar with the 5 aspects of Testing the Atmosphere.
16. Identify the 3 elements to test for before entering a Confined Space.
17. Understand when to test the atmosphere in relation to a Confined Space.
18. Understand where to test the atmosphere in relation to a Confined Space.
19. Understand Employer Due Diligence as defined in Section 9.11 of the Regulation.

## **9.9 Hazard assessment**

### **Legislation states,**

- (1) A hazard assessment must be conducted for each
  - (a) confined space, or each group of confined spaces which share similar characteristics, and

(b) work activity, or group of work activities which present similar hazards, to be performed inside a confined space.

(2) The hazard assessment required by subsection (1) must consider

(a) the conditions which may exist prior to entry due to the confined space's design, location or use, or which may develop during work activity inside the space, and

(b) the potential for oxygen enrichment and deficiency, flammable gas, vapour or mist, combustible dust, other hazardous atmospheres, harmful substances requiring lockout and isolation, engulfment and entrapment, and other hazardous conditions.

#### *Related Guidelines:*

*The hazard assessment required by section 9.9 of the OHS Regulation must be performed by a "qualified person", as defined under [section 9.11](#). Once the assessment has been done for a specific activity within a particular space or group of similar spaces, it may provide the basis for procedures for every occasion when workers enter those spaces. On each such occasion, the circumstances of the proposed job should be considered beforehand by the supervisor (who need not be a "qualified person" under section 9.11) to ensure that the criteria or conditions upon which the hazard assessment is based remain substantially the same. If the conditions are different in a way that might affect the outcome of the hazard assessment previously done by a qualified person, then the circumstances should be reviewed and entry procedures revised as necessary, by a "qualified person". The assessment of a "qualified person" cannot be changed without the concurrence of the same or another "qualified person".*

*Paragraph 9.9(2)(b) states that the hazard assessment required under section 9.9(1) must consider a list of specific circumstances as well as "other hazardous conditions". In general, the conditions referred to here represent requirements addressed in other parts of the OHS Regulation. These include, but are not limited to, fall protection, hearing conservation, radiation, heat stress, extreme climactic conditions such as flooding from heavy rains, and lockout of equipment and processes.*

#### **G9.9-2 Visiting employers**

*The process of identifying confined spaces, assessing hazards and developing work procedures in a workplace is the responsibility of the employer who operates the business carried on at the workplace. However, employers commonly perform jobs at workplaces that they do not own or control. If an employer is sending a worker to another employer's or owner's operation, the following need to be considered to ensure the "visiting" employer meets their obligations under [Part 9](#).*



- 1. The visiting employer need not repeat the process of identifying and placing signs on confined spaces as required by sections 9.2 and 9.3 if this has already been done by an effective confined space entry program of the resident employer. The visiting employer should, however, inform its workers of the location and nature of any confined spaces that might affect their work and activities. The owner of a workplace, or the employer controlling a workplace, should provide this information. See also section 118 of the Workers Compensation Act and section 20.3 of the OHS Regulation.*
- 2. If a visiting employer does work that requires one of their workers to enter a confined space, the visiting employer must have its own confined space entry program under section 9.5. The program may be generic in nature covering the general types of confined spaces its workers would be expected to enter in the course of their visits to different sites. Such generic procedures would then be supplemented by specific procedures for the activity and confined space to be entered, which may be developed in conjunction with the resident employer or site owner. All persons with duties related to confined space entry must be trained in these specific procedures before any entry into a confined space.*
- 3. If a visiting employer is utilizing some aspects of the resident employer or owner's confined space entry program, the visiting employer must undertake sufficient hazard identification and risk assessment to ensure their activity will be in compliance if the host employer or owner's confined space entry program is used. For example, a contractor doing welding or painting may create hazards the owner's confined space entry program did not consider in their hazard identification and risk assessment.*

Reference:

**Preparing a hazard assessment**

The qualified person must prepare a hazard assessment for each confined space (or group of spaces) and for the work activities to be performed. The qualified person must have training and experience in recognizing, assessing, and controlling the hazards of confined space and must consult with the program administrator and the joint committee (or worker health and safety representative).

The employer must have a list of all confined spaces in the workplace. The employer may have the qualified person review the list to ensure all the confined spaces have been properly identified. For each confined space or group of similar spaces, the qualified person will identify potential hazards and assess the likelihood of each occurring.

The hazard assessment must consider conditions that may exist in the confined space (before the worker enters) due to design, location, and use of the confined space. The assessment must also consider the hazards that may develop during work activity in and around the confined space.

When conducting a hazard assessment, the qualified person must consider the potential for

- Oxygen enrichment or deficiency
- Flammable gas, vapour, or mist
- Combustible dust
- Other hazardous atmospheres

Based on this assessment, the qualified person will rate the confined space as low, moderate, or high-hazard atmosphere space. The employer must know the hazard rating because it affects the control measures selected, including level of standby services, entry permit requirements, and rescue.

The hazard assessment will also look at other potential hazards:

- Lines containing harmful substances requiring lockout and isolation
- Workers becoming engulfed or entrapped in materials
- Slipping or tripping hazards
- Drowning
- Exposure to noise
- Other hazardous conditions such as thermal extremes and radiation

#### **The difference between *engulfment* and *entrapment***

**Engulfment** results when a substance, liquid, or solid flows around a person and encloses them, hindering their ability to escape and often making it impossible for them to breathe because they become immersed in the substance. A sudden release of water into a confined space might cause engulfment. A sudden release of sawdust, or grain may also cause engulfment.

**Entrapment** can occur in any space that has an internal configuration such that an entrant could be trapped or asphyxiated by inwardly converging walls or by a floor that slopes downward and tapers to a smaller section.

Engulfment and entrapment are serious health and safety hazards that require the highest level of standby services, specific controls such as lifelines, and entry permit.

The qualified person will prepare a hazard assessment and develop written procedures to eliminate or minimize all the hazards likely to prevail. Once the assessment has been done for a specific activity within a particular space or group of spaces, it may provide the basis for procedures for every occasion when workers enter those spaces.

On each occasion, the supervisor of the entry should consider whether the circumstances of the proposed job are substantially the same as the conditions upon which the hazard assessment is based. If the conditions are different from those in the hazard assessment (for instance, if a worker is required to do hot work in a confined space and the hazard assessment and written work procedures were based on inspection of the space without any hot work), then the circumstances must be reviewed, and entry procedures revised as necessary by the qualified person.

### **When conditions change**

Work inside the space must not continue if the safe work procedure does not take changing conditions into account. Workers must exit the space. Workers must stay out of the space until required control measures for the changed condition are put into place. For example, the qualified person may have provided a hazard assessment and resulting written work procedures for “inspection of a confined space”. During the inspection, it may be discovered that repairs require welding inside the space. The hazard assessment and written work procedure for welding inside the space will be different than a written work procedure for inspection. Because a new set of conditions exist in the space, a new written procedure must be followed. The new written procedure must include control measures for welding fumes and all other associated risks.

### ***Hazards of confined spaces***

All confined spaces must be carefully assessed to identify every hazard. Many of these hazards can cause serious injury or death if they are not identified, assessed, and controlled. These assessments must be done by a qualified person familiar with the confined space and the work to be done in that space.

In addition to atmospheric hazards, confined spaces may also have physical hazards that may result, for example, in workers falling, being crushed or buried, or drowning. These hazards may not be obvious. Hazards in confined spaces generally fall within four categories:

- Atmospheric
- Safety
- Work-related
- Human factors

## **Atmospheric hazards**

The atmosphere in a confined space may be hazardous for several reasons. The air may have too little or too much oxygen. The atmosphere may be toxic or explosive. Pages 4–13 describe some of the dangers of hazardous atmospheres. Confined spaces with hazardous atmospheres could also have some of the physical hazards.

Once a confined space is identified, its atmosphere must be hazard-rated as **HIGH**, **MODERATE**, or **LOW**. The hazard rating of a confined space must be determined by a qualified person after considering the design, construction, and use of the confined space, the work activities to be performed, and all required engineering controls.

### **High-hazard atmosphere:**

An atmosphere that may expose a worker to risk of death, injury, or acute illness, or otherwise impair a worker's ability to escape unaided from a confined space if the ventilation system or respirator fails.

### **Moderate-hazard atmosphere:**

An atmosphere that is not clean, respirable air but is not likely to impair a worker's ability to escape unaided from a confined space if the ventilation system or respirator fails.

### **Low-hazard atmosphere:**

An atmosphere that is shown by pre-entry testing or is otherwise known to contain clean, respirable air immediately prior to entry into a confined space, and that is not likely to change during the work activity.

### **Oxygen: too little or too much**

Lack of oxygen is a leading cause of death among workers entering confined spaces. Low oxygen levels cannot be detected by sight or smell. You must test the air for this hazardous condition. A very low level of oxygen can damage the brain and cause the heart to stop after a few minutes.

### **What causes oxygen deficiency?**

Here are some common causes of oxygen deficiency (not enough oxygen) in a confined space:

- Oxygen is used up when metals rust.
- Oxygen is used up during combustion — for example, by propane space heaters, during cutting or welding, and by internal combustion engines.

- Oxygen can be replaced by other gases — for example, welding gases or gases forced into the space to prevent corrosion.
- Micro-organisms use up oxygen — for example, in sewer lines and fermentation vessels.

Too much oxygen is not as common a hazard as low oxygen, but it is also dangerous. Too much oxygen greatly increases the risk of fire or explosion in the confined space. Materials that would not normally catch fire or burn in normal air may do so extremely quickly and easily where there is a high level of oxygen.

The only way to know how much oxygen is present in a confined space is to use an oxygen monitor. The monitor must be in good working order and properly maintained and calibrated. The alarm must be set at the right level. Someone trained to use the monitor must test the air before anyone enters the confined space.

An oxygen monitor shows oxygen levels as a percentage of the air. Air contains 20.9% oxygen.

NOTE: As the elevation increases, the amount of oxygen in the air decreases. However, the percentage reading on the oxygen monitor does not change with elevation. Therefore, always consult with a qualified person to determine safe entry procedures. The qualified person will take elevation into account.

The monitor should be tested in clean outside air. If the reading is above or below 20.9% oxygen, there may be a problem with the oxygen sensor or with the calibration of the unit. Do not use this monitor for testing inside the confined space, and do not enter the confined space until a properly calibrated monitor is used.

Clean outside air contains 20.9% oxygen. If the air in the confined space is anything other than 20.9%, the reason should be investigated by a qualified person to ensure the space is safe to enter. It is vitally important to understand what is causing the change in oxygen level. The reason must be identified before workers are allowed to enter the space. For example, many toxic gases present a high hazard to workers even when the concentration is low enough to cause only a very small displacement of oxygen. With some common solvents, a 0.1% change in the oxygen reading could mean the presence of enough toxic gas to cause death or serious injury.

Working in an atmosphere with oxygen levels between 14% and 17% can produce impaired judgment, dizziness, fatigue, and collapse. In oxygen levels lower than this, the one breath you take could have so little oxygen that your muscles can't respond, and you won't have enough strength to escape even if you are still conscious.

Workers must not enter a confined space containing less than 19.5% oxygen without taking appropriate precautions, including the use of supplied-air respirators.

## **Toxic atmospheres**

Contaminants in the air can result in an atmosphere that is toxic to workers and may result in injury or death. Some toxic gases typically found in confined spaces are listed in the table on pages 31–32.

In the past, miners would take canaries down into coal mines, since these small birds react quickly to carbon monoxide, a deadly gas. If the canaries breathed a small amount of the gas, they would sway on their perches before falling. This gave miners warning that the deadly gas was present. Today, miners have monitors to let them know when there are toxic substances in the atmosphere.

The concentration of the substance inside the confined space must be determined using a recently calibrated and properly set up air monitor with the correct sensor. Such an air monitor may sound an alarm that will alert the worker before the allowable exposure limit is reached.

In most cases, mechanical ventilation such as fans must be used to ventilate the space, bringing in clean outside air. Additionally, the harmful substance must be eliminated wherever practicable. Air testing and ventilation are the best ways to ensure that workers are not placed at risk from hazardous atmospheres.

At certain concentrations, some substances become immediately dangerous to life and health (IDLH). At these levels, even a brief exposure can cause permanent health effects such as brain, heart, or lung damage. Or the substance may make workers dizzy or unconscious so that they cannot escape from the confined space. Some substances have very low IDLH levels. For example, the IDLH level for hydrogen sulfide is only 100 ppm (parts per million).

### **As a result of liquids and solids inside the confined space ...**

Liquids may produce hazardous atmospheres if they evaporate — for example, liquid fuel in a tank producing vapours. Dangerous conditions can develop when pockets of gas in waste materials are disturbed during cleaning. For example, an organic material such as manure sludge can release the toxic gas hydrogen sulfide when manure pits are cleaned out. Rotting pulp in tanks also creates hydrogen sulfide. If grains in silos ferment, they use up oxygen and produce deadly gases.

### **As a result of work done inside the confined space ...**

In one-third of accidents involving harmful gases or lack of oxygen, the danger was not present in the confined space when the worker first entered it. Rather, the work in the confined space created the hazardous atmosphere.

## Vapour Density

Vapour density is the weight of a gas (vapour) compared to air. Air (or hydrogen in some cases) is used as the medium and has a vapour density equal to one (1). If the gas has a vapour density **greater than** one (1) it will sink in air. Propane for example, has a vapour density of 1.5; therefore, propane will normally sink to the ground and seek low-lying areas. Hence the reason why propane powered vehicles are not allowed in underground parking garages. If the vapour density is **less than** one (1) the vapour will rise in air. An example is methane with a vapour density of 0.6.

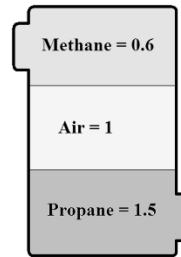

### Characteristics of Common Gases

Material	Flashpoint	Combustible Range	Physical Description	MAIN Danger	8 hr. TWA	IDLH	Density (Air =1)
Carbon Dioxide (CO <sub>2</sub> )	N/A	Non-Combustible	Colourless, Odourless	Displaces oxygen. Toxic	5,000 ppm	50,000 ppm	1.5
Carbon Monoxide (CO)	-191 °C	12.5 – 75%	Colourless Odourless	Toxic — asphyxiant	25 ppm	1,500 ppm	0.97
Chlorine (Cl <sub>2</sub> )	N/A	Non-Combustible	Greenish yellow colour; sharp pungent odour	Toxic — lung and eye irritant.	0.5 ppm	10 ppm	2.5
Diesel Fuel	37.8 °C	1 – 6%	Clear to yellow liquid	Flammable	15 ppm	600 ppm	.9
Unleaded Gasoline	-65 °C	1 – 7.6%	Colourless; sweet odour	Fire and explosion. Toxic – nervous system depressant	300 ppm	1100 ppm	3.5
Hydrogen Sulphide (H <sub>2</sub> S)	-82 °C	4 – 46%	Colourless; Sulfurous odour	Flammable Poisonous Caustic	10 ppm	100 ppm	1.2
Methane (CH <sub>4</sub> )	-188 °C	5 – 15%	Colourless Odourless	Fire and explosion	O <sub>2</sub> at 19.5%	20% of LEL	0.6
Nitrogen (N <sub>2</sub> )	N/A	Non-Combustible	Colourless Odourless	Displaces oxygen	O <sub>2</sub> at 19.5%	Displaces oxygen	0.97
Propane	-40 °C	2.2 – 9.5%	Colourless Cabbage odour	Flammable	1,000 ppm	20% of LEL	1.5
Sulfur Dioxide (SO <sub>2</sub> )	N/A	N/A	Colourless Sulfurous, suffocating odour	Toxic – severe lung irritant	2 ppm	100 ppm	2.2
Oxygen (O <sub>2</sub> )	N/A	Enhances combustion.	Colourless Odourless	L - asphyxiant H – enhances combustion	N/A	<19.5% >22%	1.2

Exposure deadens the sense of smell, which means you could be walking TOWARD rather than AWAY from the source and not know it.

NOTE: Combining chemicals may result in a toxic gas being released. Always read the SDS to get the information you need about mixing two products.

Activities that may lead to the release of harmful substances into the air include grinding, descaling, insulation removal, metal spray applications, rubber lining, painting, fibre-glassing, cutting, welding, and the use of internal combustion engines. Cleaning agents may be toxic, may react with tank residues, or may release a deadly gas from porous surfaces inside the space.

Cleaning a tank that contains dusts can cause the dust to become airborne and create a hazardous atmosphere.

### **As a result of contamination from outside sources ...**

A confined space may be located next to a source of a hazardous contaminant. The contaminant could enter the confined space through porous walls, such as those that may be found in sewers or trenches, or through difficult-to-seal openings such as conduits. Normally, mechanical ventilation is set up to bring outside air into the confined space. If the intake hose is located beside a running vehicle or equipment with an internal combustion engine, the intake hose brings in exhaust fumes.

### **Explosive atmospheres**

Three elements are necessary for a fire or explosion to occur: oxygen, flammable material (fuel), and an ignition source.

#### **Oxygen**

Air normally contains 20.9% oxygen, enough oxygen for a fire. However, a higher level of oxygen increases the likelihood of material burning. Air is considered oxygen-enriched at levels above 23%. Enrichment can be caused by improper isolation of oxygen lines, ventilation of the space with oxygen instead of air, or leaks from welding equipment.

#### **Fuel**

Fires and explosions in confined spaces are often caused by gases or vapours igniting. Coal dust and grain dusts may explode when a certain level of dust in the air is reached.

NOTE: Two or more chemicals may react with each other and become explosive.

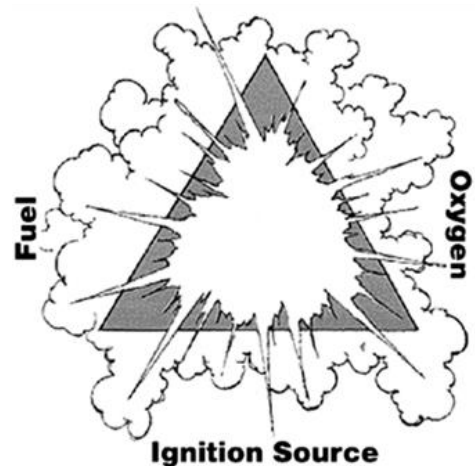



Containers of fuels such as gasoline and propane should not be taken into a confined space as fuel can easily burn or explode.

Here are some other common substances that can cause explosions or fires in confined spaces:

- Acetylene gas from leaking welding equipment
- Methane gas and hydrogen sulfide gas produced by rotting organic wastes in sewers or tanks
- Hydrogen gas produced by contact between aluminum or galvanized metals and corrosive liquids
- Grain dusts, coal dust
- Solvents such as acetone, ethanol, toluene, turpentine, and xylene, which may have been introduced into the space through spills or by improper use or disposal

A trained person must test the atmosphere for gases and vapours that will burn or explode. You cannot always see or smell these dangerous gases and vapours. If any measurable explosive atmosphere is detected, the air must be further evaluated by a qualified person to ensure that it is safe to enter the confined space.

### **Ignition sources**

Ignition sources include:

- Open flames
- Sparks from metal impact
- Welding arcs
- Arcing of electrical motors
- Hot surfaces
- Discharge of static electricity
- Lighting
- Chemical reaction

Many processes can generate static charge, including steam cleaning, purging, and ventilation procedures. To reduce the risks from these ignition sources, use non-sparking tools and ensure all equipment is bonded or grounded properly.

## **Gases that may be in your workplace**

Exposure deadens the sense of smell, which means you could be walking TOWARD rather than AWAY from the source and not know it.

NOTE: Combining chemicals may result in a toxic gas being released. Always read the Material Safety Data Sheet to get the information you need about mixing two products.

## ***Making the confined space safe from physical hazards***

This section covers the information on minimizing entrapment, engulfment, and crushing hazards, and information on using controls such as lockout, isolating piping, and electrical safety.

Physical hazards must be identified and controlled to make sure the space is safe for workers to enter. The qualified person will have identified all physical hazards in the hazard assessment and will have provided the required precautions and written procedures to control those hazards (including lockout and isolation). The supervisor of the entry must verify that all required precautions are in place before any worker enters a confined space.

There are many types of physical hazards, including crushing hazards, heat and cold stress, radiation, vibration, and noise. Confined spaces with a hazard of entrapment or engulfment and any situations requiring lockout or isolation procedures should be considered a very serious hazard. In these cases, an entry permit is required. A risk of engulfment or entrapment requires the highest level of standby service.

## **Loose and unstable material**

Whenever unstable solids made of small particles like sand or grain are stored in enclosures, there is a danger of the materials flowing onto workers and trapping or burying them. Examples of these confined spaces are sand bins, wood chip or sawdust bins, storage or grain silos, and potash feed systems.

Granular materials, particularly if moist, can form bridges (or shoulders) above workers. If jarred, these can collapse onto a worker.

Bins and hoppers in which materials are conveyed or augered into the bin are particularly dangerous. A worker may be trapped or crushed when material is accidentally discharged into an empty bin or hopper.

The design of these confined spaces may increase the danger of being trapped or buried. For example, in an empty hopper with a floor that slopes steeply to a vertical chute, a worker can slide into the chute and become trapped there.

Wherever there are loose, unstable materials that could trap or bury you, a qualified person must inspect the space and assess the hazards. Do not enter until the hazard has been eliminated or controlled. Specific training and safety precautions must be in place before you enter.

If entry is necessary, the qualified person will provide a written procedure. The written procedure will consider the following:

- Inspection prior to entry
- Use of kickers or probe bars to dislodge bridges and hung-up material prior to entry
- De-energization and lockout of all operating process equipment inside the confined space prior to entry
- Isolation and/or lockout prior to entry to prevent engulfment
- Requirement for lifeline and harness and provision for immediate rescue of a worker in distress
- Other protective equipment that may be needed, such as personal flotation devices or fall protection

### **Slip, trip, and fall hazards**

The space you are about to enter may have a hatchway that is difficult to squeeze through, and ladders for ascending or descending. You are therefore at risk of falling while getting into the space as well as while you are inside. In addition, the flooring of tanks or other wet environments or the rungs of a ladder may be very slippery.

If the hazard cannot be eliminated and there is a danger of falling from a height, a fall protection system (such as guardrails or a harness and lifeline) may be needed.

### **Falling objects**

In a confined space there may be the danger of being struck by falling objects such as tools or equipment, particularly if access ports or workstations are located above workers. If workers might be exposed to the hazard of falling objects, safe work procedures must be put in place to prevent this.

Where workers could be exposed to danger from falling objects, follow these requirements:

- Schedule work activity so that no worker is working above another
- Lower equipment and tools into the space before workers enter and remove them after workers leave the space
- Provide suitable protection from overhead hazards
- Provide workers with safety headgear

It is the employer's responsibility to provide all required personal protective equipment and ensure that workers are trained to use it.

### **Moving parts of equipment and machinery**

Mechanical equipment such as augers, mixers, or rotating tanks can be dangerous if activated or not secured. Residual energy, such as gravity or accumulated pressure, may also pose a risk unless the equipment is locked out and de-energized. This must be done by following a written lockout procedure that is specific for each piece of equipment and that states each place where a lock must be applied. Even when the power is shut off and the equipment is locked out at control points, unsecured equipment can move, especially if it is out of balance.

Before doing any work in confined spaces:

- Shut the power off
- Ensure that the equipment is locked out at control points
- Test the lockout
- Secure any equipment that can move, even when it has been locked out

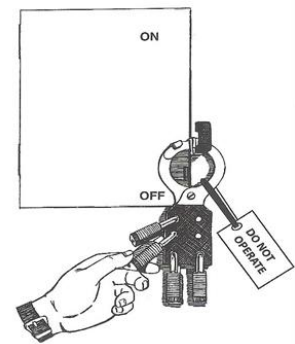

### **Electrical shock**

Electrical shock can result from defective extension cords, welding cables, or other electrical equipment. Work done in metal enclosures or in wet conditions can be particularly dangerous. Install ground fault circuit interrupters (GFCIs) or use assured grounding where there may be a danger of electrical shock. All electrical sources that pose a hazard to workers inside the space must be locked out following the written lockout procedure for the particular confined space.

See Guideline 9.18(3)(b) for more information.

### **Substances entering through piping**

Piping adjacent to a confined space could contain liquids or gases or other harmful substances. If these substances enter the confined space, the hazards may include:

- Toxic gases
- Burns from hot substances
- Drowning
- Being trapped, crushed, or buried

Substances must be prevented from entering the confined space through piping. This is done by "isolating" the piping from the confined space. The method often involves disconnecting the piping or putting solid plates to block off the piping from the confined

space. If valves are used to isolate the piping, a special double-block system must be used so that nothing can leak into the confined space. Under special circumstances, a professional engineer can certify that a valve isolation system is safe for a worker to carry out intended work in a confined space.

See Guideline 9.18(3)(b) for more information.

### **Poor visibility**

Poor visibility increases the risk of accidents and makes it harder for a standby person to see a worker who may be in distress. If poor visibility results from inadequate lighting, the light levels should be increased (although area lighting is not always required). If activities such as sandblasting or welding result in poor visibility, appropriate ventilation may be needed to reduce harmful substances in the air.

If portable lighting is used where there may be an explosive atmosphere, the lighting must be “explosion-proof.” (The Canadian Electrical Code has a description of lighting that is approved for use in explosive atmospheres.)

Emergency lighting such as flashlights or battery-operated area units must be provided where necessary, so that workers can locate exits and escape.

### **Temperature extremes**

Special precautions are needed before workers enter equipment such as boilers, reaction vessels, and low-temperature systems. A qualified person must provide these procedures. Allow enough time for cooling of confined spaces that have been steam-cleaned.

A worker should not be exposed to temperature extremes that could cause their core temperature to exceed 38°C or fall below 36°C. The effect of “wind chill” must also be considered.

### **Noise**

Noise produced in confined spaces can be particularly harmful because of reflection off walls. Noise levels from a source inside a small confined space can be up to 10 times greater than the same source placed outdoors. If the noise levels cannot be reduced, proper hearing protection must be worn where necessary.

An employer must ensure that a worker is not exposed to noise levels above either of the following exposure limits:

(a) 85 dBA Lex daily noise exposure level;

(b) 140 dBC peak sound level.

### **Risk of drowning**

Confined spaces should be fully drained or dry when entered. Spaces that are not fully drained or dry may pose a risk of drowning. The risk of drowning in a vat or tank with a large amount of liquid is easily recognized. However, workers have drowned in small pools of liquid. For example, insufficient oxygen, the presence of a toxic gas, or a blow to the head can make workers unconscious. Workers who have fallen face-down into a small pool of water have drowned.

### **Work Related Hazards**

In one-third of accidents involving harmful gases or lack of oxygen, the danger was not present in the confined space when the worker first entered it. Rather, the work in the confined space created the hazardous atmosphere.

Exposure deadens the sense of smell, which means you could be walking TOWARD rather than AWAY from the source and not know it.

NOTE: Combining chemicals may result in a toxic gas being released. Always read the SDS to get the information you need about mixing two products.

Some confined spaces become unsafe as a result of the conditions or work that is done inside them. Examples of conditions that can make a confined space unsafe are:

- a) manholes in contaminated ground e.g. near a leaking underground gasoline storage tank, into which poisonous or flammable gases can seep;
- b) manholes, pits or trenches connected to sewers, in which there can be a build-up of flammable and/or poisonous gases and/or insufficient oxygen in the air;
- c) tanks or pits containing sludge's and other residues which, if disturbed, may partially fill the confined space with dangerous gases; and
- d) confined spaces that contain rotting vegetation, rusting metal work, and similar natural oxidation processes that create an oxygen-deficient atmosphere.

Some examples of confined spaces in which changing conditions or activities in progress can make the space unsafe are:

- a) some painting work and the application of certain adhesives, cleaners and liquids such as paint thinners. These can produce dangerous amounts of solvent vapour, which can cause dizziness and impair judgment. Such solvents are often flammable so there is an accompanying risk of fire;
- b) welding activities may generate toxic gases or vapours and,
- c) the use of gasoline or diesel engines can lead to the build-up of poisonous carbon monoxide gas. There is also a risk of fire resulting from leaks and,
- d) introduction of hot work.

In some cases, a confined space can become unsafe because of the inherent characteristics of activities that occur outside the space. Examples include:

- the filling/emptying of an adjacent compartment/tank;
- weather changes, such as thunderstorms i.e. a drop in barometric pressure, lightning, etc.;
- heat of the day increasing vapourization and affecting personnel i.e. heat exhaustion and,
- pipelines entering the confined space may contain hazardous materials.

Normally, mechanical ventilation is set up to bring outside air into the confined space.

If the intake hose is located beside a running vehicle or equipment with an internal combustion engine, the intake hose brings in exhaust fumes.

### **Human Factor Hazards**

Some workers may have phobias (e.g. claustrophobia, fear of heights) that could interfere with their ability to work in a confined space. The use of bulky personal protective equipment (especially respirators) can also cause heat stress and fatigue.

The physical condition of workers may also be a factor in cases where there are temperature extremes, or the work is physically demanding. As a result, some workers may not be suited for work in confined spaces. The employer should consider the physical condition of the workers during the hazard assessment process. Fitness-to-work assessments should be done by a qualified professional to ensure it is safe for workers to perform work in a confined space.

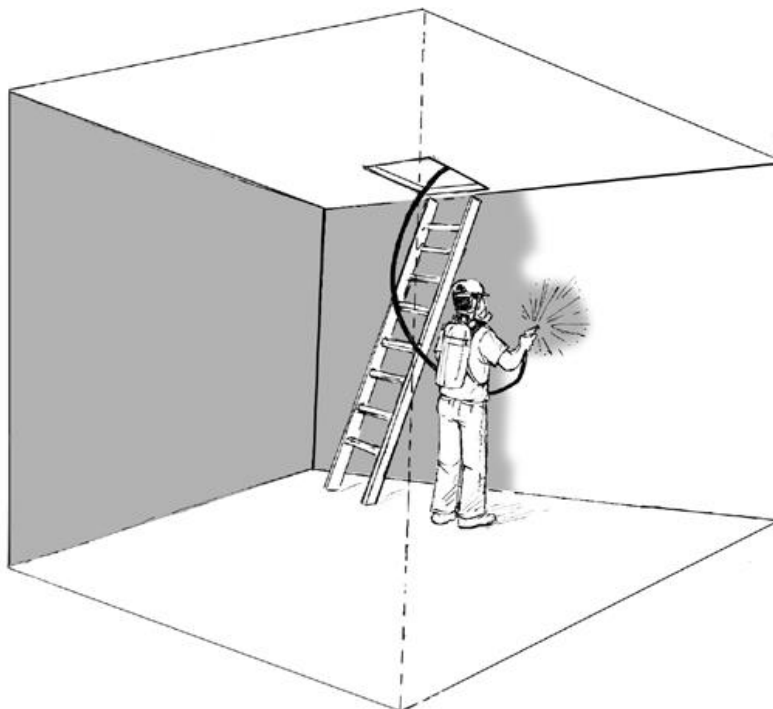

*Related Guidelines:*

### **Other hazards to be controlled**

*A determination must also be made whether or not the space may contain or may have contained a harmful substance (as defined in section 9.1 of the Regulation) before any workers enter the space. For example, a crawlspace that contains asbestos pipe insulation might be excluded using the criteria in the table above; however, workers would still have to wear appropriate personal protective equipment while working in the space.*

*Although an enclosed space might not be considered a "confined space," it may have other hazards that must be controlled. The other parts of the Regulation still apply and must be considered when planning entry and work in these spaces. Other relevant provisions that the employer needs to consider include the following:*

- *Lockout (Part 10)*
- *Working Alone (Part 4)*
- *Occupational First Aid (Part 3)*
- *Personal Protective Clothing and Equipment (Part 8)*
- *Diving Operations (Part 24)*

### **Determination regarding other spaces**

*WorkSafeBC may determine other types of spaces to be excluded from the application of Part 9 of the Regulation which do not meet the exclusion criteria or include spaces where an employer proposes to perform work that will generate air contaminants. Such determinations will be made based on an evaluation by a committee of WorkSafeBC personnel with expertise in confined spaces.*

*Persons interested in having WorkSafeBC assess whether a certain type of space should be determined not to be a confined space for the purposes of Part 9 of the Regulation may contact the Prevention Practices and Quality Department or the WorkSafeBC office in their region.*

### **Regulatory excerpts**

*Section 9.1 of the OHS Regulation ("Regulation") states:*

**"confined space"**, except as otherwise determined by the Board, means an area, other than an underground working, that

(a) is enclosed or partially enclosed,

(b) is not designed or intended for continuous human occupancy,



*(c) has limited or restricted means for entry or exit that may complicate the provision of first aid, evacuation, rescue or other emergency response service, and*

*(d) is large enough and so configured that a worker could enter to perform assigned work;*

**"high hazard atmosphere"** means an atmosphere that may expose a worker to risk of death, incapacitation, injury, acute illness or otherwise impair the ability of the worker to escape unaided from a confined space, in the event of a failure of the ventilation system or respirator.

**"low hazard atmosphere"** means an atmosphere which is shown by pre-entry testing or otherwise known to contain clean respirable air immediately prior to entry to a confined space and which is not likely to change during the work activity, as determined by a qualified person after consideration of the design, construction and use of the confined space, the work activities to be performed, and all engineering controls required by this Regulation;

*This guideline provides information to further explain some of the terms that appear in 9.1 (Definitions) of the Regulation. Matters discussed include:*

- *Underground workings*
- *Not designed or intended for continuous human occupancy*
- *Restricted means for entry or exit*
- *Entering the space*
- *High hazard atmosphere*
- *Low hazard atmosphere*

### **1. Underground working**

*The definition for "confined space" in section 9.1 of the Regulation excludes underground workings. An underground working is defined in section 22.1 of the Regulation, as including "any adit, tunnel, underground excavation, chamber, caisson, raise, shaft, winze or natural entry." The exclusion applies while the underground area is under construction. Once construction is complete, the underground area will be a confined space if it meets the criteria listed in paragraphs (a) to (d) of the definition for confined space in section 9.1.*

### **2. Not designed or intended for continuous human occupancy**

*According to the definition of a confined space in section 9.1 of the Regulation, if an enclosed or partially enclosed space is designed or intended for continuous human occupancy, then it is not a confined space. When identifying confined spaces for the*

*purposes of Part 9, an employer needs to include the following principles in determining whether each space is designed or intended for continuous human occupancy.*

*If a space is designed or intended for continuous human occupancy, it will generally:*

- *Incorporate a permanent Heating, Ventilation and Air Conditioning (HVAC) or similar system*
- *Rely in its design on relevant codes as applicable, including the BC Building Code, National Fire Code, BC Electrical Code, BC Plumbing Code, Mechanical Refrigeration Code, and municipal by-law requirements*
- *Include installed utility services that anticipate human occupancy e.g., hard-wired lighting rather than portable lamps, plumbed water lines rather than hoses etc.*
- *Not be designed as a container or conveyance of a product or substance*
- *Be entered for purposes other than periodic inspection, maintenance, repair or construction*
- *Include designed access and egress means such as doorways and staircases*
- *Incorporate features intended solely to accommodate continuous occupancy e.g., have amenities associated with continuous occupancy such as furniture, flooring material, wall coverings*
- *Be designed to allow worker self-rescue if there is a failure of the above features.*

*A space needn't have all the features described above in order to be designed or intended for continuous human occupancy. The more of these characteristics that are included in the design and use, the more likely the space will be considered to be designed and intended for continuous human occupancy and therefore not fall within the definition of a confined space.*

### **3. Restricted means for entry or exit**

*To be considered a confined space, a work area must meet all four criteria in the definition. A criterion that often raises questions is paragraph (c), which addresses limited or restricted means of entry or exit that may complicate the provision of emergency response.*

*Entry or exit refers to crossing the portal between the confined space and the outside work area, but also includes consideration of the routes inside the confined space for gaining access to the work area in the space or returning to the portal from it.*

*Criterion (c) lists four types of emergency responses.*

- *First aid, which refers to treatment for the purpose of preserving life and minimizing the consequences of injury until medical treatment is obtained, and treatment of minor injuries.*

- *Rescue, which involves removing a worker or workers from danger, in circumstances where they have become incapable of removing themselves.*
- *Evacuation, which refers to the exit of the entire workforce from the work area in an emergency situation.*
- *Other emergency response, which includes scenarios such as firefighting, and hazardous materials spill response.*

*The issue in paragraph (c) is whether the means of entry or exit "may complicate" the provision of one or more of the four types of emergency response. Some factors to consider for different types of emergency situations are provided below.*

***First aid and rescue:*** *First aid and rescue are often closely related in practice. First aid includes both injury treatment and preparation of an injured worker for transport on a device such as a spine board, stretcher, sked, or ked. Rescue may involve some initial injury treatment at the site of injury and will always involve removal of a worker from danger, for example, by use of a transport device, or other means such as a lifeline and harness. When carrying a worker on a transport device the normal practice for the response team is to carry it at about hip level with the arms of the bearers extended downward.*

*The following are some examples of situations where the means of entry or exit will typically be considered to have complicated the provision of first aid or rescue:*

- *A space for which the means of exit prevents the use of a first aid transport device and requires a worker to be removed from the space by other means such as a harness, lifeline, and possibly a lifting device.*
- *A space in which circumstances impede the ability to transport an injured worker. For example:*
  - *The exit port of the space is narrower than the width of the transport device.*
  - *The exit port is so constructed that a person carrying the device has no alternative but to put it down in order to get through the port or pass it to another person through the port.*
  - *The transport device needs to be lifted at any time to shoulder height or higher when exiting the space with the injured worker in it. (Such lifting might be needed, for example to get a stretcher over top of a piece of machinery on the way to the exit port, or if the exit port was well above floor level and access on a stairway or ramp was not possible.)*
  - *The transport device needs to be inclined at any time to an angle of 45 degrees or more above horizontal. (This might occur, for example, when easing the device up to the exit port and out of the space.)*
  - *Specialized equipment such as a block and tackle or other equipment is necessary during the exit scenario to lift or direct the transport device.*
- *A space with a potentially dangerous atmosphere and a means of entry or exit that is so constructed that first aid or rescue workers wearing self-contained*

*breathing apparatus (SCBA) must remove tanks from their backs at any point when entering or exiting.*

**Evacuation:** *Whether or not the means of exit may complicate the evacuation of workers from a space will typically depend on factors such as the potential speed of onset of danger, the number of workers in the space, and the obstacles they may encounter when exiting.*

*If there is the potential for rapid onset of danger, for example, from release of a flammable or toxic atmosphere into the space, it is essential that exits are sufficiently accessible so that workers can exit the space without any delay, regardless of the number of workers. If the impediments to evacuation would result in any delay, then the means of exit will be considered to have complicated the capability to evacuate the space.*

*On the other hand, a space may be one in which the onset of danger would be slow, for example, where the danger could arise from water flowing through a small diameter pipe into a large space, at such a low rate that any danger to workers would only occur after a considerable period of time. In such cases, it may be safe for workers to evacuate the space over a longer period, as long as the evacuation was done in a timely manner, and the time needed did not compromise the safety of any worker.*

**Other emergency response services:** *Depending on the space, other emergency response scenarios could include services such as fire fighting or controlling hazardous material spills. If emergency response workers in these situations would need to wear an SCBA or other personal protective gear, and the means of entry or exit is so constructed that any of the gear must be removed when entering or exiting, then the provision of the emergency response will have been complicated by the means of entry and exit.*

#### **4. Entering the space**

*Paragraph (d) of the definition for confined space in section 9.1 requires that the area in question be "large enough and so configured that a worker could enter to perform assigned work." A worker should be considered to have entered a confined space when the breathing zone of the worker crosses the plane of the confined space access.*

#### **5. High hazard atmosphere**

*The exposure limits in the Table of Exposure Limits for Chemical and Biological Substances (refer to OHS Guideline G5.48-1) are not used to define the boundary between a moderate and high hazard atmosphere confined space. Section 1.1 of the Regulation defines IDLH atmosphere as "an atmosphere containing a substance at a concentration which is immediately dangerous to life or health (IDLH) because the concentration is greater than that from which one could escape without any escape-*

*impairing symptoms or irreversible health effects, and includes an atmosphere with an unknown concentration with the potential to be immediately dangerous to life or health."*

*IDLH levels for specific contaminants are available from sources such as Documentation for IDLH Concentrations, NIOSH May 1994, or may be specified on the SDS for the substance. An atmosphere meeting this definition would be high hazard under section 9.1. However, the definition of high hazard also covers other situations. In determining whether a confined space contains a high hazard atmosphere, consideration should be given to:*

- *The space's original atmospheric conditions*
- *The contaminants that will be generated by the work to be done in the space*
- *The ventilation or other engineering controls applied to remove or reduce the level of contaminants*
- *The rate at which the atmosphere will deteriorate on failure of the engineering controls*
- *The ability to recognize failure of engineering controls*
- *The time required for a worker to leave the space unaided*

*The atmosphere will generally be classified according to the level of contaminants after the application of engineering controls. However, if on failure of the controls, the level of contaminants may increase at a rate that will prevent the worker from escaping unaided, the atmosphere is high hazard.*

## **6. Low-hazard atmosphere**

*The definition of low hazard atmosphere includes a reference to a qualified person. Qualified is generally defined in section 1.1 of the Regulation. However, the determination whether an atmosphere is low hazard is part of the hazard assessment required to be done by a qualified person under sections 9.9 and 9.11. Section 9.11 sets out specific requirements for who is a qualified person for this purpose. Refer also to OHS Guideline G9.11.*

*The definition also refers to "an atmosphere which is shown by pre-entry testing or otherwise known to contain clean respirable air...." Paragraph 9.25(7)(c) states "Pre-entry atmospheric testing is not required in a confined space with a low hazard atmosphere if...prior representative sampling has demonstrated that the atmosphere within the space or group of similar spaces meets the low hazard atmosphere definition." Refer also to OHS Guideline G9.25. This sampling will commonly be the basis for it being "otherwise known" that a space contains clean respirable air.*

## 9.10 Procedures

This section covers the information required on written safe work procedures that must be included in the confined space entry program and who is qualified to prepare them.

### **Legislation states,**

Written procedures specifying the means to eliminate or minimize all hazards likely to prevail must be developed, based on the hazard assessment required by section 9.9.

### Reference:

The qualified person must write procedures specific to each confined space entry based on the hazard assessment. The hazard assessment takes into account the conditions of the space prior to entry as well as the work activities that will take place inside the space. The written procedures therefore will also consider both. Workers must be trained in the precautions identified in the written procedures.

The written procedure must explain the means to eliminate or minimize the risk of all hazards identified. For instance, a written procedure for a specific confined space will explain, where required:

- What to include in the entry permit
- Lockout and isolation
- Verification of all precautions and testing the atmosphere, including how to set up specific air-monitoring device(s) for the identified hazards (such as oxygen deficiency and the contaminants present), where the monitoring is to occur, and how frequently
- Cleaning, purging, venting, or inerting
- Ventilation required, including proper placement of the ventilating system
- The standby person's duties, including numbers to call for help
- Rescue personnel and procedures
- Lifelines, harnesses, and lifting equipment
- Personal protective equipment (for example, fall protection, safety headgear, or respirators)
- Other precautions required by the Occupational Health and Safety Regulation such as keeping hazardous compressed gas tanks outside the space, ensuring hoses do not block the entranceway, ensuring electrical tools and equipment are grounded or double-insulated, protected by a ground fault circuit interrupter, and a CSA-approved for hazardous locations such as use in spaces that have flammable or explosive gas, ensuring ladders, scaffolds, work platforms meet the requirements of WorkSafeBC, and control measures required when there is reduced visibility

- Coordination of work activities (for instance, ensuring that contractors are well informed of procedures and ensuring specific tasks will not harm other workers)
- Equipment required for entry and instructions for use (for example, the ladder size, tie-off point, and tool bucket for lowering tools to workers inside the space)

## ***Testing the atmosphere***

Before a worker enters a confined space, the atmosphere must be tested in accordance with the written procedures developed by the qualified person.

This section refers to the information on:

- Testing initial conditions
- Continuous monitoring
- Proper test procedures and equipment
- What to test for (oxygen, explosive conditions, and contaminants)
- When and where to test



### **Testing initial conditions**

Confined spaces may contain explosive, toxic, or oxygen-deficient atmospheres. Whenever possible, test the atmosphere with a gas detector before opening hatches or starting ventilation. This will help identify whether or not an explosive atmosphere exists or help prevent the venting of a hazardous atmosphere out of the space into areas occupied by workers. Where there is an explosive gas just under the surface of the cover, creating a spark could cause an explosion.

Even if it is not possible to test before opening the space, do pre-entry testing before any ventilation is applied to the space. This provides a record of:

- Hazards that normally exist in the space.
- The amount of ventilation required for the space.
- How hazardous the air inside the space is hazardous to workers.

Pre-entry testing is often conducted more than once, it should be done before the space is ventilated and not more than 20 minutes before a worker enters the space. The results must be recorded and posted at all points of entry to the confined space (whether or not a continuous monitor or single-test device is used). Refer to employer's confined space entry program for information on what to test for and when to test.

Testing must be conducted to verify that the required precautions have been effective at controlling the identified hazards and that the atmosphere is safe for a worker to enter a confined space. (Note that pre-entry inspection for physical hazards is also required)

## Continuous monitoring

A continuous monitor should be used whenever practicable to ensure the safety of workers. The monitor will typically provide continuous readings of the oxygen level and level of any explosive gases or vapours, if present. In addition, many monitors have the capability of being configured to test for other harmful gases that may be present, such as carbon monoxide (CO) or hydrogen sulphide (H<sub>2</sub>S). The monitor provides an alarm if any of these go beyond preset limits. The qualified person will investigate the reason for the alarm before workers re-enter. Some contaminants cannot be monitored using a continuous monitor. The concentration of these contaminants must be monitored using other devices described in the written work procedure provided by the qualified person.

A properly calibrated and maintained continuous monitor will register any change in the atmosphere and an alarm will sound at preset limits. If a wide enough margin of safety is applied to the alarm settings, the alarm can be used to indicate that workers must leave the space. Alarm level settings should be determined by a qualified and competent person.

The employer must use a continuous monitor if an atmosphere in excess of 20% of the lower explosive limit (LEL) could develop. Note that some sources use lower flammability level (LFL) instead of LEL; the terms are interchangeable.

The qualified person will ensure appropriate monitoring equipment is used for contaminants whose concentrations could exceed the protection provided by respirators.

## Proper test procedures and equipment

Testing must be conducted in accordance with written procedures and the following requirements:

- Each confined space atmosphere test must be carried out by an adequately trained worker.
- Use reliable equipment that has been properly serviced, calibrated, bump tested, and maintained according to the manufacturer's instructions.
- Keep a testing record that shows the:
  - Date and time of the test
  - Tester's initials
  - Concentrations of vapours, gases, or other conditions
- Test results should be posted without delay at all points of entry to the confined space.





The monitor should be tested first in clean outside air. If the reading is above or below 20.9% oxygen, there may be a problem with the oxygen sensor or with the calibration of the unit. Do not use this monitor for testing inside the confined space, and do not enter the confined space until a properly calibrated monitor is used. In conditions of high humidity, refer to the manufacturer's instructions.

### **Qualifications of Testers**

A trained worker, as identified in the written work procedures, may test the atmosphere in the confined space. Training should include:

- Reliability and limitations of the testing equipment.
- Requirement to use calibrated testing equipment.
- The manufacturer's instructions for use and maintenance.
- Sampling techniques and methods to test the atmosphere (for example, use of a pump device and a probe to determine the concentration of contaminants from outside the space, and ensuring enough testing time for a continuous monitor to register an accurate reading).
- Allowable limits of exposure for each contaminant.
- How to use the monitor to obtain and interpret readings from a continuous monitor (for example, when to take peak readings).
- Substance-specific monitoring equipment, when used.

### **Selection of Monitoring Equipment**

Recommended features include:

- Accurate, reliable, and specific readouts.
- Immediate readout capability.
- Remote sensors or extension tubes to minimize the need for the tester to enter the confined space.
- Continuous monitoring capability, with an alarm for use in spaces where a hazardous atmosphere could develop after entry.
- Continuous monitor with data-logging capability to record conditions in the space.
- Capability of obtaining peak readings.



### **Calibration of Equipment**

The employer must ensure that the testing required by subsection (1) is performed using calibrated test instruments appropriate for the atmosphere being tested and the instruments are used in accordance with the manufacturer's specifications.

Calibration refers to setting the test instrument to a standard to make sure it is reading accurately through a range of concentrations. Calibration is done by comparing the instrument's reading to a range of known concentrations and adjusting the monitor to read accurately.

The manufacturer's instructions specify the calibration requirements, including calibration frequency and "bump" tests. A bump test uses a known concentration to verify that the instrument is responding correctly to a known concentration. Monitoring equipment must be calibrated according to the frequency specified in the manufacturer's instructions and must be bump tested or spanned as required prior to use. For example, manufacturers may require calibration every 30 days and bump testing daily at the start of the shift.

### What to Test For

Before entry into a confined space, test for the following:

1. **Oxygen level** (measured as a *percentage* of oxygen in the air)
2. **Explosive conditions and flammable gases** (measured as a percentage of the LEL or as mg/m<sup>3</sup>)
3. **Contaminants that have been identified in the hazard assessment** (measured as the concentration in *parts per million, or ppm* or as mg/m<sup>3</sup>)



### Oxygen level

The amount of oxygen in the air is usually tested first since oxygen deficiency can cause serious injury or death. In addition, a low percentage of oxygen may affect the flammability reading on the monitor. Be aware that many oxygen meters are affected by high relative humidity. When checking for oxygen in moist atmospheres, keep the probe pointed downward and wipe water droplets from the probe when they develop.

Clean outside air contains about 20.9% oxygen. The hazard assessment should state if the confined space is expected to contain less than 20.9%. If the oxygen reading is less than 20.9% and this was expected, then proceed using the required control measures stated in the written work procedures. If the oxygen reading is less than 20.9% and this decrease in oxygen was not expected, the reason must be investigated by the qualified person to ensure the space is safe to enter. It is vitally important to understand what is causing the change in oxygen level. The reason must be identified before workers are allowed to enter the space. For example, many toxic gases present a high hazard to

workers even when the concentration is low enough to cause only a very small displacement of oxygen.

Entry by workers into a confined space containing less than 19.5% oxygen may be life-threatening. Every effort must be made to bring the level of oxygen above 19.5%. Procedures to do this will be in the written work procedures provided by the qualified person. In certain situations, the work procedures may include use of a self-contained breathing apparatus (SCBA) or a supplied-air respirator with escape bottle.

### **Explosive conditions and flammable gases**

Explosions or fires can result from gases, vapours, and dusts in a confined space. Test for flammable gases such as methane hydrogen, ethane, and propane. Be aware that flammability tests do not measure the concentration of toxic contaminants. Gases or vapours that are both toxic and flammable must be measured with a monitor capable of measuring both the concentration and the flammability.

It is also important to measure the concentration of dusts such as coal and grain dusts, which may explode when a certain level of dust in the air is reached. The qualified person should be consulted to ensure the correct measuring device is used.

Workers must not be allowed to enter a confined space under any circumstances when the flammability is greater than 20% of the LEL. It is good practice to prohibit hot work in atmospheres providing a reading on the flammable gas meter above 1%.

### **Air contaminants**

Measure all potential air contaminants identified in the hazard assessment. This includes measuring contaminants already in the space, those that are brought into the space, and those that are generated in the space during work activities. Here are some examples of measurements that may be required:

- Carbon monoxide, if there is any combustion of fuel – for example, in welding, generators, or equipment that is run by internal combustion engines – either inside or adjacent to the confined space.
- Styrene, if there is fibreglassing.
- Sensitizers, when using any products such as epoxies, urethanes, or isocyanate-containing paints or coatings.
- Vapours of the toxic component in cleaning products being used in the space.
- Dusts – particularly allergenic dusts, wood dust, and grain dust – for contaminant levels and the potential for explosion.
- Hydrogen sulfide, where there are any connections to a sewer or sour gas line or where any material will be rotting inside or adjacent to the space.
- Benzene or other hydrocarbons in contaminated soil.

- Other contaminants that could be found inside the space or may be brought into the space through the ventilations system.

The qualified person will know what tests are required and the allowable limits for these contaminants.

Many testing devices test several gases and vapours simultaneously. If the sensors on the monitor do not test for *all* the contaminants identified in the hazard assessment, use additional monitoring equipment appropriate for the contaminants and conditions.

Workers must not be required to wear respirators to reduce their exposure if clean respirable air can be supplied to the confined space. Respiratory equipment is to be considered a second choice for exposure control. The first choice must be changing the air inside the space to breathable air. In some cases, it may be impractical to use ventilation, or the nature of the contaminants inside the space may require both ventilation and respirators. The work procedures written by the qualified person will outline what is required. Properly trained and protected workers may need to enter a poorly ventilated confined space for rescue purposes.

## **When to Test**

Test the atmosphere:

- Before opening access to the space, if possible.
- Immediately after the space has been opened.
- At hazard points during line disconnect or other isolation procedures.
- Immediately before initial entry into the confined space (within 20 minutes of entry).
- Before workers re-enter a space after it has been vacated for more than 20 minutes.
- While workers are inside the space, at close enough intervals to ensure the continuing safety of workers.
- 
- Before and after procedures such as cleaning and purging.
- When there is a change in work.
- During work that causes contaminants to be generated in the work space.
- If a change of atmosphere is suspected or it is possible that control measures cannot or do not ensure a safe atmosphere.
- If a hazardous substance is accidentally released into the confined space.
- If a worker indicates symptoms of exposure to air contaminants, for example a “light-headed” feeling, headache, a choking or coughing feeling, nausea, burning or fogging eyes.
- If ventilation fans have been shut down for any reason.

## Where to test

Test in the following places:

- Around the opening while making a first approach to the confined space.
- At locations where transfer pipes lead to the confined space.
- Around irregular features such as baffles, bulkheads, and sumps in the confined space.
- At locations where workers perform work.
- At all elevations inside the confined space, and in those areas where gases and vapours are likely to accumulate.

### Immediately dangerous to life or health (IDLH)

Some situations are considered immediately dangerous to life or health. IDLH atmospheres contain hazardous substances at a concentration that places the worker in immediate danger because they either:

- Impair the workers ability to leave the area (“self-rescue”) or
- Lead to irreversible health effects, serious injury, or death in minutes

Some gases and vapours will have an immediate effect on the body. Workers exposed to a high enough concentration of a contaminant will experience nausea, vomiting, dizziness, and a loss of concentration. Workers who experiences these symptoms are likely being exposed to the IDLH concentration, meaning the worker’s life is in danger and escape may be impossible. Some substances have very low IDLH concentrations – for example, the IDLH level for hydrogen sulphide is only 100 ppm. Allowable exposure limits are generally well below the IDLH concentration.

Other conditions considered IDLH include and oxygen- deficient atmosphere and atmospheres with contaminants at or above 20% of LEL. Any untested confined space is considered IDLH.

## 9.11 Qualifications

Legislation states,

(1) The hazard assessment and written confined space entry procedures must be prepared

(a) by a qualified person who has adequate training and experience in the recognition, evaluation and control of confined space hazards, and

(b) in consultation with the person assigned overall responsibility for administration of the confined space entry program and with the joint committee or the worker health and safety representative, as applicable.

(2) For the purposes of subsection (1)(a) qualifications which are acceptable as evidence of adequate training and experience include

(a) certified industrial hygienist (CIH), registered occupational hygienist (ROH), certified safety professional (CSP), Canadian registered safety professional (CRSP) or professional engineer (P. Eng.), provided that the holders of these qualifications have experience in the recognition, evaluation and control of confined space hazards, or

(b) Repealed.

(c) other combination of education, training and experience acceptable to the Board.

Section 9.11(1) of the *OHS Regulation ("Regulation")* requires a hazard assessment and written confined space entry procedures be prepared by a "qualified person who has adequate training and experience in the recognition, evaluation and control of confined space hazards".

Section 9.11(2) of the *Regulation* states "For the purposes of subsection (1)(a) qualifications which are acceptable as evidence of adequate training and experience include:

(a) certified industrial hygienist (CIH) or registered occupational hygienist (ROH) with experience in confined space entry,

(b) Repealed

(c) other combination of education, training and experience acceptable to the Board."

*Related Guidelines:*

*The purpose of this guideline is to provide direction to employers on how to meet their obligations to select qualified persons to create confined space hazard assessments and work procedures. It also provides contact information on some of the accrediting agencies that issue professional certifications referenced in section 9.11.*

### ***Employer due diligence***

*Employers are responsible for selecting qualified persons, as defined in section 9.11 of the Regulation, to undertake confined space hazard assessments and written entry*

*procedures. The employer must exercise due diligence in the selection of the qualified person. This is especially necessary if the person being engaged does not hold one of the certifications or the license credentials specified in section 9.11(2) (a) or (b). While each case must be considered on its merits, reliance by an employer on a person holding a certification or license specified in section 9.11(2) as being a "qualified person" for the purposes of section 9.11 would normally be considered reasonable, however, due diligence in all cases includes a review of the person's experience as well as their accredited credentials.*

*Section 9.11(2)(c) permits persons not certified or licensed to be considered qualified for the purposes of this section. Anyone experienced, knowledgeable and capable of doing the required hazard assessments and writing appropriate safe work procedures may be considered to be a "qualified person." The education, training and experience required to complete a particular confined space entry assessment and to write appropriate procedures will depend on the complexity of each situation and the hazards to be controlled.*

*Factors employers should evaluate in determining whether a person selected to undertake the confined space hazard assessment and entry procedures under 9.11(2)(c) is qualified include:*

- *Specific education and training the person has received, and relevance to the industry or type of space the person will encounter*
- *Extent of experience with confined space entry relevant to the industry and type of space the person will encounter*
- *Experience with specific elements or tasks related to confined space entry, such as:*
  - *lockout and isolation*
  - *air monitoring*
  - *ventilation*
  - *use of lifeline, harness and lifting equipment*
  - *the use of personal protective equipment*
  - *participation in rescue drills*
  - *previous assessments conducted and procedures written.*
- *Proficiency with applying exposure limits*

*A deficient confined space risk assessment or work procedure may be an indication the person selected was not qualified to do the hazard assessment and/or develop the written confined space entry procedures. In all such situations, whether the person selected purports to be a qualified person under subsection (a), (b) or (c), prevention*

*officers will enquire what steps the employer took to assess the person's qualifications. It should be noted that when evaluating the qualifications of a person who has prepared a hazard assessment and confined space procedures, the officer's primary focus will be the quality of the assessments and procedures rather than the person's credentials.*

*Where prevention officers encounter hazard assessments and work procedures that are deficient and the person selected meets the definition of "qualified person" in s. 9.11 (2) (a) or (b), the employer who engaged the "qualified person" may file a complaint with the accrediting agency.*

*Note that in addition to engaging qualified persons, employers are also responsible for ensuring that the confined space hazard assessment contains the required elements, and that the written confined space entry procedures have been developed based on the hazard assessment (see s. 9.9(2) and s. 9.10).*

*Prevention officers will also assess the extent to which the employer knew or should have known that the assessment and/or procedures were deficient. In particular, prevention officers will enquire into what steps the employer took to ensure that ss. 9.9 and 9.10 were complied with.*



# Section 4: Identification and Entry Permits

This section covers the information on when an entry permit is required, what a permit contains, and when it can be altered.

## Learning Objectives:

1. Understand when an entry permit is required .
2. Identify the information that should be contained on an entry permit.
3. Understand by whom, and when an entry permit can be altered.

### **9.12 Identification**

#### **Legislation states,**

When a confined space requires entry by a worker, each point of access which is not secured against entry must be identified by a sign or other effective means which indicates the hazard and prohibits entry by unauthorized workers.

#### *Related Guidelines:*

*Refer to section 9.3 Prohibited entry*

### **9.13 When permits required**

#### **Legislation states,**

(1) An entry permit must be completed and signed by the responsible supervisor before a worker enters a confined space

- (a) with a high hazard atmosphere,
- (b) that requires lockout or isolation procedures to be followed, or
- (c) in which there is a hazard of entrapment or engulfment.



(2) An entry permit must be posted at each designated point of entry to a confined space.

(3) Subsection (2) does not apply if

(a) the entry permit is posted at a minimum of one designated point of entry,

(b) the identification at other designated points of entry includes up-to-date information on whether it is safe to enter, and

(c) all workers authorized to enter are informed of the location of posted entry permits.

#### Reference:

The purpose of an entry permit is to formalize entry into a confined space and to name the supervisor of the entry. A permit also informs workers of the hazards and entry procedures and keeps a record of workers who have entered. The permit must be posted at the entrance to the confined space, verifying that a review of the requirements has been conducted.

Depending on the sophistication of the confined space entry program, information on specific work procedures may be stored in a database designed to automatically insert the information into an entry permit for the specific confined space.

A sample entry permit is shown in the appendices.

### **9.14 Contents of permit**

#### **Legislation states,**

An entry permit must identify the

(a) confined space and the work activities to which it applies,

(b) workers who are inside the space,

(c) required precautions for the space, and

(d) time of expiration of the permit.

#### *Related Guidelines:*

*Paragraph 9.14(d) of the OHS Regulation states that an entry permit must identify "the time of expiration of the permit".*

*An entry permit will cover a specific task or project, which may occur over a number of shifts. The time of expiration of the permit is based on the estimated time to complete the project's work activities and will be identified on the permit. An entry permit should be treated as expired sooner than the stated time of expiration if one of the following occurs:*

- *the confined space is placed back in service,*
- *continuity in responsible supervision for the confined space is broken, or*
- *the task or project is interrupted for a significant time because of an emergency that affects the confined space, such as an accident, rescue requirement, or a breakdown of engineering control equipment.*

*Once an entry permit has expired, a new permit must be issued before entry into the confined space is allowed.*

#### Reference:

Some employers use the permit as a means of displaying and/or recording additional information, such as:

- Air monitoring results, including the tester's initials
- Lockout procedures
- The ventilation required and the air flow required
- The required air-testing equipment and contaminants that must be monitored.

### **9.15 Updating the information**

#### **Legislation states,**

(1) Once issued, the information on an entry permit may only be altered by

(a) the responsible supervisor who signed the permit to update it in accordance with subsection (2) or (3),

(b) the standby worker to update the list of workers inside the confined space, or

(c) the tester to record test results.

(2) An entry permit must be reviewed and updated as necessary to ensure the ongoing safety of the workers inside the space.

(3) The permit must be re-authorized and signed by the responsible supervisor

(a) if there is a change in the work crew,

(b) after each shift change, or

(c) after a change of the responsible supervisor.

(4) Every worker affected must be informed of an alteration of an entry permit regarding a change in the required precautions or work activity.

### ***9.16 Record of permit***

**Legislation states,**

A copy of the signed entry permit must be kept for at least one year.

# Section 5: Lockout and Control of Harmful Substances

This section defines the term and process Lockout; discusses the control of harmful substances in adjacent piping and, various isolation techniques for controlling harmful substances.

## Learning Objectives:

1. Understand the term Lockout.
2. Understand what a Lockout process is.
3. Understand the definition of Adjacent Piping.
4. Be familiar with how harmful substances in adjacent piping is controlled.
5. Understand the difference between the two general types of adjacent piping
6. Understand the three basic options for isolating adjacent piping.
7. Understand the difference between a blank and a blind.
8. Be familiar with a double block and bleed isolation system.

## **9.17 Lockout**

### **Legislation states,**

Before a worker enters a confined space, any material conveyance equipment that transports material to or from the space must be free of material if the material could present a hazard.

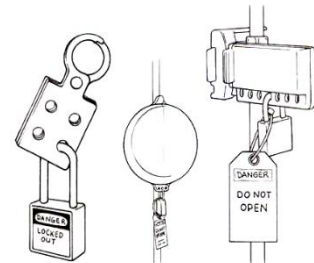

See Part 10, *De-energization and Lockout* of the OHS Regulation.

### Reference:

**Lockout** means the use of a lock or locks to render machinery or equipment inoperable or to isolate an energy source in accordance with a written procedure. Hazardous energy is any electrical, mechanical, hydraulic, pneumatic, chemical, thermal or other source of energy that could potentially injure a worker. For example, machinery or equipment with moving parts has mechanical energy, and steam in a pipe has thermal energy.

Locks are generally used to prevent the inadvertent startup or movement of machinery and equipment. Lockout is a two-step process. The first step is isolation. Isolation is a process used to stop the flow of energy or any other hazard. Some examples of this are disconnecting a line, setting a switch in the up or down position or closing a valve. The

second step is to affix a lock to the isolating device in order to prevent others from removing or changing the isolation. Affixing a personal lock is a very important step to ensure that the device controlling the energy or other hazard remains in its set state or position.

The consequences of not properly controlling hazards inside a confined space are often more severe than the failure to control a hazard in a non-confined space situation. It is for this reason that a confined space generally requires isolation that is more effective than normal lockout. For instance, the closing of a valve (with a lock if necessary) is generally adequate to lockout a hydraulic pump but is not adequate to control the flow of fluid into a space.

The employer's lockout program will outline the procedures required to make each confined space in the workplace safe to enter. The supervisor of the entry must ensure that all lockout precautions are in place before a worker enters a confined space. An entry permit is required for all spaces that require lockout.

### ***9.18 Control of harmful substance in adjacent piping***

#### **Legislation states,**

(1) Before a worker enters a confined space where adjacent piping contains a harmful substance that is

(a) a liquid with sufficient volatility to produce a hazardous concentration of an air contaminant, or

(b) a gas or vapour,

the harmful substance in the adjacent piping must be controlled by either disconnecting the adjacent piping or isolating it using blanks or blinds that meet the requirements of section 9.20.

(2) Subject to subsection (3), before a worker enters a confined space where adjacent piping contains a harmful substance that is neither

(a) a liquid with sufficient volatility to produce a hazardous concentration of an air contaminant, nor

(b) a gas or vapour,

the harmful substance in the adjacent piping must be controlled by either disconnecting the adjacent piping or isolating it using blanks or blinds that meet the requirements of section 9.20 or using a double block and bleed system that meets the requirements of section 9.21.

(3) Before a worker enters a confined space where adjacent piping contains a substance that is harmful only because of the temperature, pressure or quantity of the substance, the harmful substance must be controlled

(a) by either disconnecting the adjacent piping or isolating it using blanks or blinds that meet the requirements of section 9.20 or using a double block and bleed system that meets the requirements of section 9.21,

(b) by isolating the adjacent piping in a manner that a professional engineer has certified will make the confined space safe for a worker to carry out the intended work, or

(c) if there is no head pressure in the adjacent piping, by de-energizing and locking out each pressure source for the adjacent piping and depressurizing the adjacent piping.

(4) Where a confined space is

(a) subject to the ingress of gases from a gravity-flow municipal or domestic sanitary sewer system or storm sewer system, and

(b) protected from the ingress of gases by a p-trap,

a worker may enter the confined space only if the atmosphere of the confined space has been tested immediately before entry and the test results confirm that the confined space contains clean respirable air.

(5) If a worker enters a confined space of the type referred to in subsection (4), the following must be undertaken:

(a) the operational integrity of the p-trap must be confirmed immediately on the entry of the worker;

(b) while the worker is inside the confined space, the atmosphere of the confined space must be continuously monitored and confirmed to contain clean respirable air.

*Related Guidelines:*

*Section 9.18 of the Regulation addresses the isolation of harmful substances that exist in adjacent piping. Isolation is intended to address hazards arising from fluids (typically liquids, vapours, and gases) and other flowable materials such as slurries, dust, and powders.*

*This guideline clarifies when section 9.18 applies and provides interpretive information for each of its subsections.*

## **Adjacent piping**

*The definition of adjacent piping in section 9.1 of the Regulation is*

*"adjacent piping" means a device such as a pipe, line, duct or conduit which is connected to a confined space or is so located as to allow a substance from within the device to enter the confined space;*

*Under this definition there are two general types of adjacent piping.*

- *Piping that is "connected to a confined space," which is piping that has openings in the space creating the possibility of emptying its contents into the confined space.*
- *Piping that is not physically connected to the confined space but may be located nearby in a manner that could allow a substance from the piping to enter the space. An example would be a bleed pipe that may dump contents onto a drain that leads to a pipe connected to the confined space.*

*Under the definition there are two types of circumstances where piping or conduit in or near a confined space is not adjacent piping.*

- *A piping system that passes through the confined space: Such piping would not be considered to be adjacent piping if it is designed and maintained so there are no openings or other locations in the piping where leakage may occur, and work on or around the piping will not cause leakage. In such cases, measures must be adopted under section 9.4 (Control of hazards) to ensure worker safety when working in proximity to the piping. If any work in the space may result in leakage, then the piping must be treated as adjacent piping, in which case the control measures under section 9.18 apply. Leakage could occur for example, during a repair to a piping connection or replacement of a valve stem gland.*
- *Orifices between spaces: In some configurations there are adjacent spaces with one or more orifices in a common wall between them. Section 9.18 is based on the use of control measures such as blanks, blinds, disconnects, and double block and bleed devices. A wall between two spaces is typically of a width and configuration that the use of such devices is not possible. As such, an orifice in a wall between a confined space and another space is not adjacent piping. Therefore, the blank, disconnect, double block and bleed, and blind requirements do not apply.*

*However, the employer must ensure that workers are protected against any hazards associated with orifices under other provisions such as section 9.4 (Control of hazards). The application of section 9.4 means that the potential for fluid discharge into the*



*confined space must be controlled so that the hazards to workers are eliminated or minimized.*

*Examples of controls might include a gate over the orifice designed to prevent any leakage and secured in place so that it could not be dislodged from the closed position. For fluids that do not pose a vapour or gas hazard it may be appropriate to use a device to control fluid level in one of the spaces so that it does not rise to and flow through an orifice into the confined space where workers are present.*

*In the remainder of this guideline the isolation measures permitted under the various provisions of section 9.18 are described. Section 9.18(1) provides for the most general circumstances for adjacent piping and the subsequent subsections provide for more specific circumstances.*

### **Application of section 9.18(1) - Basic isolation options**

*This provision specifies three basic options for isolating adjacent piping: disconnection, blanks, and blinds.*

1. *Disconnection: Disconnecting is defined in section 9.1 of the Regulation as follows:*

*"disconnecting" means physically disconnecting adjacent piping from a confined space to prevent its contents from entering the space in the event of discharge; For example, if a pipe is disconnected, either a length of the pipe at least 10 times its diameter should be removed or the open ends of the disconnected pipe should be moved out of line so that leaks will not bypass the disconnection and continue into the confined space. In any disconnect procedure the requirements of the Regulation related to the protection of workers from contents of the piping must be complied with.*

2. *Blanking and blinding: Blanks and blinds are defined in section 9.1 of the Regulation as follows:*

*"blank" means a solid plate installed through the cross-section of a pipe, usually at a flanged connection;*

*"blind" means a solid plate installed at the end of a pipe which has at that point been physically disconnected from a piping system;*

*"blanking or blinding" means the absolute closure of adjacent piping, by fastening across its bore a solid plate or cap that completely covers the bore and that is capable of withstanding the maximum pressure of the adjacent piping;*

*The goal of a blank or blind is to eliminate any possibility of fluid entering a confined space. Since a conventional blank bisects flanges, if any fluid leakage were to occur it would discharge directly into the atmosphere. Fluid leakage cannot be allowed to pressurize an enclosed area, resulting in the possible entry of leakage into the downstream portion of the pipe. Requirements for blanks and blinds are specified in section 9.20.*

***Application of section 9.18(2) - Harmful substances that are not volatile liquids, gases, or vapours***

*This provision applies to substances in adjacent piping that cannot result in worker exposure to a gas or a vapour in the confined space. For this circumstance, another isolation measure is permissible - a double block and bleed system. This provision involves closing valves in the piping by locking out a drain or vent valve in the open position in the line between two valves that are locked out in the closed position. Requirements for a double block and bleed system are specified in Regulation section 9.21.*

***Application of section 9.18(3) - Materials hazardous only because of pressure, temperature, or quantity***

*This provision applies to materials that are not toxic or corrosive, and are harmful only because of pressure, temperature, or quantity. Typically, this requirement applies to systems carrying water or steam. Three isolation options are outlined in the Regulation.*

- 1. Controls meeting the requirements of section 9.18(2): This alternative specifies the options of disconnecting, blanking, blinding, or a double block and bleed system.*
- 2. Isolation per engineering certification (section 9.18(3)(b)): This alternative enables an employer to have a professional engineer certify a means of isolation as making the confined space safe for a worker to carry out the intended work in the confined space. Refer to OHS Guideline G9.18(3)(b) for more details*
- 3. De-energizing and locking out the pressure source: This control option applies if there is no head pressure in the adjacent piping (i.e., from neither gravity nor pumps). With this option, it is acceptable to de-energize and lock out each pressure source and depressurize the adjacent piping.*

*For this option to apply, the layout of the adjacent piping has to be such that if all of the valves are opened with pumps locked out, fluid would not flow into the confined space. In such cases, locking out the pumps and depressurizing the line provides sufficient control.*

### **Prohibition on the use of valves**

*The use of one or more valves as a means of isolation is not permitted except in certain specified cases for substances that are not volatile liquids, gases, or vapours; or are harmful only because of pressure, temperature, or quantity. If a double block and bleed system is used, it must meet the requirements of section 9.21.*

*The Regulation permits the use of valves as a means of isolation in the following two circumstances:*

- *Where a double block and bleed system is permitted under sections 9.18(2) and 9.18(3)(a)*
- *Systems of isolation as permitted under section 9.18(3)(b). (refer to OHS Guideline G9.18(3)(b))*

### **Application of sections 9.18(4) and (5) - Gravity flow sewer systems**

*This provision could apply to an industrial or sewage system confined space facility that has a sink or other plumbed device that connects to a sewer system.*

*A p-trap may be used as a means of isolation if all the following conditions are met:*

1. *The confined space is being isolated from a municipal or domestic sanitary or storm sewer system.*
2. *The sewer system is gravity flow only at the point of isolation. (The p-trap option does not apply to locations in sewer systems that are pressurized by a pump.)*
3. *The atmosphere is tested immediately prior to entry and the test results show that the space contains clean respirable air. Clean respirable air is defined in Regulation section 9.1.*
4. *The operational integrity of the p-trap is confirmed immediately on the entry of the worker. This may be as simple as pouring water into the trap in some cases.*
5. *Clean respirable air is maintained (as shown by continuous monitoring) while the worker is inside the space.*

### **G9.18(3)(b) Certification of isolation by a professional engineer**

*Section 9.18(3)(b) of the OHS Regulation states:*

*(3) Before a worker enters a confined space where adjacent piping contains a substance that is harmful only because of the temperature, pressure or quantity of the substance, the harmful substance must be controlled...*

*(b) by isolating the adjacent piping in a manner that a professional engineer has certified will make the confined space safe for a worker to carry out the intended work, or...*

*This guideline provides general information on the application of section 9.18(3)(b) and specific information on two circumstances where an employer might choose for a professional engineer to certify that the adjacent piping is isolated in a manner that makes it safe for a worker to carry out the intended work inside the confined space.*

### **Application of section 9.18(3)(b)**

*This section applies to substances that are harmful only because of the temperature, pressure, or quantity of the substance (and are not classified as harmful by virtue of their toxic, irritant, corrosive, or other harmful properties). Section 9.18(3)(b) does not apply if the substance can create a hazard while at the same time providing poor warning of the hazard. The lack of warning that a potential hazard exists is an additional hazard. For instance, this section does not apply to nitrogen or inert gases.*

*Mainly this section will apply to water or steam. WorkSafeBC recognizes that, for these substances, there are circumstances where it is impracticable to isolate the substance by disconnecting, blinding, blanking, or using double block and bleed technology, and this section provides for an alternative manner of isolation.*

*An example of a situation where this means of isolation might apply is where an employer uses an inflatable bladder in a water line to stop the flow of water into the confined space. Another example is where, in a waterworks system, an engineered shutoff float in a chamber is used as a means to prevent water from rising to a height where it would be discharged via a pipe to a confined space. If the rate of flow could endanger workers if the float failed, a professional engineer must certify that the adjacent piping is isolated in a manner that will make the space safe.*

*Engineering certifications specifically need to address worker safety and should typically include consideration of the amount of leakage, age, and maintenance history of the piping components and any other means in place to make the confined space safe for a worker to carry out the intended work. Certifications are expected to be site specific and time limited, and the engineer will need to make the determination of the applicable time period as part of the certification process.*

*A professional engineer may not always have sufficient information about a valve that is to be used to control potential flow into the confined space and may not be able to examine it. In this case, the engineer could consider information such as the age, history, and maintenance records for the adjacent piping system, leakage rates, and measures such as leak control or line pressure reductions that can be accomplished etc.*

*Certifications by engineers under section 9.18(3)(b) will need to be available for review by a WorkSafeBC prevention officer where necessary to assess compliance with the requirements. If a prevention officer has concerns about an engineering certification under this section, the prevention officer should discuss the concerns with the WorkSafeBC Engineering Department).*

*Two common circumstances where section 9.18(3)(b) applies are public water supply systems (e.g., valve and meter chambers where work may affect the integrity of piping systems passing through the confined space) and dam water passageways.*

**Public water supply systems** provide water for domestic uses such as human consumption, food preparation, and cleaning purposes. They also provide water distribution networks for fire suppression, which are typically an integral part of public water supply systems.

*Note: In some cases, public water will be used downstream for industrial uses, for example in a process industry or a manufacturing facility. Section 9.18(3)(b) does not apply to such industrial systems if chemical additives could be present or the spaces present hazards other than just temperature (e.g., hot or cold), pressure (e.g., force of the flow), or quantity (immersion hazard).*

*The system of isolation may be one or more closed valves, use of inflatable bladders, or some other means of isolation. The professional engineer must certify that the adjacent piping is isolated in a manner that makes it safe for a worker to carry out the intended work. The engineer will need knowledge of the valves or other closure devices as well as the nature of the substance in the adjacent piping.*

**Dam water passageways:** *At a dam and associated hydroelectric station there may be a number of confined spaces, for example, fuel storage tanks, which are not part of the dam water flow system, and for which this section would not apply. The application of section 9.18(3)(b) is restricted to dam water passageways at the site.*

#### Reference:

Workers must be protected from harmful substances (solids, liquids, and gases) that could be discharged from pipes or conduits adjacent to or is leading to the confined space.

If adjacent piping contains (or has contained) a harmful substance that has the potential for entering the confined space, the substance must be controlled using isolation procedures. Isolating means ensuring contaminants inside piping will not enter a confined space. The following are means of isolating:

- **Disconnecting the pipe**
- **Inserting a blank or blind in the piping**

- **Using an equivalent engineered system to isolate the piping from the confined space**
- **Using double block and bleed system in certain circumstances**

Closing one or more valves and locking them in the “*off*” position is not considered to be adequate isolation (except when it is used as part of a double block and bleed system).

## Adjacent piping with a HARMFUL substance?

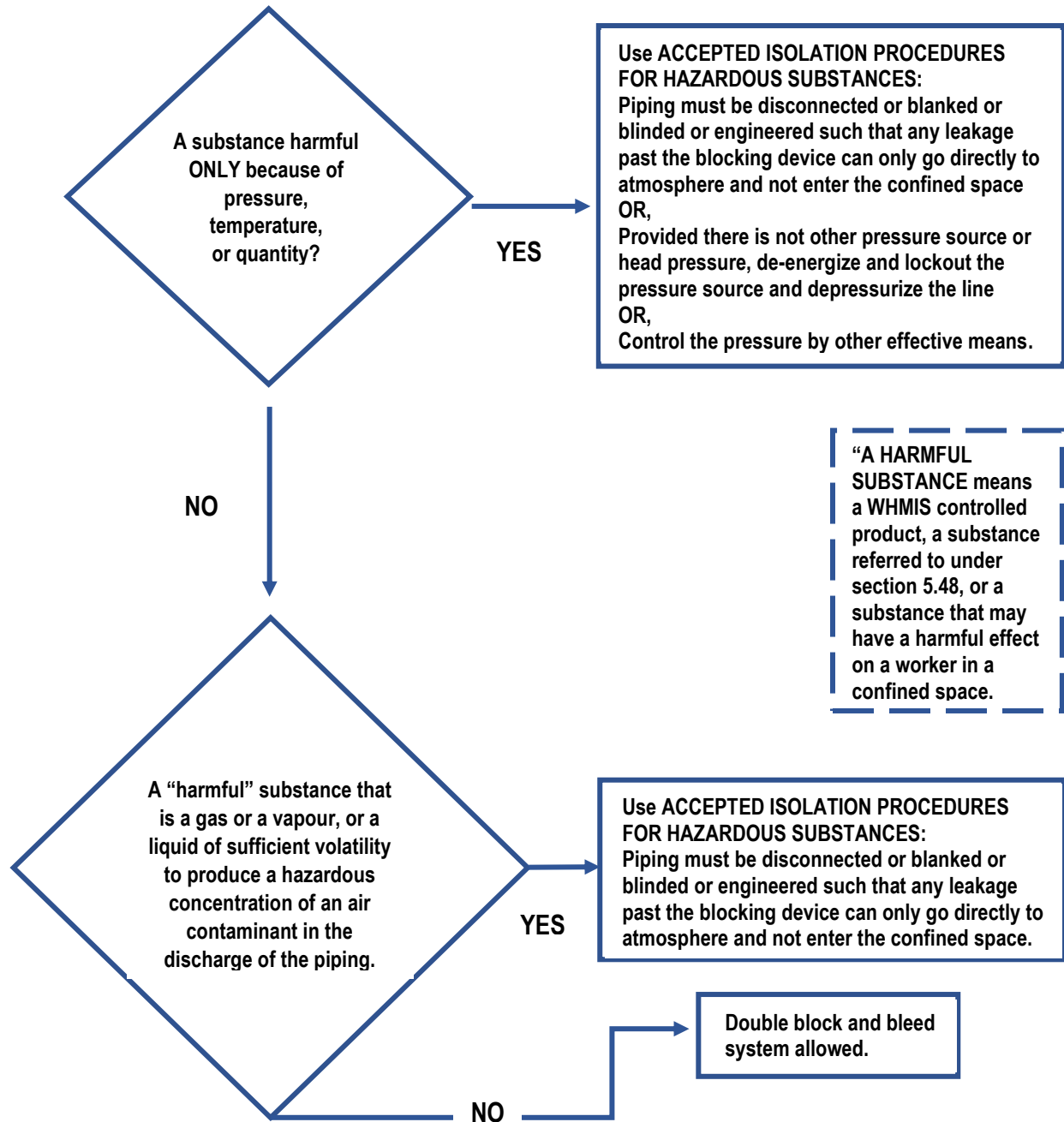

The qualified person must develop the isolation system for a specific space in accordance with the hazard assessment. When a line is disconnected or when a blank or blind is installed, workers must follow written work procedures that will prevent them from being exposed to any hazardous substance in the line. Before a worker enters a confined space, every isolation point must be visually checked or otherwise verified to ensure that the confined space is effectively isolated.

The employer must keep a record that identifies the location of every isolation point. If locks are used, the written lockout procedure must include instructions for applying and removing locks. Employers must be trained in lockout, including use of a lockout board.

## **Disconnecting a pipe**

Isolating includes disconnecting a pipe, which can be done by removing the bolts that hold the pipe flanges together or by loosening unions that connect threaded pipe sections. If the piping will be left disconnected, the sections of the pipe that have been disconnected also must be misaligned to prevent overflow material from getting into the space.

### ***9.19 Isolation points***

#### **Legislation states,**

(1) The employer must keep a record which identifies the location of every isolation point.

(2) Every isolation point must be visually checked or otherwise verified to ensure that the confined space is effectively isolated before a worker enters the space.

#### *Related Guidelines:*

*Refer to section 9.18 **Control of harmful substance in adjacent piping***

#### Reference:

The employer must keep a record that identifies the location of every isolation point. If locks are used, the written lockout procedure must include instructions for applying and removing locks. Employers must be trained in lockout, including use of a lockout board.

**Refer to section 9.18 Control of harmful substance in adjacent piping**



## **9.20 Blanks and blinds**

### **Legislation states,**

(1) Unless certified by a professional engineer to provide adequate safety for the particular conditions of anticipated pressure, temperature and service, a blank or blind must be manufactured in accordance with the specifications of one of the following standards:

(a) *ANSI Standard API 590-1985, Steel Line Blanks;*

(b) *ANSI Standard ASME/ANSI B16.5-1988, Pipe Flanges and Flanged Fittings;*

(c) *ANSI Standard ASME B31.1-1992, Power Piping;*

(d) *ANSI Standard ASME B31.3-1993, Chemical Plant and Petroleum Refinery Piping.*

(2) If a blank or blind is certified by a professional engineer, the employer must keep a record of its certification, location and conditions of service.

(3) If required, an allowance for corrosion must be made in the design of a blank or a blind.

(4) A blank or blind must be stamped with or otherwise indicate its pressure rating.

(5) If a line is to be opened for disconnection or to insert a blank or a blind, written safe work procedures must be prepared and followed to prevent hazardous exposure of workers to its contents.

(6) Visual indication that a blank or blind has been installed must be provided at the point of installation.

(7) If required to prevent leakage, gaskets must be installed on the pressure side of blanks or blinds and flanges must be tightened to make the blanks or blinds effective.

(8) If threaded lines are used, threaded plugs or caps must be used to blind the lines.

*Related Guidelines:*

Refer to section 9.18 **Control of harmful substance in adjacent piping**

Reference:

A **blank** is a solid plate installed through the cross-section of a pipe, usually at a flanged connection. A **blind** is a solid plate installed at the end of a pipe where it has been physically disconnected from a piping system. The point of installation must have a visual indication that a blank or blind has been installed.

Typically, a “spectacle” (as shown in the diagram) is used as a visual indication that a blank has been installed.

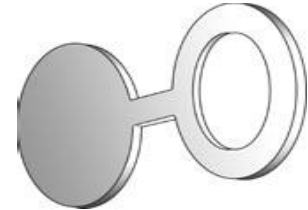

A blank or blind must be:

- Designed with an allowance for corrosion if it will be used in conditions where it can corrode.
- Stamped with its pressure rating or otherwise indicate its pressure rating.

When necessary to prevent leakage, install gaskets on the pressure side of a blank or blind. Flanges must be tightened.

A blank or blind must be manufactured according to the specifications of a standard acceptable to WorkSafeBC. Blanks and blinds not meeting these standards may be used if a professional engineer has certified that they will provide adequate safety for particular conditions of anticipated pressure, temperature, and service. If one of these alternative blanks or blinds is used, the employer must keep a record of its certification, location, and conditions of service.

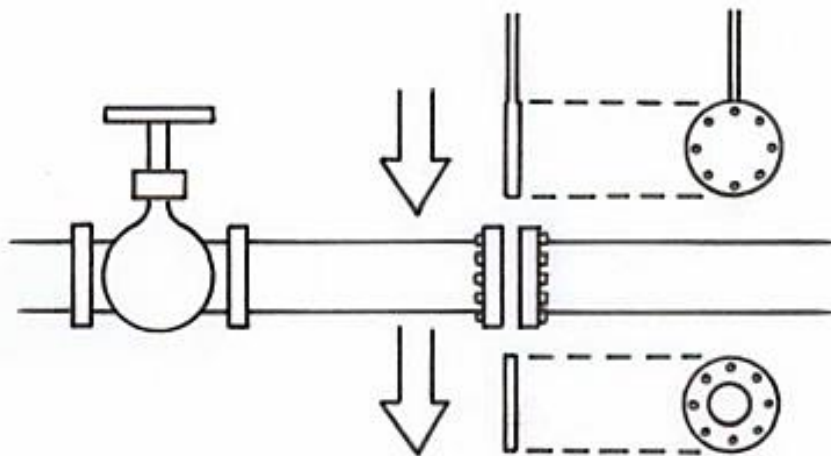

A blank must be able to withstand the pressures of the substance inside the piping system. A gasket is often inserted on the upstream side to prevent leakage.

Written procedures for blanking and blinding must be specific to the confined space, the location of the pipe, and the hazards involved. The following simple example gives basic instructions for installing a blank in a pipe carrying caustic soda. Specific instructions for the situation would be needed, such as those suggested after each step.

### **Procedure for installing a blank in a six-inch piping system carrying caustic soda**

1. Provide atmospheric testing, warning devices, and protective equipment if toxic or flammable air contaminants could be discharged at a disconnect point. (For example, wear goggles, neoprene, PVC, or rubber coveralls, gloves, and boots to protect against contact with caustic soda.)
2. Shut off the appropriate upstream valve. (For example, shut off valve #5 in the west end chamber.)
3. Apply personal lock to ensure no one will turn valve while a blank is being installed. (For example, apply lock to valve #5 by placing lock in position on valve cover.)
4. Depressurize the line. (For example, open relief valve #6.)
5. Clear the line. (For example, open drain valve #7.)
6. Remove the gasket(s) while preventing the worker from being exposed to any toxic contents that may remain in the piping system. (For example, remove gasket(s) at flange #1101. Ensure personal protective equipment is worn including goggles, neoprene, PVC, or rubber coveralls, gloves, and boots to protect against contact with caustic soda.)
7. Insert and secure the blank in the pipe.) For example, insert spectacle #25 rated for 200 psi pressure with closed end across opening of pipe.)
8. Insert a gasket on the pressure side to ensure no leaks.
9. Tighten flanges to make the blank effective.

### **9.21 Double block and bleed**

#### **Legislation states,**

If a double block and bleed isolation system is used

- (a) the diameter of the bleed line must be no less than the diameter of the line being isolated, unless certified by a professional engineer,
- (b) the bleed for a liquid system must be at a lower elevation than the block valves,
- (c) all valves must be locked out in their proper open or closed position,
- (d) the downstream block valve must be checked to ensure that it is capable of safely withstanding the line pressure,

(e) the bleed must be checked to ensure that it remains clear of obstructions while the confined space is occupied, either by continuous automatic monitoring or by manually checking within 20 minutes before worker entry, or before re-entry after the confined space has been vacated for more than 20 minutes, and

(f) in the event of discharge from the bleed line resulting from failure of the upstream block valve, all workers must immediately exit the confined space and the space must be effectively re-isolated before a worker enters the space.

Reference:

You may use a double block and bleed system if the harmful substance in the piping is not one of the following:

- A gas
- A vapour
- A liquid volatile enough to produce a hazardous concentration of an air contaminant from the discharge from the piping.

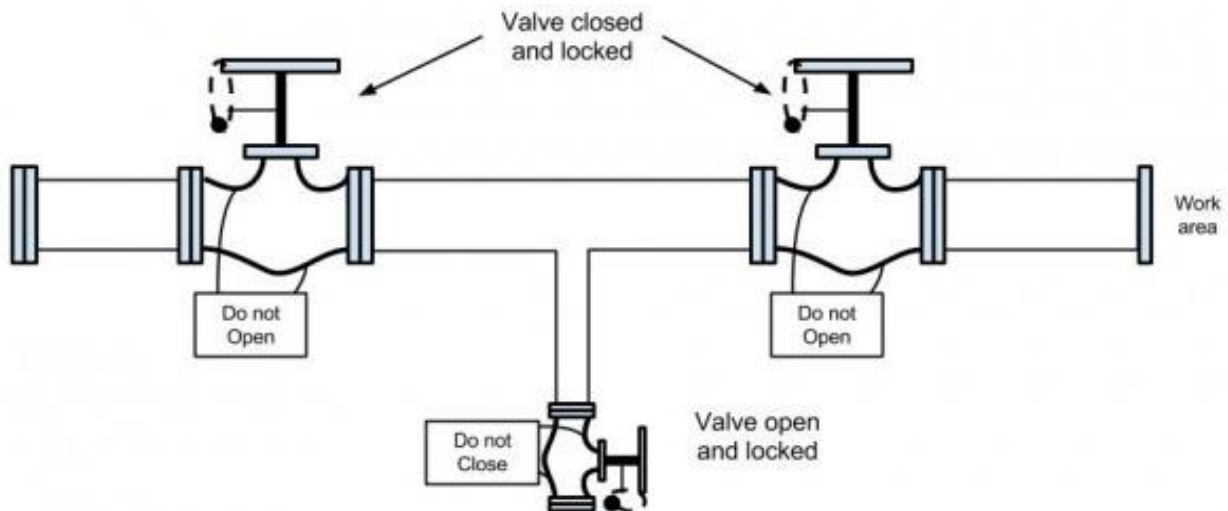

As shown above, double block and bleed involves closing valves in the piping by locking out a drain or vent valve in the open position in the line between two locked-out valves in the closed position. The written lockout procedures must identify the specific lockout points and valves by name. The names on the procedure must match the markings on the piping system.

The following requirements must be met when using double block and bleed:

- The downstream block valve must be checked to ensure that it is capable of safely withstanding the line pressure. This could be done by shutting the downstream valve first and checking to see if there is any flow.

- The diameter of the bleed line must be no less than the diameter of the line being isolated, unless an engineer certifies otherwise.
- The bleed for a liquid system must be at a lower elevation than the block valves.
- All valves must be locked out in their proper open or closed position.
- The bleed must be checked to ensure that it is clear and remains clear of obstructions while the confined space is occupied. This can be done either by continuous automatic monitoring or by manually checking within 20 minutes before worker entry (or before re-entry after the confined space has been vacated for more than 20 minutes.)
- If the bleed line discharges because of failure of the upstream block valve, there must be a system in place that notifies those who have entered the confined space. All workers must immediately exit the confined space and the pipe must be effectively re-isolated before a worker enters the space.

## ***9.22 Alternative measures of control or isolation of adjacent piping***

### **Legislation states,**

(1) Section 9.18 does not apply if

(a) a measure specified in section 9.18 to control or isolate harmful substances contained in adjacent piping from a confined space is not practicable, and

(b) the employer implements alternative measures of control or isolation that are acceptable to the Board.

(2) All workers affected by measures implemented under subsection (1) must be informed of the measures taken and instructed in any applicable work procedures.

### Reference:

If isolation using the measures outlined in this section is not practicable, the employer may implement alternative methods. Prior to undertaking the work, the alternative procedures must be submitted and accepted by WorkSafeBC. All workers affected by alternative methods must be informed of the alternative measures taken and instructed in safe work procedures.

## ***9.23 Discharge area***

### **Legislation states,**

The area of potential discharge from a disconnected line or from the bleed of a double block and bleed isolation system must be controlled to ensure that any accidental discharge will not present a hazard to workers.

# Section 6: Verification and Testing

This section discusses the verification of precautionary measures and the requirements for pre-entry atmospheric testing of a confined space.

## Learning Objectives:

1. Understand how to verify the precautions being used to mitigate identified hazards in a confined space.
2. Understand the requirement for pre-entry atmospheric testing of a confined space.

## **9.24 Verifying all precautions**

### **Legislation states,**

Before a worker enters a confined space, pre-entry testing and inspection must be conducted, to verify that the required precautions have been taken and are effectively controlling the identified hazards.

### *Related Guidelines:*

*Section 9.25 of the OHS Regulation requires the atmosphere in a confined space to be tested in a number of circumstances before a worker enters the confined space. The requirements of section 9.24 are not limited to atmospheric testing. Other hazards, such as entrapment, radiation, heat stress, noise and cold stress may also be present. These require assessment regarding the degree of risk to workers.*

*In addition, it is necessary to inspect before entry to ensure that all required controls are in place. These are similar to requirements for supervisor responsibility stated in section 9.7(2).*

## **9.25 Testing the atmosphere**

### **Legislation states,**

(1) Except as stated in subsection (7), before a worker enters a confined space, the employer must ensure that the atmosphere in the confined space is tested in accordance with this section and section 9.26.

(2) The pre-entry testing must be

- (a) conducted as specified in the written work procedures, and

(b) completed not more than 20 minutes before a worker enters a confined space.

(3) When all workers have vacated the confined space for more than 20 minutes, pre-entry testing, as required by subsection (1), must be repeated.

(4) While a worker is inside a confined space with a moderate or high hazard atmosphere, additional testing must be conducted as necessary to ensure the worker's continuing safety.

*Section 9.25(4) of the OHS Regulation states "While a worker is inside a confined space with a moderate or high hazard atmosphere, additional testing must be conducted as necessary to ensure the worker's continuing safety."*

*The intervals at which additional testing should occur depends on the outcome of the hazard assessment, the operations being performed in the space and the risk of the atmosphere changing substantially. In addition, the selection of appropriate instrumentation for testing of the space, together with the requirement of section 9.25(5) for continuous monitoring, may determine the frequency of testing that is practicable.*

(5) Whenever practicable, continuous monitoring of the atmosphere must be done.

"Practicable" is defined in section 1.1 of the *OHS Regulation* as meaning "that which is reasonably capable of being done". In determining what is "practicable", the relevant factors include:

- the availability in the marketplace of continuous monitoring devices,
- the reliability of continuous monitoring devices to detect contaminants within acceptable ranges to provide worker protection (this means in the range of the exposure limit or lower), and
- the potential for cross contamination or poisoning of the sensors for the instrumentation selected.

(6) If a worker enters a confined space with a moderate or high hazard atmosphere, the employer must continuously monitor the atmosphere if a flammable or explosive atmosphere in excess of 20% of the lower explosive limit could develop.

(7) Pre-entry atmospheric testing is not required in a confined space with a low hazard atmosphere if

(a) the location and control of the space ensures that a more hazardous atmosphere could not inadvertently develop,

(b) such testing is not required to verify the effectiveness of an isolation or other pre-entry control,

(c) prior representative sampling has demonstrated that the atmosphere within the space or group of similar spaces meets the low hazard atmosphere definition, and

(d) the written entry procedures do not require such testing.

*Related Guidelines:*

*Section 9.25(7) permits entry into low hazard atmospheres without pre-entry atmospheric testing if the conditions listed in paragraphs (a) to (d) are met. Condition (c) is that "prior representative sampling has demonstrated that the atmosphere within the space or group of similar spaces meets the low hazard atmosphere definition".*

*"Representative sampling" is acceptable if the sampling data is*

- *statistically significant,*
- *provides for the reliable determination of worker exposure, and*
- *obtained in accordance with the confidence limits stated in OHS Guideline G5.48-9.*

## **9.26 Procedures and equipment**

### **Legislation states,**

(2) Each confined space test must be carried out by a qualified person who has training and experience to calibrate, operate and monitor testing equipment and interpret readings from the testing equipment.

Section 4.3(2) states:

Unless otherwise specified by this Regulation, the installation, inspection, testing, repair and maintenance of a tool, machine or piece of equipment must be carried out

(a) In accordance with the manufacturer's instructions and any standard the tool, machine or piece of equipment is required to meet, or

(b) as specified by a professional engineer.

(3) The test record must show the date and time of the test, the initials of the tester and the levels or condition found.



(4) Test results, other than continuous monitoring results, must be posted without delay at all points of entry to the confined space.

*Related Guidelines:*

*Section 9.26(4) of the OHS Regulation states "Test results, other than continuous monitoring results, must be posted without delay at all points of entry to the confined space."*

*Continuous monitoring provides continuous feedback to the personnel entering and working in the confined space. In effect, this provides better feedback than the posting of test results at all entrances to the confined space. However, the section does not exempt the employer from recording continuous monitoring test results at appropriate intervals as required by section 9.26(3). Many instruments used for this purpose are equipped with a data logging capability that makes it easy to record test results and to interpret the data. Otherwise, readings can be manually recorded at appropriate time intervals.*

*Keeping records of continuous monitoring will be particularly important for employers wanting to eliminate pre-entry atmospheric testing for a low hazard atmosphere confined space, as it may be a source for the data required by paragraph 9.25(7)(c).*

# Section 7: Cleaning, Purging, Venting, Inerting

This section covers the cleaning, purging, venting and inerting of the atmosphere inside a confined space, to make the space safe for workers to enter and perform their work activities.

## Learning Objectives:

1. Become familiar with the terms cleaning, venting, purging and inerting.
2. Understand how a confined space is cleaned, vented, purged and inerted.
3. Understand when a respirator is required in a confined space.
4. Understand how to prevent fires and explosions within a confined space.
5. Understand the requirements for an inerted confined space.

## **9.27 Cleaning, purging and venting**

### **Legislation states,**

(1) When practicable, the employer must ensure that a confined space to be entered contains clean respirable air.

(2) If a confined space is known, or shown by pre-entry testing to contain other than clean respirable air, the hazard must be controlled by cleaning, purging or venting the space and the atmosphere must be retested before a worker enters the space.

(3) The dead-ends of a line that has been isolated must be cleaned, purged or vented to remove any harmful substance which could present a hazard to a worker entering the confined space.

### *Related Guidelines:*

*More than one cleaning, purging or venting may be required to achieve a confined space with clean respirable air. It depends on what is practicable and reasonable in the circumstances. If continued cleaning, purging or venting will further the objective of having a clean respirable atmosphere, these processes should be repeated. If continuing these processes will not effectively improve the residual atmospheric quality, then the employer may proceed with entry in accordance with section 9.28 of the OHS Regulation.*

## Reference:

This section covers the information on how to make the atmosphere inside a confined space safe for workers to enter and perform their work activities. It covers:

- Cleaning the space to remove contaminants
- Replacing an unsafe atmosphere with clean respirable air by purging and ventilating of the space
- Preventing fires and explosions
- Inerting the space
- Using continuous ventilation to keep the atmosphere safe
- Using respirators if clean respirable air cannot be maintained

The goal is to have clean respirable air in the confined space before entry. Clean respirable air is defined in terms of having sufficient oxygen, no flammable substances, and an acceptable level of air contaminants. Therefore, pre-entry testing includes tests for all three of these conditions.

If it is known or shown by pre-entry testing that a confined space does not contain clean respirable air, the hazard must be eliminated or controlled before workers enter the space. The control measures depend on the hazard. For example:

- If the atmosphere is oxygen-deficient, be sure the space is clean and replace the air with clean breathable air.
- If there is a toxic atmosphere, or there is a possibility of a toxic atmosphere from work inside the space, be sure the space is clean, and remove the contaminants and replace the air with clean breathable air.
- If the atmosphere is explosive or flammable, be sure the space is clean and replace the air with clean breathable air or fill the space with an inert gas.

The atmosphere must be retested after any of these procedures. **The goal is to ensure that the space contains clean breathable air before a worker enters** (except in the case of deliberately inerting the atmosphere). If it is not practicable to eliminate the hazard in the atmosphere, other controls such as the appropriate respirator will be needed. Even if the air tests as clean and breathable, further controls (such as ventilation) may be needed to ensure the atmosphere remains safe while workers are in the space.

## Cleaning

**Cleaning** is the removal of physical contaminants from a confined space. Cleaning should always be done prior to entry whenever practicable from outside the confined space. Here are some examples of how to clean a confined space from the outside:

- Use a vacuum and hose to remove contaminants such as sewage sludge or petrochemical sludge.
- Rake sludge from a brewery tank.
- Pressure wash the space from the outside.
- Use a tank with a drain hole in the bottom and an agitator, and continually flush the space.

The cleaning procedures and products used will be determined by the qualified person. The procedure may include team or water cleaning, neutralization, descaling, and special solvent application. High-pressure washing is often needed. Cleaning should always be done with a product that will not react adversely with any residue in the tank. Thorough cleaning will remove harmful residues. If airborne contaminants remain after cleaning, they must be removed before entry.

The qualified person will provide written procedures for:

- Cleaning the space and removing waste before entry
- Removing standing water or other liquids before entry – an extremely important precaution in the confined spaces that contain harmful atmospheres (workers could pass out and drown in small pools of liquid)
- Controlling all ignition sources – for example, cleaning equipment, lighting, communication equipment (cell phones or radio), and photography equipment – by bonding or grounding, explosion proofing, or prohibiting use where there are flammable residues
- Keeping internal combustion engines that power equipment at a safe distance away from the flammable residues
- Providing ventilation, to control air contaminants such as vapours produced by high-temperature steam cleaning or off-gassing from sludge that has been disturbed

Steam cleaning requires additional precautions. The qualified person will also consider:

- The auto-ignition temperature of the residues
- Adequate outlets to relieve pressure
- Requirements for grounding and bonding
- Prevention of heat exposure
- Safe disposal of waste water

It may be necessary to repeat cleaning to achieve a confined space with clean respirable air. If further cleaning will not be effective, the qualified person will determine if additional control measures are required.

### **Replacing the Unsafe Atmosphere with Clean Breathable Air before Entry**

If the confined space has an oxygen-deficient or toxic atmosphere, then the first control measure is to replace the atmosphere with air that is safe to breathe before any workers enter. The next step is to ensure the air remains safe while workers are inside.

**Venting** is opening a confined space to allow clean air to enter and circulate without the use of mechanical ventilation. Use of this method as a means of controlling contaminants can be authorized only by a trained and competent person and never for a space with a high-hazard atmosphere.

The minimum air flow for low-hazard atmospheres is 85 cubic metres per hour (50 cubic feet per minute) of clean breathable air for each worker in the space.

**Purging** is removing the unsafe air from the confined space and replacing it with clean breathable air prior to entry. This is commonly accomplished by blowing air into the confined space using portable mechanical ventilators. Purging is most effective if there are no contaminants being generated within the space. If there are contaminants, the space must first be cleaned and then purged.

Replacing the unsafe atmosphere before entry usually involves mechanical ventilation to blow fresh air in and continuously move it throughout the space. When no contaminants are being generated by existing conditions inside the space, blowing air into the space equivalent to five times the volume of the space will result in approximately 95% of the original air inside the space being replaced, as long as the air is blown in at a high enough speed to mix well with the air inside the space. The specific procedure written into the confined space entry program will determine the amount of air required to make a confined space safe prior to entry and while workers are inside the space.

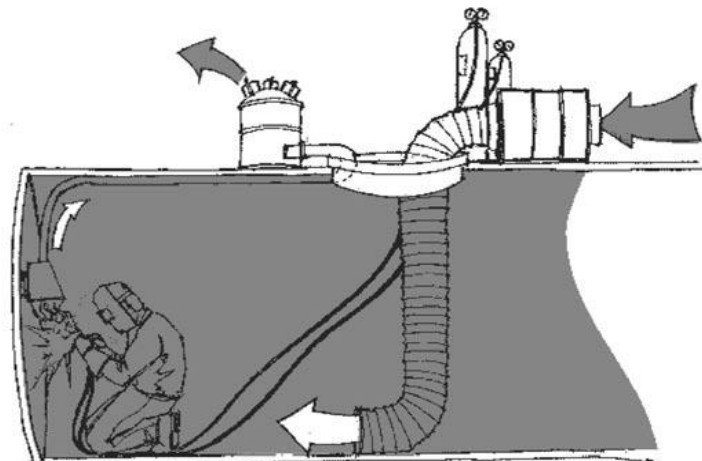

## **9.28 Risk control**

### **Legislation states,**

If clean respirable air cannot be assured in a confined space before worker entry, the employer must ensure that

- (a) all workers entering the space wear appropriate personal protective equipment including respirators when necessary
- (b) the concentrations of flammable gases and vapours are maintained below 20% of the lower explosive limit, and
- (c) if flammable or explosive gases, vapours or liquids are present, all sources of ignition are eliminated or adequately controlled.

### Reference:

The qualified person will specify the appropriate type of respirator in the written work procedures if respirators are needed for the confined space entry. If at all possible, clean respirable air should be provided before considering the need for respirators. Written procedures must also consider respirator requirements for rescue personnel.

If workers are required to use respirators, the employer must have a written respirator program covering correct selection, use, and maintenance, and must provide effective training to workers. Respirators must meet the requirements of a standard acceptable to WorkSafeBC.

Workers who are required to wear respirators must be fit tested and instructed about the requirement to wear a respirator in the confined space. A fit test involves a trained person checking for leaks at the point where the respirator seals to the face. This can be done using different methods and equipment but must be done to an acceptable standard. A written record of the fit tests must be kept for inspection.

### **Using respirators if clean respirable air cannot be maintained**

If clean respirable air in a confined space cannot be assured before workers enter, or if it cannot be maintained while workers are inside, the employer must provide the appropriate respirators for workers to safely enter and remain in the space. Respirators are to be used only if it is impracticable to provide clean respirable air or if the confined space has an inert atmosphere. In these situations, workers rely on respirators either to remove contaminants from the air they inhale or to provide a safe source of air.

If a respirator is required, the qualified person will specify in the written work procedures the type needed. All workers entering the space must wear the appropriate respirator.

If respirators are required, the employer must have a respirator program.

### **Personal Respirators**

Whenever the atmospheric concentration of a dust, vapour, mist or gas requires the use of respiratory protective equipment, an RPE policy and procedure describing the selection, use and maintenance of that equipment must be developed. The procedures contained in the RPE policy and procedure must be in writing and available to workers.



## Common misconceptions about respirators

### Misconception #1

Workers may believe they are being protected from harmful atmospheres by putting on a cartridge respirator. This may not be the case. A cartridge respirator will only protect against certain contaminants listed on the cartridge itself. Common cartridge respirators will not protect against an atmosphere with carbon monoxide, and there are no cartridge respirators that will protect against an oxygen deficient atmosphere.

### Misconception #2

Workers may believe that a single strap dust mask will fully protect them from harmful particles. This is not true. Only certain types of filtering respirators will provide enough protection against harmful particles in the air. A common type is the N95 respirator. The qualified person will provide written instructions regarding the type of respirator to wear. Always check the cartridge or the manufacturer's instructions to determine whether or not it has been designed to protect you from the hazardous substances with which you are dealing.

## Preventing Fires and Explosions

Fire prevention requires control of one or more of the three elements needed for a fire or explosion:

- flammable substances,
- oxygen, and
- a source of ignition.

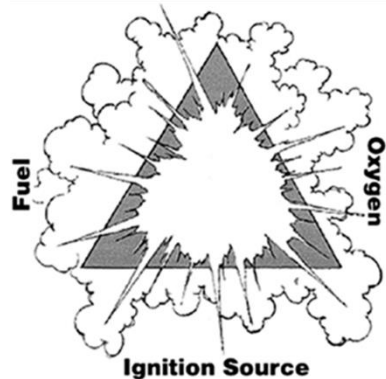

## Controlling Flammable Substances

When a space contains or may contain flammable substances, the qualified person will consider the following when developing the written work procedures:

- Minimizing quantities of flammable materials inside the space at all times.
  - Isolating the confined space from flammable substances
  - Cleaning all flammable residues prior to entry
  - Using non-flammable cleaning solvents where possible
  - Controlling any flammable materials that must be used
  - Keeping cylinders of flammable gases outside the confined space
- Wetting down spontaneously combustible residues before removal.
- Maintaining the atmosphere as far below 20% of the LEL as possible.
- Checking welding and cutting hoses.



- Removing oxyacetylene welding torches and hose assemblies from confined spaces when not in use, whenever practicable.
- Check the other side of surfaces for other workers or for combustible materials before using a torch or similar welding equipment on walls, bulkheads, etc.

### **Common misconceptions about flammability**

People sometimes have misconceptions about what levels of flammability are safe.

#### **Misconception #1**

Some employers and workers believe that if flammability is kept below 20% of the LEL in a confined space nothing more must be done to prevent fire or explosion prior to entry. This is not true.

The first approach is to eliminate any flammable vapours or gases. If this cannot be achieved, then the procedures written by the qualified person must outline that all sources of ignition must be eliminated, or adequately controlled and continuous monitoring must be in place to ensure flammable gases and vapours are maintained below 20% of the LEL.

#### **Misconception #2**

Some employers and workers believe that keeping the flammability below 20% of the LEL will give them enough warning of a toxic environment. This is not true.

Even a small increase in flammability (1%) could mean the atmosphere has become extremely toxic to breathe. For example, if the monitor reacts 1% of the LEL during use of methanol in a confined space, even though the reading of 1% is well below the flammability limit and the continuous monitor will not alarm, this concentration of methanol is three times the allowable exposure limit.

### **Preventing Oxygen Enrichment**

Air normally contains 20.9% oxygen, enough oxygen for a fire; so a higher level of oxygen increases the likelihood of material burning. Air is considered oxygen-enriched at levels above 23%. Enrichment can be caused by improper isolation of oxygen lines, ventilation of the space with oxygen instead of air, or leaks from welding equipment. To prevent oxygen enrichment, follow these precautions:

- Isolate the space from any oxygen lines.
- Never ventilate a confined space with oxygen.
- Keep cylinders of oxygen outside the confined space (except for medical emergencies).

- Remove oxyacetylene torches and hoses from the confined space when not in use, whenever practicable.

## **Controlling Sources of Ignition**

If flammable substances are present, eliminate or control all sources of ignition.

- Use electrical equipment and lighting approved for hazardous locations classified under CSA Standard C22.1-94, Canadian Electrical Code.
- Use intrinsically safe air-testing and communications equipment, cameras, or any other equipment used in the space.
- Prohibit cigarettes, matches, and lighters.
- Do not use heaters in a confined space.
- Bond steam nozzles and ventilation systems to metal structures and ground the structures.
- Use non-sparking or low-sparking tools. Non-sparking materials include leather, plastic, or wood; low-sparking metals include copper-beryllium alloy, nickel, and bronze.
- Wear non-sparking footwear (that is, no exposed shoe nails).
- Do not use internal combustion engines in the confined space unless these are approved in the written procedures (through the use of appropriate control measures).
- Where practicable, torches and hoses used for welding, brazing, or cutting must be removed.

## **9.29 Inerting**

### **Legislation states,**

(1) The employer must notify the Board in writing, and submit a copy of the proposed work procedures, at least 7 days before a worker enters a confined space which has been inerted.

(2) The employer must follow any additional precautions that are prescribed by the Board after review of the notification.

(3) If a confined space has been inerted

(a) all entry precautions for high hazard atmospheres must be followed, except the requirement for continuous ventilation,

(b) every worker entering the confined space must be equipped with a supplied-air respirator meeting the requirements of Part 8 (Personal Protective Clothing and Equipment),

(c) all ignition sources must be controlled, and

(d) the atmosphere inside the confined space must remain inerted while workers are inside.

(4) Subsection (1) does not apply to entry for the purpose of performing emergency rescue duties.

Reference:

Inerting is the process of intentionally replacing the atmosphere inside a confined space with an inert gas such as nitrogen. *Inert* means that the gas will not react or cause an explosion or fire. Inerting creates an oxygen-deficient atmosphere because the air (with its oxygen) has been replaced by another gas.

Inerting is used to eliminate hazards such as chemical reactions, flammable vapours, and the possibility of explosions. It is also used to prevent oxidation (rusting) of equipment or the walls of the confined space.

***A confined space with an inert gas is deadly.***

Every one of our body cells requires oxygen. With each breath, the oxygen is continuously supplied to each cell. One breath of an atmosphere that does not have enough oxygen will reverse this process, and the oxygen required for movement of muscles will be stripped from the cells. The first breath will make it impossible for movement, including escape.

The following requirements for an inerted confined space are essential:

- All entry precautions for high-hazard atmospheres must be followed, except the requirement for continuous ventilation.
- Every worker entering the confined space must be equipped with an SCBA or a supplied-air respirator equipped with an escape bottle. Respirators must meet the requirements of the Occupational Health and Safety Regulation, Part 18 Section 244, Personal Protective Equipment.
- The atmosphere inside the confined space must remain inerted while workers are inside.
- In the event the inert blanket is inadvertently lost, all ignition sources must be controlled.
- Escaping inert gas must not cause a hazard outside the confined space.

# Section 8: Ventilation

This section covers the topic of ventilation. It defines what ventilation means and the methods in which it is achieved.

## Learning Objectives:

1. Understand the term ventilation.
2. Understand the difference between mechanical and natural ventilation.
3. Be familiar with the two types of mechanical ventilation.
4. Be familiar with the different types of air moving devices.
5. Be familiar with the conditions under which natural ventilation cannot be used.

## **9.30 Continuous ventilation**

### **Legislation states,**

Every confined space must be ventilated continuously while a worker is inside the space, except in

- (a) an atmosphere intentionally inerted in accordance with section 9.29,
- (b) a low hazard atmosphere controlled in accordance with section 9.31(2), or
- (c) an emergency rescue, if ventilation is not practicable.

### Reference:

Ventilation is the active movement of air. It may bring clean air into a space or exhaust contaminated air out of the space. Ventilation is used to ensure that the air remains safe to breathe while workers are inside.

Confined spaces must be continuously ventilated to control hazardous atmospheres, except for certain low-hazard atmospheres, inert atmospheres, and in emergency rescue. This is most effectively done with mechanical ventilation, such as air movers, fans, and local exhaust systems. In limited situations, natural ventilation—the flow of air without mechanical assistance—is acceptable on its own. Natural ventilation is frequently used to supplement mechanical ventilation.

If mechanical ventilation is required to maintain a safe work atmosphere within a confined space, the employer must ensure that the ventilation system incorporates a method of alerting workers if the system fails. Workers must be trained in the evacuation procedures to be used if the ventilation system fails.

### **9.31 Low hazard atmospheres**

#### **Legislation states,**

(1) The employer must ensure that a minimum of 85 m<sup>3</sup>/hr. (50 cfm) of clean respirable air is supplied for each worker inside a confined space with a low hazard atmosphere, except as permitted in subsection (2).

(2) Continuous ventilation is not required in a confined space which has a low hazard atmosphere, if

(a) the atmosphere is continuously monitored and shown to contain clean respirable air, and

(b) the space has an internal volume greater than 1.8 m<sup>3</sup> (64 cu ft) per occupant, is occupied for less than 15 minutes, and the work inside the space generates no contaminants other than exhaled air.

### **9.32 Mechanical ventilation**

#### **Legislation states,**

(1) A ventilation system for the control of airborne contaminants in a confined space must be designed, installed and maintained in accordance with established engineering principles and must be specified in the written procedures.

(2) Ventilation equipment must be located and arranged so as to adequately ventilate every occupied area inside the confined space.

(3) If a contaminant is produced in a confined space, it must be controlled at the source by a local exhaust ventilation system if practicable, by general (dilution) ventilation, or by a combination of both.

(4) If practicable, a mechanical ventilation system for a confined space must be sufficient to maintain concentrations of airborne contaminants below the applicable exposure limits.

## Reference:

The two main types of mechanical ventilation are:

- Local exhaust ventilation
- General ventilation

**Local exhaust ventilation** uses exhaust fans or ducts to remove contaminated air at its source before it has a chance to spread throughout a confined space. Local exhaust ventilation is useful where air contaminants are generated from a point source, for example, at a waste sump, during welding or concrete grinding operations.

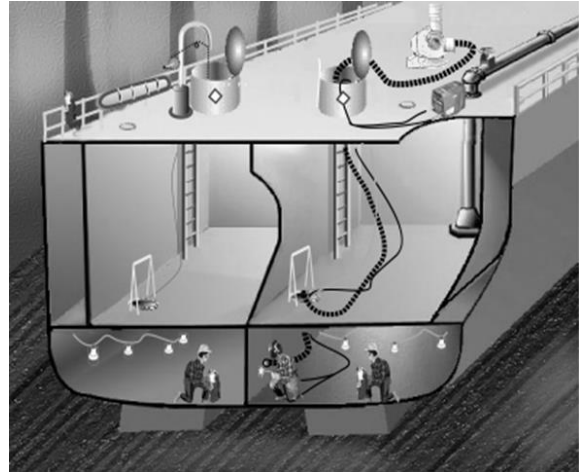

Local exhaust ventilation is generally used to supplement general ventilation.

**General ventilation** uses mechanical equipment such as fans, blowers, and ducting to deliver clean air into a space or to remove contaminated air from a space. General ventilation is sometimes referred to as “dilution” ventilation or positive-pressure ventilation. When air is blown into a space, air currents are created and the outside air mixes with air in areas that might normally have stagnant air. The faster the air moves, the more air mixing will occur. As the mixed air exits the space, contaminants are carried out. To ventilate a long space, you may need a ventilator that draws air out at one end and another ventilator that pushes air in at the opposite end. Ventilators that draw air out of a space minimize air currents and therefore reduce the possibility of generating dust.

## **Air-Moving Devices**

There are two types of air-moving devices commonly used to purge or ventilate confined spaces:

- Fans
- Venturi eductors

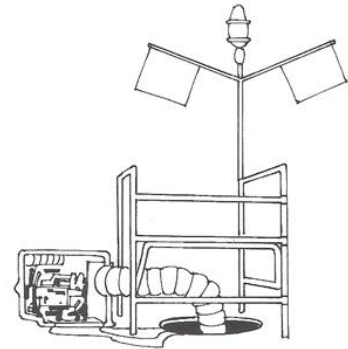

**Fans** are usually electrically powered and can be divided into two main types: axial and centrifugal. As a general rule, axial fans are used for higher flow rates in systems with lower resistance. Centrifugal fans are used for lower flow rates in systems with higher resistance.

**Eductors** (also known as air horns, air blowers, and air ejectors) operate with compressed air on the principle of the venturi effect. Eductors have the advantage of

fitting into small openings and have no moving parts. Usually, they are unable to move large volumes of air. A sufficient volume of compressed air and enough pressure are needed to achieve rated flow rates.

### **9.33 Natural ventilation**

#### **Legislation states,**

(1) If natural ventilation is relied upon for the control of airborne contaminants in a confined space, the rate of airflow through the space must be monitored and must be sufficient to maintain concentrations of airborne contaminants below the applicable exposure limits.

(2) Natural ventilation must not be used

(a) to ventilate a confined space that has a high hazard atmosphere, or

(b) if such ventilation could draw air other than clean respirable air into the confined space.

#### Reference:

Natural ventilation is ventilation of a space by natural air movement resulting from wind or convection currents. Using natural ventilation is prohibited as a control measure in the following situations:

- If a confined space has a high-hazard atmosphere
- If natural ventilation could draw air other than clean breathable air into the confined space

The qualified person will provide written work procedures that identify where and when natural ventilation can be used to maintain clean breathable air in a low-hazard atmosphere. Under these circumstances, the air flow must be monitored. In addition to continuously measuring the amount of air that is flowing through the space, workers must continuously monitor the atmosphere using a gas monitor to make sure the space contains clean respirable air.

# Section 9: Standby Persons

This section covers the role and duties of standby persons in relation to confined spaces and the atmospheric conditions under which standby persons must be used.

## Learning Objectives:

1. Understand the role of a standby person.
2. Understand the duties performed by a standby person.
3. Understand the differences between low, moderate and high hazard atmospheres.
4. Understand the different requirements standby persons must meet in relation to low, moderate and high hazard atmospheres.

This section covers the information on the duties of standby persons and the different requirements for confined spaces with atmospheres rated as low, moderate, and high hazard.

For every confined space entry, a worker must be assigned as a standby person, who monitors the well-being of workers inside the space by visually observing them or using another method of checking. The standby person also summons help in the event of an emergency. Workers inside the space must be able to contact the standby person at any time, either through voice or visual contact. The standby person must be stationed outside the confined space, never inside.



The location and functions of the standby person differ, depending on whether the hazard assessment gave the atmosphere a hazard rating of low, moderate, or high.

*Sections 9.34 to 9.36 of the OHS Regulation require that, whenever a worker enters a confined space, another worker or workers must be assigned as the standby person(s).*

*Depending on the rescue procedures, a stand-by person may also be trained and serve as a rescue person for the purpose of sections 9.37 to 9.41(3) of the OHS Regulation. In accordance with section 9.41(3), the stand-by person may not enter the space to effect rescue until at least one other worker is present and prepared to render assistance to the rescue worker.*



### **9.34 Low hazard atmosphere**

#### **Legislation states,**

If a worker enters a confined space which contains a low hazard atmosphere

- (a) another worker must be assigned as a standby person,
- (b) there must be a continuous means of summoning the standby person,
- (c) the standby person must check on the well-being of workers inside the space at least every 20 minutes, and
- (d) the standby person must have a means to immediately summon rescue personnel.

#### *Related Guidelines:*

*The requirement for low hazard atmosphere confined spaces in section 9.34 allows the stand-by worker to effectively serve as a person-check for a worker working alone in the space. The standby person does not have to be located at or near the entrance to the space if there is a "continuous means of summoning the standby person". However, the standby person cannot be located inside the confined space. The stand-by person must check on the well being of the worker inside the confined space every 20 minutes or more frequently if required by the entry procedures.*

#### Reference:

#### **In a low-hazard atmosphere:**

There must be a means for workers inside the confined space to summon the standby person at all times. Radio or telephone contact, or other means, can be used.

### **9.35 Moderate hazard atmosphere**

#### **Legislation states,**

If a worker enters a confined space which contains a moderate hazard atmosphere

- (a) another worker or workers must be assigned as the standby person(s),
- (b) a standby person must be stationed at or near the entrance to the space,
- (c) the standby person must visually observe or otherwise check the well-being of the worker(s) inside the space, as often as may be required by the nature of the work to be performed, but at least every 20 minutes,

(d) there must be a continuous means of summoning the standby person from inside the space, and

(e) the standby person must have a means to immediately summon rescue personnel.

*Related Guidelines:*

*A moderate hazard atmosphere confined space requires a stand-by person to be located at or near the entrance. See also OSH Guideline G9.34-1.*

Reference:

**In a moderate-hazard atmosphere:**

- The standby person may have other duties if they do not interfere with remaining at or near the entrance and checking on the well-being of workers.
- Workers inside the confined space must be able to summon the standby person at all times.
- The standby person must check on the well-being of the workers at least every 20 minutes, or more often if the nature of the work requires it.
- The standby person must have a means of summoning rescue personnel.

**9.36 High hazard atmosphere, engulfment or entrapment**

**Legislation states,**

If a worker enters a confined space which contains a high hazard atmosphere, a risk of engulfment or entrapment or with any other recognized serious health or safety hazard

(a) another worker or workers must be assigned as the standby person(s),

(b) the standby person(s) must be stationed at the entrance to the space and must continuously attend to the standby duties,

(c) the standby person(s) must visually observe or otherwise continuously monitor the well-being of the worker(s) inside the space,

(d) there must be a continuous means of summoning the standby person(s) from inside the space,

(e) the standby person(s) must be equipped and capable of immediately effecting rescue using lifting equipment if required, or otherwise performing the duties of rescue persons, and

*Related Guidelines:*

*Wherever possible, rescue procedures and plans should rely on rescue of workers in a manner that does not require additional personnel to be placed at risk. For example, rescue from outside the space using lifting devices, and the stand-by worker as the rescue worker, puts no rescue workers at risk. In addition, rescue without entry would not necessarily require an additional rescue worker to render assistance under section 9.41(3).*

*The means of supplying rescue services are part of the hazard assessment under section 9.9 and covered by the written procedures under sections 9.5 and 9.10*

(f) the standby person(s) must prevent the entanglement of lifelines and other equipment.

*Related Guidelines:*

*A high hazard atmosphere confined space requires the stand-by person to be stationed at the entrance to the space and dedicated to the task of monitoring the workers in the space. The standby worker cannot have other duties. See also OHS Guideline G9.34-1.*

Reference:

In a **high-hazard atmosphere** or where there is a risk of engulfment or entrapment, or any other serious health or safety hazard:

- Workers inside the space must be able to summon the standby person at all times.
- The standby person must be equipped and capable of immediately initiating rescue, using lifting equipment if required, or otherwise perform the duties of a rescue person.
- The standby person must be trained in rescue procedures.
- The standby person must prevent the entanglement of lifelines and other equipment.
- The standby person must have a means of summoning rescue personnel.

Standby persons are not permitted to enter the space for rescue purposes unless they have rescue training and only if another worker is located outside to render assistance.

A first aid attendant sometimes needs to enter a confined space to attend to a worker with injuries such as a cut or broken ankle. If the standby person is also the first aid attendant, the standby person must ensure that another fully trained standby person takes over before entering the space to provide first aid.

# Section 10: Rescue

This section covers information on legislative requirements as related to confined space rescue, the responsibilities of rescue personnel, rescue procedures and required rescue equipment.

## Learning Objectives:

1. Understand the legislative requirements as they pertain to confined space rescue.
2. Understand what is meant by the phrase rescue plan.
3. Be familiar with the elements that should be addressed in a written rescue procedure.
4. Be familiar with recommended emergency response procedures.

Confined spaces have limited or restricted access that may make rescue difficult. There must be written rescue procedures for confined spaces. This section covers the information on the responsibilities of rescue personnel and on rescue procedures and equipment.

Some employers believe that having a good rescue team is the most important part of a confined space entry program. A rescue team and rescue procedures should not be used as a substitute for making a confined space safe to enter. It is essential that the air is safe to breathe before entry so that a rescue team is not required, except for serious injuries or medical emergencies.

Studies have shown that over 60% of confined space deaths occur among would-be rescuers. Rescue plans and proper training for rescuers must be in place before any confined space entry. This will prevent well-meaning workers who are untrained in rescue from entering confined spaces to assist workers in distress and themselves becoming victims.

## **9.37 Provision of rescue services**

### **Legislation states,**

- (1) The employer must provide for the services of rescue persons when a worker enters a confined space.
- (2) If the rescue persons are employees of another firm, or an agency such as a fire department, there must be a written agreement detailing the services that are to be provided.

## **9.38 Equipment and training**

### **Legislation states,**

- (1) Every person assigned rescue duties must be properly equipped and adequately trained to carry out such duties.
- (2) A practice drill must be conducted at least annually.
- (3) Records of training and practice drills must be maintained by the employer of the rescue persons.

### Reference:

A rescue plan includes practicing the plan. This helps to ensure that personnel, equipment, and procedures are in place to affect rescue. The written rescue plan provides a step-by-step means of ensuring all possibilities are considered. Practicing the plan provides information about where improvements must be made. For example, the plan may state that a gurney will be used to remove workers from a confined space. Practice may reveal that the stretcher will not fit into the space, the workers cannot lift the injured worker from inside the space, or the winch apparatus needs to be replaced. The more often the rescue plan is practiced, the less likely something will go wrong if a rescue is required. A practice drill should be held at least once each year.

If rescue cannot be effected by the standby person(s) using harnesses, lifelines and lifting equipment, then one or more additional workers must be stationed at the entrance to the confined space and these workers must be equipped and capable of entering the space and effecting rescue.

Every person assigned rescue duties must be properly equipped and adequately trained to carry out these duties. Employers may use their own trained workers or another firm or agency. In such cases, there must be a written agreement detailing the services to be provided. If additional rescue services may be required, there must be prior planning and pre-entry discussions with the rescue services.

Records of training and practice drills must be maintained by the employer of the rescue persons.

## **9.39 Notification**

### **Legislation states,**

- (1) Before a worker enters a confined space, the responsible supervisor or the standby person must notify rescue personnel of work in the space.
- (2) The responsible supervisor or the standby person must notify rescue personnel when all workers have completed their work and exited from the space.
- (3) If more than one confined space is to be entered at the same time, notification of rescue personnel to be on alert status at the commencement of work is adequate.

### *Related Guidelines:*

*In determining the rescue services to be provided, the employer should assess the risks from workers entering into more than one space entry at the same time. If the rescue services are called upon for one space, and there is insufficient rescue capacity to deal with emergencies in other confined spaces at the same time, the employer must terminate the entry or use of workers in other spaces during the rescue operations.*

*Examples of industries that may involve several confined space entries at the same time are petroleum refineries, pulp mills, tank and rail car cleaning operations and bulk storage facilities.*

- (4) Notification requirements in this section do not apply if the written agreement indicates that rescue personnel are available 24 hours each day.

### Reference:

**Note:** Notification requirements do not apply if a written agreement with the rescue agency indicates that rescue personnel are available on a 24-hour basis.

## **9.40 Summoning rescue**

### **Legislation states,**

The employer must ensure that rescue personnel monitor any signaling system that will be used to summon the rescue persons in the event of an emergency whenever they have been informed by the responsible supervisor or the standby person that a confined space entry is in progress.

### Reference:

The employer must ensure that rescue personnel are monitoring any signaling system that will be used to summon them in an emergency. The employer must ensure rescue

procedures include every possible means of eliminating, controlling, or reducing the risk to emergency personnel, including the use of mechanical ventilation.

All employers are responsible for the provision of first aid equipment, supplies, facilities, and services, as determined by an assessment that would meet the requirements of the Occupational Health and Safety Regulations.

## **9.41 Rescue procedures**

### **Legislation states,**

(1) Rescue or evacuation from a confined space must be directed by a supervisor who is adequately trained in such procedures or a qualified rescue person.

(2) Effective voice communication must be maintained at all times between workers engaged in the rescue or evacuation and the person directing the rescue.

(3) A rescue worker must not enter a confined space unless there is at least one additional worker located outside to render assistance.

(4) A self-contained breathing apparatus, or air supplied respirator with escape bottle, must be used during rescue operations in an unknown or IDLH atmosphere.

**Note:** Rescue procedures must apply every possible effort to eliminate, control or reduce the risk to emergency personnel responding to emergency situations including the use of mechanical ventilation.

### *Related Guidelines:*

*The stand-by person required by sections 9.34 to 9.36 may serve as a rescue worker, or as the backup worker required by section 9.41(3), provided the person is properly trained and adequately equipped. Where this occurs, the confined space rescue situation will involve a minimum of 3 people: The worker in the confined space needing rescue, the standby/rescue worker, and a third worker to meet the requirements of section 9.41(3). Four or more persons may be required if the standby person does not serve as one of the rescue workers required by section 9.41(3).*

### Reference:

The person who directs the rescue or evacuation must be adequately trained in such procedures and must be in voice communication at all times between the person directing the rescue and the workers who are performing the rescue.

Trained rescue workers will know how to conduct a rescue and will consider the following:

- Additional workers located outside to assist
- Rescue from the outside (if possible)
- Requirements for use of a safety harness and lifeline

Trained rescue workers will also know that if IDLH conditions exist or could develop, they must enter only with an SCBA or supplied-air respirator equipped with an escape bottle. Small-diameter openings will require special consideration for rescue workers who are encumbered with SCBA apparatus. A key objective is to correct atmospheric hazards prior to entry and supply adequate ventilation to ensure a safe atmospheric environment whenever practicable.

### **Written procedures for rescue**

Written procedures for rescue must be in place before every confined space entry. The procedures will consider:

- All hazards of the space as specified in the hazard assessment
- Dimensions of the space, location of entry and exit points, and obstacles to removing an injured worker
- Rescue equipment required for each space
- Personal protective equipment for rescuers, including appropriate respirators for any contaminants or IDLH conditions
- Communication between workers, rescuers, the supervisor of the entry, and standby persons
- Procedures to follow immediately after an incident has occurred
- Possible hazards that may arise during rescue, the appropriate evaluation of these hazards, and control methods recommended by a qualified person
- Rescue methods for a worker who is unconscious, unresponsive (on or off of a lifeline), or distressed.



## Recommended Emergency Response Procedures

- Activate Emergency Response Plan
- Assess the Situation
- Initiate Rescue
- Provide Basic Life Support
- Transfer to Medical Aid
- Terminate Response
- Debrief

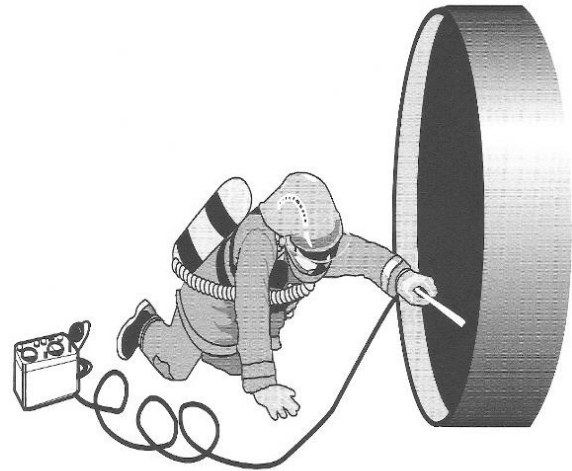

### Contact protocols

Do not rely on a call to 911 to provide the rescue services unless you have a specific written agreement with your local public emergency service provider. You are required to prearrange any rescue services. However, if you unimpededly find you need additional medical or rescue services (911), then the contact person must be prepared as much information as possible in order to inform the responders who will be attending the emergency.

- **Exact location:** if the address is hard to find, provide easy access instructions – for example, “from the intersection of Highway 10 and Main street, follow route 7 for 3 km and then turn left at the crossroads”.
- **Exactly what was being done and what happened to the worker:** Not all people understand specific names or equipment, such as a: batch digester”. So, simplify the description without losing the necessary information. For example, “the worker was applying a coating inside a tank and he lost consciousness and fell off a 2-metre-high platform”.
- **State what you need:** for example, “we require a hazmat team, a rescue team, and emergency medical services”.

Not all fire departments have the equipment or the training necessary to enter confined spaces to rescue someone. It is essential that employers pre-plan rescue with a rescue services provider.

# Section 11: Lifelines, Harnesses and Lifting Equipment

This section covers information on legislative requirements as they relate to the equipment used for confined space rescue.

## Learning Objectives:

1. Be familiar with the equipment used for confined space rescue.

## **9.42 When required**

### **Legislation states,**

(1) When entering a confined space which contains a high hazard atmosphere, a risk of entrapment or engulfment or with any other recognized serious health or safety hazard, the worker must wear a harness of a type which will keep the worker in a position to permit rescue.



(2) A lifeline must be attached to the harness and be tended at all times by a standby person stationed outside the entrance to the space.

(3) The standby person must be equipped with suitable lifting equipment if necessary, to permit rescue.

(4) The use of a lifeline is not required if the risk assessment identifies obstructions or other conditions that make its use impractical or unsafe.

### *Related Guidelines:*

*"Risk assessment" refers to the "hazard assessment" done under section 9.9.*

### Reference:

Lifelines, harnesses, and lifting equipment must meet the requirements of standards acceptable under the Occupational Health and Safety regulation. All rescue personnel must be trained in the use of all required equipment.

Harnesses and lifelines are required in confined spaces entries with a high-hazards atmosphere, with a risk of entrapment or engulfment, with any other recognized serious

health or safety hazard, or if required by the written procedures. The standby person must be able to lift the person out using the lifting equipment provided, and the worker inside must wear the type of harness that will keep the worker in a position to permit rescue.

If there is a possibility that rescue will be required from an IDLH, oxygen-deficient atmosphere, or an unknown atmosphere, the qualified person and the rescue services provider will discuss any requirements for SCBA or supplied-air respirator.

## **Rescue equipment**

### **Harnesses**

The type of harness depends on whether the worker must be rescued in a vertical direction or otherwise. If the rescue is anything other than vertical rescue, the qualified person will consider the equipment required.

In a vertical rescue, a full-body harness must be used to keep the worker in an upright position. Safety harnesses with leg, waist, and shoulder straps must meet the requirements of standards acceptable to WorkSafeBC.

### **Lifelines and connections**

Select lifelines for strength, chemical stability, abrasion resistance and, where high voltages may be encountered, electrical resistance. For example, nylon has good breaking strength and abrasion resistance, but may not be a good choice around high voltages because of its ability to absorb moisture.

Lines must be free of knots and splices (except at the ends) and must be securely anchored. Connections to harnesses should be made with locking snaphooks or a locking-type carabiner.

### **Lifting equipment**

Lifting-assist devices include the following:

- A worker-rated hand winch with a dog-action brake or a block and tackle to provide mechanical assistance, capable of both lifting and lowering,
- A powered winch, when the length of lift is substantial, capable of both lifting and lowering, and with an effective means of control that has been tested before use
- Edge rollers to protect the lifeline from abrasion where the line encounters sharp edges
- A rope grab, brake bar, or other similar device to help prevent return slippage

### **9.43 Standards**

#### **Legislation states,**

Harnesses, lifelines and lifting equipment must meet the requirements of standards acceptable under this Regulation.

#### *Related Guidelines:*

*This primarily refers to the standards accepted under parts 4,8,11 and 32 of the OHS Regulation.*

### **9.44 Line entanglement**

#### **Legislation states,**

If one or more workers enter a confined space, provision must be made to prevent the entanglement of lifelines and other equipment.

### **9.45 Additional workers**

#### **Legislation states,**

If rescue cannot be effected by the standby person(s) using harnesses, lifelines and lifting equipment, then one or more additional workers must be stationed at the entrance to the confined space and these workers must be equipped and capable of entering the space and effecting rescue.

# Section 12: Personal Protective Equipment and Other Precautions

This section covers the information on the general responsibilities for personal protective equipment (PPE) and a brief description of a respirator program.

## Learning Objectives:

1. Be familiar with the items of personal protective equipment required for working within a confined space.
2. Be familiar with the factors to be considered when determining the appropriate level of respirator use.
3. Be familiar with the legislative requirements as they pertain to torches and hoses within a confined space.
4. Be familiar with the legislative requirements as they pertain to electrical equipment within a confined space.
5. Be familiar with different types of non-sparking tools.
6. Understand the concept of coordination of work activities.

### ***9.46 Personal protective equipment***

**Legislation states,**

Repealed

The employer must ensure that all workers who may be exposed to danger in or around a confined space are provided with appropriate personal protective equipment (PPE). The supervisor of the entry must ensure the workers wear such equipment. (Workers may be required to provide their own safety footwear and headgear.)

The competent person who prepares the hazard assessment and written work procedures will specify the PPE needed for each confined space (or group of similar spaces) and for the work activities that occur there. There may be different PPE requirements for workers inside the confined space, rescue workers, and standby persons.

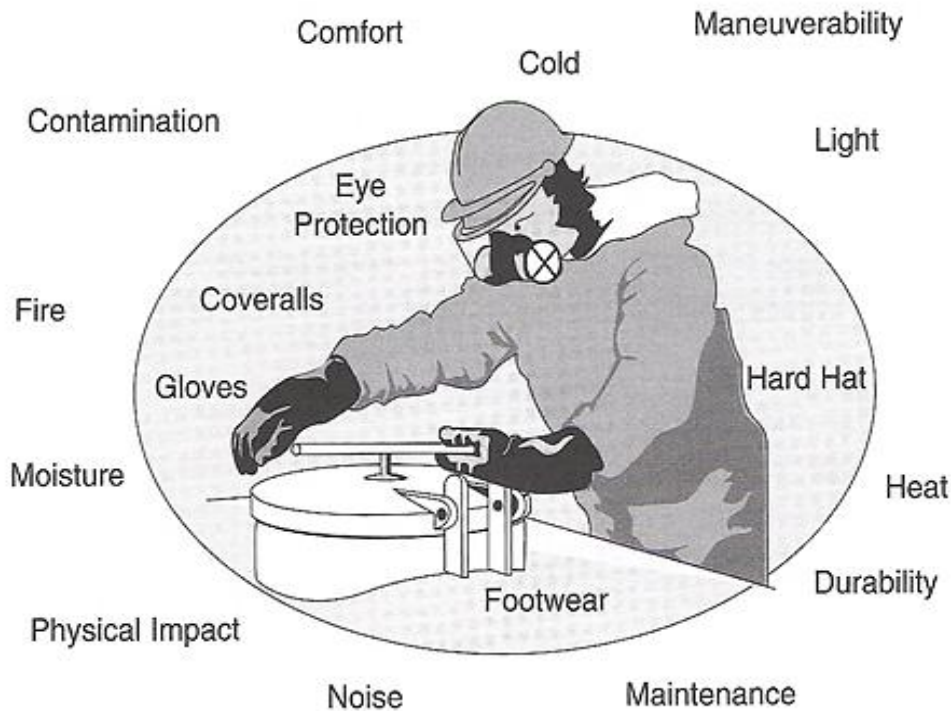

General requirements for personal protective equipment include the following:

- All equipment must be used and maintained in accordance with the manufacturers' instructions. Equipment must be inspected regularly and kept in good working order.
- Workers must be instructed and trained in the use, limitations, and assigned maintenance duties of personal protection equipment so that they can use the equipment correctly.

### **9.47 Emergency escape respirator**

**Legislation states,**

Workers entering a confined space which contains a high hazard atmosphere must carry on their person or have within arm's reach an emergency escape respirator sufficient to permit them to leave the confined space without assistance.

*Related Guidelines:*

*The selection and use of appropriate escape respirators for high hazard atmosphere confined spaces must be in accordance to the requirements of part 8 of the OHS Regulation, particularly section 8.36.*

Reference:

### **Breathing Apparatus**

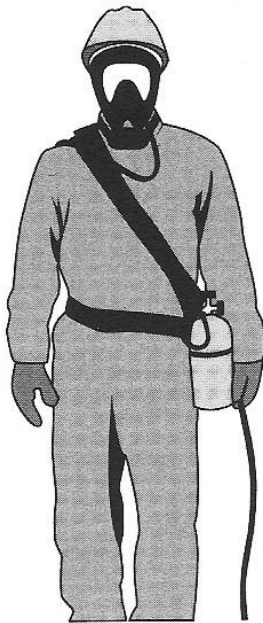

Supplied Air Breathing Apparatus (SABA)



Self Contained Breathing Apparatus (SCBA)

Legislation states that workers have several obligations. Workers must use PPE according to the training and instruction they receive. Workers must inspect PPE prior to use and not use PPE found to be in a condition that makes the PPE unsuitable for use. For example, if a worker required to use a self-contained breathing apparatus (SCBA) cannot get a good facial seal because the face piece is too small, the worker must not use the apparatus. Workers are required to report this situation to the employer so that it can be corrected.

The CSA Standard requires that workers who use respirators be free from any physiological or psychological condition that may prevent them from using a respirator. In other words, the worker must not have a medical condition that, when combined with respirator use, could endanger his or her health and safety at the worksite.

Evaluation of a worker's medical fitness to wear a respirator must be done before the worker is fit tested. The evaluation should be appropriate to the level of respirator use and take into consideration

a) the type of respirator being used,

- b) the type and concentration of contaminant the worker will be exposed to,
- c) the amount of time that the respirator must be worn, and
- d) the activities the worker must do while wearing a respirator.

### **9.48 Compressed gas cylinders**

#### **Legislation states,**

A cylinder of compressed gas is not permitted inside a confined space, except for a cylinder of compressed air supplied to a respirator, medical resuscitation equipment, handheld aerosol spray containers, fire extinguishers, or other equipment permitted by the Board.

### **9.49 Torches and hoses**

#### **Legislation states,**

When practicable, torches and hoses used for welding, brazing or cutting must be removed from a confined space when not in use and when the confined space is vacated.

#### *Related Guidelines:*

**Note:** *It may be impracticable to remove hoses for some short duration breaks of 60 minutes or less, particularly where the confined space is large or where the removal of hoses may create some risk to workers, for example, when hoses are removed from scaffolding. If removal is impracticable, alternate measures must be adopted under sections 9.4 and 9.5. The preferred method in most cases is to disconnect at source with safe venting procedures together with procedures to ensure no inadvertent reconnection while workers are on the break or, if this is not practicable, closing and putting a tag on connections located outside the confined space. Other applicable requirements in Part 9 must also be followed including those on ventilation, standby persons and retesting prior to re-entry.*

*The intent of section 9.49 is to minimize the possibility of oxygen and/or fuel gas accumulating in the confined space due to leaks or improperly closed valves. Gas can accumulate rapidly in a confined space and present a high risk of fire or explosion when workers return to the space to resume work. An action such as lighting a torch could result in a catastrophic explosion and fire. Hence, when using an oxy-fuel process in a confined space, the priority is to remove the hose and torch from the confined space upon completion of the work or whenever the worker using the equipment leaves the confined space.*



*Due to the lay-out, size, and complexity of some confined spaces and the number and lengths of oxy-fuel hoses involved, removal of torches and hoses is not always practicable for short duration breaks (such as for coffee or lunch; typically, a maximum of 60 minutes). Examples of confined spaces where removal may be impracticable include a pulp mill recovery boiler and a workspace inside the hull of a large ship berthed for repairs in a shipyard. For the latter, oxy-fuel hoses are typically fed from the dock (the usual location of the regulator/manifold), over the sides of the ship, along the deck, and extended down into the ship, to the workspace. Depending on the work required on a large vessel, many (5-15) oxy-fuel hoses may be required, each extending up to 45 metres (150 feet) in length.*

*Where it is not practicable for a worker to remove an oxy-fuel hose and torch from a confined space when taking a short break, the following protocol is acceptable, when it forms part of a confined space entry program (see section 9.5 of the OHS Regulation).*

- Prior to leaving for a break, the torch is shut off by the worker and left in the confined space.*
- The worker leaves the confined space and goes directly to the manifold or regulator.*
- The worker shuts off the oxy-fuel lines supplying the worker's torch.*
- The worker disconnects both lines from the manifold or regulator, in a manner that ensures bled-off fuel gas and oxygen from the hoses is released into an open, well-ventilated area with no sources of ignition in the immediate vicinity.*
- Lines left disconnected should be protected from contamination, if necessary.*
- Upon return from the break, the worker reconnects and charges the hoses.*
- Before a worker re-enters the confined space to resume work:*
  - 1. the confined space is tested (as required by section 9.25),*
  - 2. the mechanical ventilation system is functioning (as required by section 9.30),*
  - 3. the standby person is ready (as required by sections 9.34 to 9.36), and*
  - 4. rescue provisions are in place (as required by sections 9.37 to 9.41).*

*Torches and hoses should be shut off and removed from the confined space when this equipment will not be used for an extended time, such as breaks beyond 60 minutes or overnight, or upon completion of the work.*

## **9.50 Electrical equipment**

### **Legislation states,**

(1) Electrical tools and equipment used in a confined space must be grounded or double-insulated and so marked, and if wet or damp conditions exist inside the space, must be protected by an approved ground fault circuit interrupter as required by Part 19 (Electrical Safety).

(2) Electrical tools and equipment used in a confined space where flammable vapours of explosive gases, or liquids are present must be CSA approved for hazardous locations classified under CSA Standard C22.1-94, Canadian Electrical Code Part 1, as Class 1, Division 2, Groups A, B and C.

### Reference:

If wet or damp conditions exist inside the confined space, electrical tools and equipment must be protected by an approved ground fault circuit interrupter or other acceptable means of protection. It is always better to substitute equipment that will not be hazardous inside the confined space.

## **9.51 Non-sparking tools**

### **Legislation states,**

Only non-sparking tools may be used in a confined space where flammable or explosive gases, vapours or liquids are present.

### Reference:

### **Pneumatic Tools**

In some cases, the potential for electrical hazards can be eliminated by substituting pneumatic equipment such as air-driven grinders and sanders. If these pneumatic tools present a risk of exposure to hazardous contaminants from the exhaust, the compressor system must be located in an area where the exhaust will not contaminate the air inside the space.

If other utility lines are being used adjacent to the confined space (for example, lines containing gases such as nitrogen, acetylene, or oxygen), precautions must be taken to prevent the pneumatic tools from being attached to those lines.

## **Grounded Tools**

Properly grounded hand tools are equipped with a means of directing a ground fault back to the service entrance panel where it will blow a fuse or trip a circuit breaker. If properly grounded tools are not used, the resulting shock could be severe or even fatal.

## **Double-Insulated Tools**

Double-insulated tools are housed in a non-conductive plastic casing with a non-conductive on-off switch, which prevents the operator from coming in contact with any metal parts.

## **Ground Fault Circuit Interrupter (GFCI)**

A ground fault circuit interrupter is a type of circuit breaker that detects any difference (greater than 5 milliamps) between the current being supplied to a tool and the current that returns from the tool. If this difference is detected, the circuit breaker shuts off the flow of electricity. If the difference between the flow of electricity to and from the tool was because it was passing through a person, the person would be protected from any further current flowing through them by the ground fault circuit interrupter.

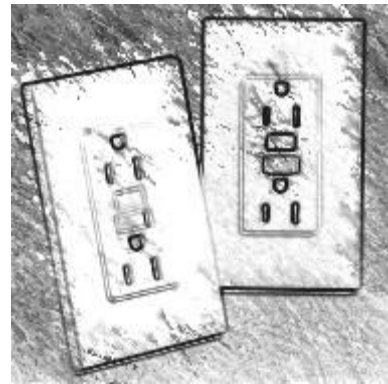

Do not disconnect the tool from the GFCI because it keeps on tripping (sometimes called “nuisance trips”). The GFCI IS operating properly. The reason for the GFCI “tripping” can usually be traced to electrical devices in need of repair, including the extension cords, or the tool or cord is being used in a wet or damp location.

A three-pronged plug or the wider spade terminal on the machinery/tool or the extension cord plug ensures that ungrounded devices (such as double insulated tools) are plugged in with the correct polarity. Never remove the ground pin (third prong) from the cord of a tool or three prong extension cord. This ground pin provides grounding protection and it also ensures that double insulated tools are plugged in with the correct polarity.

## ***Coordination of work activities***

Coordination of work activities means the employer must ensure hazards of a work activity do not affect the health or safety of adjacent workers who are engaged in a different work activity. For instance, if welders are generating welding fumes and it is not controlled at the source, it may be a hazard to adjacent workers who are working at a completely different task. Use of an effective exhaust system to control contaminants generated at a point source is a method that often works to protect the adjacent worker.

Some work, such as sandblasting, fibreglassing, or applying other coatings causes contaminants that are not localized but instead permeate the confined space. Sometimes, the dusts or vapours cannot be completely controlled by ventilation. The workers who are doing the work that is creating the contaminants must be protected from overexposure. Other crews could be scheduled at a different time so that other workers are not in the space during painting or fibreglassing. If that is not possible and there must be other workers inside the space, then they must be protected against overexposure.

It is critical that employers organize work activities ahead of time to prevent overlap of work areas and to prevent physical hazards from causing injuries to another group engaged in a different work activity inside the space. Restricting work areas by erecting barriers, retracting work times, and ensuring constant communication with all other adjacent work groups inside the space during work will help to prevent some common accidents (for example, being struck by falling materials, being struck by equipment or building materials, or tripping on cables or hoses that have been through the work area).

# Glossary

Where a term is defined in the occupational Health and Safety regulation, the section number containing the definition is included in parentheses. Other definitions give meaning of the term as used in this manual.

## ***Adjacent piping***

A device such as a pipe, line, or conduit which is connected to a confined space (section 9.1)

## ***Asphyxiant***

A vapour or gas that can cause unconsciousness or death by suffocation (lack of oxygen). There are two classes of asphyxiants: simple asphyxiants such as nitrogen or methane that act by replacing oxygen in the air, and chemical asphyxiants such as carbon monoxide that cause asphyxiation by preventing the body cells from using the oxygen in the blood.

## ***Auto-ignition temperature***

Temperature at which a flammable gas or vapour can catch fire without a source of ignition.

## ***Blank***

A solid plate installed through the cross-section of a pipe usually at a flanged connection (section 9.1).

## ***Blanking or blinding***

The absolute closure of adjacent piping, by fastening across its bore a solid plate or cap that completely covers the bore and is capable of withstanding the maximum pressure of the adjacent piping.

## ***Blind***

A solid plate installed at the end of a pipe that has at that point been physically disconnected from a piping system.

## ***Breathable air***

See *Clean respirable air*

### ***Clean respirable air***

When used to describe the atmosphere inside a confined space, means an atmosphere that is equivalent to clean, outdoor air and that contains:

- (a) about 20.9% percent oxygen by volume,
- (b) no measurable flammable gas or vapour as determined using a combustible gas measuring instrument, and
- (c) no air contaminant in concentrations exceeding either 10% of its applicable exposure limit in Part 5 of the Occupational Health and Safety Regulation or an acceptable ambient air quality standard established by an authority having jurisdiction over environmental air standards, whichever is greater (section 9.1)

### ***Confined space***

Except as otherwise determined by the Board\*, means an area, other than an underground working, that:

- (a) is enclosed or partially enclosed,
- (b) is not designed or intended for continuous human occupancy,
- (c) has limited or restricted means for entry or exit that may complicate the provision of first aid, evacuation, rescue, or other emergency response service, and
- (d) is large enough and is so configured that a worker could enter to perform assigned work (section 9.1).

Refer to the Guidelines for Part 9 of the OHS Regulation available at [WorkSafeBC.com](http://WorkSafeBC.com)

### ***Contaminant***

A harmful or irritant material, or nuisance dust, foreign to the normal composition of a substance, or a material that varies the normal proportions of components in a mixture such as air (section 1.1).

### ***Continuous monitoring***

Continuous atmospheric testing of a confined space, while workers are in the space, to identify concentrations of gas, oxygen, and explosives.

### ***CSA***

Canadian Standards Association

### ***Disconnecting***

Physically disconnecting (and misaligning) adjacent piping from a confined space to prevent its contents from entering the space in the event of discharge (section 9.1).

### ***Double block and bleed***

The closure of adjacent piping by locking out a drain or vent in the open position in the line between two locked out valves in the closed position (section 9.1).

### ***Due diligence***

Due diligence means taking all reasonable care to protect the well-being of employees or co-workers. To meet the standard of due diligence, you must take all precautions that are reasonable in the circumstances so that you can carry out your work and your health and safety responsibilities. This is the standard of care required with the Occupational Health and Safety Regulation.

### ***Entering a confined space***

A worker has entered a confined space when the worker's breathing zone breaks the plane of an opening into the confined space.

### ***Engineering controls***

The physical arrangement, design, or alteration of workstations, equipment, materials, production facilities, or other aspects of the physical work environment, for the purpose of controlling risk (section 1.1).

### ***Flammable gas***

A substance which meets the criteria for WHMIS Class B Division 1 flammable gas (a compressed gas with an upper flammable limit of 13% or less or with an explosive range or 12% or more) (section 1.1).

### ***Flange***

A protruding rim, edge, or collar, usually on a pipe, used to strengthen an object, hold it in place, or attach it to another object.

### ***Harmful substance***

A WHMIS controlled product, a substance referred to under section 5.48, or a substance that may have a harmful effect on a worker in a confined space (section 9.1).

## ***Hazard***

A thing or condition that may expose a person to the risk of injury or occupational disease (section 1.1.).

## ***Hazard assessment***

Hazard identification and risk assessment of a confined space conducted by the qualified person

## ***Hazardous substance***

See *Harmful substance*.

## **High-hazard atmosphere**

An atmosphere that may expose a worker to risk of death, incapacitation, injury, acute illness or otherwise impair the ability of the worker to escape unaided from a confined space, in the event of a failure of the ventilation system or respirator (section 9.1).

## ***IDLH atmosphere***

Mean an atmosphere containing a substance at a concentration that is immediately dangerous to life or health (IDLH) because the concentration is greater than that from which one could escape without any escape-impairing symptoms or irreversible health effects, and includes an atmosphere with an unknown concentration with the potential to be immediately dangerous to life or health (section 1.1).

## ***Inerting***

Intentionally flooding the inside of a confined space with an inert gas such as nitrogen to eliminate the hazard of ignition of flammable vapours inside the confined space but thereby creating an oxygen-deficient atmosphere (section 9.1).

## ***Intrinsically safe***

To ensure something is intrinsically safe refers to ensuring an electrical apparatus is designed so that it is unable to release sufficient energy, by either thermal or electrical means, to cause an ignition of a flammable gas.

## ***Lockout***

Means the use of a lock or locks to render machinery or equipment inoperable or to isolate an energy source in accordance with a written procedure (section 10.1).



### ***Low-hazard atmosphere***

An atmosphere that is shown by pre-entry testing or otherwise known to contain clean respirable air immediately prior to entry to a confined space and which is not likely to change during the work activity, as determined by the qualified person after consideration of the design, construction, and use of the confined space, the work activities to be performed, and all engineering controls required by the Occupational Health and Safety Regulation (section 9.1).

### ***Lower explosive limit (LEL)***

The minimum concentration of a combustible gas or vapour in air, expressed as a percentage by volume, that will ignite if a source of ignition is present (section 23.1) also known as lower flammable limit (LFL).

### ***Material safety data sheet or MSDS***

See *Safety Data Sheet*

### ***Mechanical ventilation***

Ventilation of a space with mechanical air movers (such as fans) or local exhaust systems and a means of directing the air, such as ductwork

### ***Moderate-hazard atmosphere***

An atmosphere that is not clean respirable air but is not likely to impair the ability of the worker to escape unaided from a confined space, in the event of a failure of the ventilation system or respirator (section 9.1).

### ***Natural ventilation***

Ventilation of a space by natural air movement resulting from wind or convection currents.

### ***NIOSH***

National Institute for occupational Safety and Health (in the United States)

### ***Oxygen deficient***

In relation to air, a condition in which there is less than 19.5% oxygen by volume, or the partial pressure of oxygen is less than 16.3kPa (122 mm Hg) (section 1.1).

### ***Purging***

The process of removing an unsafe atmosphere in a confined space and replacing it with clean respirable air.

### ***Qualified***

Being knowledgeable of the work, the hazards involved and the means to control the hazards, by reason of education, training, experience, or a combination thereof (definition in section 1.1).

### ***Rescue person***

A person who is properly equipped and adequately trained to perform rescue duties in confined space.

### ***Risk***

A chance of injury or disease (section 1.1).

### ***Safety Data Sheet (SDS)***

A document disclosing the information referred to in section 13(a)(i) to (v) of the *Hazardous Products Act* (Canada) and section 12(1) to (3) of the *Controlled Products Regulations* (Canada) (section 1.1).

### ***Standby person***

A person stationed outside a confined space whose responsibility is to check on the well-being of workers inside the space and initiate rescue in an emergency.

### ***Supervisor of the entry***

The person assigned responsibility for supervision of a confined space entry under section 9.7. Section 1.1 defines a supervisor as a person who instructs, directs, and controls workers in the performance of their duties.

### ***Ventilation***

See *Mechanical ventilation and Natural ventilation*.

### ***Venting***

Opening up a confined space to allow clean air to enter and circulate without the use of mechanical ventilation.

***Venturi effect***

Compressed air moving through a pipe that narrows causes a reduction of air pressure in the narrow part of the pipe. The reduction of air pressure results in air subsequently rushing in to fill the space. Air harms work on this principle. In a 16" model, input of 40 PSI @ 73 CFM might provide an output of 2,200 CFM.

***WHMIS***

Workplace Hazardous Materials Information System.